

Ethernet Analog PLC

C0-12DD1E-D

**4 DC Input (Sink/Source)/4 Sinking DC Output;
2 Analog Voltage/Current Input
2 Analog Voltage/Current Output Micro PLC**

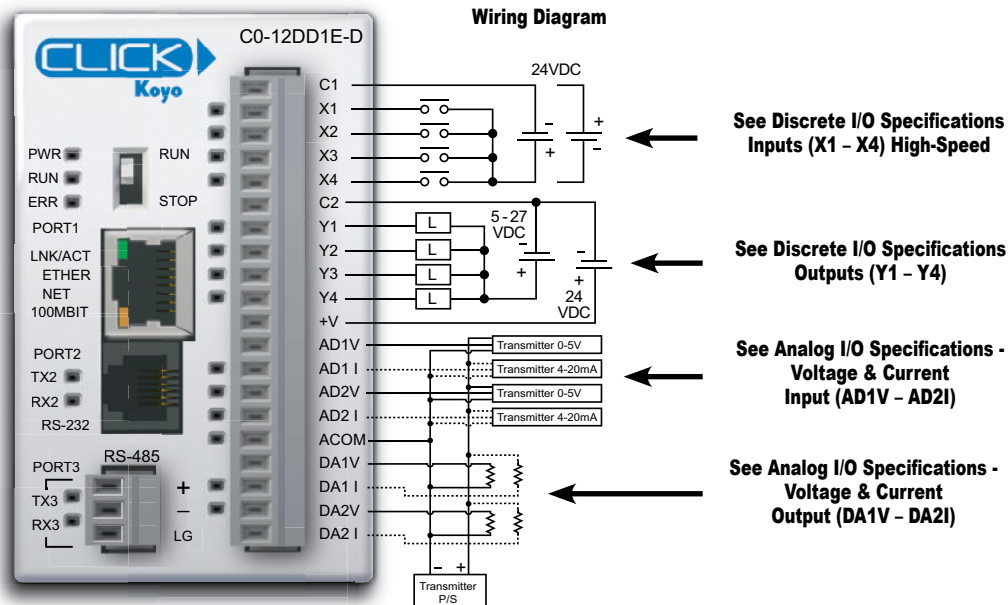

NOTE: There are no **ZIPLink** pre-wired PLC connection cables and modules for the Analog PLCs (cannot mix discrete I/O and analog I/O signals in a **ZIPLink** cable).
NOTE: When using Ethernet Analog PLCs, you must use CLICK programming software version V2.20 or later.



IMPORTANT: USE ONLY ONE TERMINAL (VOLTAGE OR CURRENT) PER CHANNEL. YOU MUST ALSO SELECT THE ANALOG TYPE (VOLTAGE OR CURRENT) IN THE CPU BUILT-IN I/O SETUP IN THE CLICK PROGRAMMING SOFTWARE (PULL-DOWN MENU SETUP > CPU BUILT-IN I/O SETUP).

General Specifications	
Current Consumption at 24VDC	140mA
Terminal Block Replacement Part No.	C0-16TB
Weight	5.1 oz (145g)

Ethernet Analog PLC

C0-12DD1E-D (cont'd)

X1 - X4 (High-Speed)

Discrete I/O Specifications - Inputs	
Inputs per Module	4 (Sink/Source)
Operating Voltage Range	24VDC
Input Voltage Range	21.6–26.4 VDC
Input Current	Typ 6.5 mA @ 24VDC
Maximum Input Current	7.0 mA @ 26.4 VDC
Input Impedance	3.9 kΩ @ 24VDC
Maximum Input Frequency	X1-X4: 100kHz
ON Voltage Level	> 19VDC
OFF Voltage Level	< 2VDC
Minimum ON Current	4.5 mA
Maximum OFF Current	0.5 mA
OFF to ON Response	Typ 3μs Max 5μs
ON to OFF Response	Typ 1μs Max 3μs
Status Indicators	Logic Side (4 points, green LED)
Commons	1 (4 points/common)

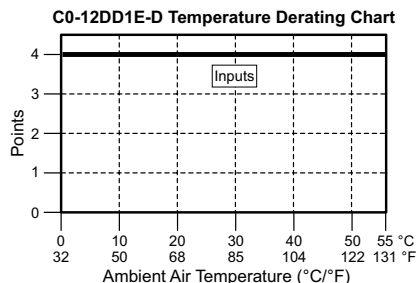
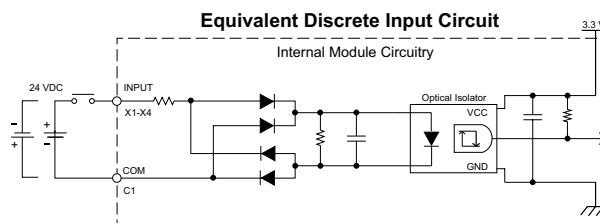

Y1 - Y4

Discrete I/O Specifications - Outputs	
Outputs per Module	4 (Sink)
Operating Voltage Range	5–27 VDC
Maximum Output Current	0.1 A/point; 0.4 A/common
Minimum Output Current	0.2 mA
Maximum Leakage Current	0.1 mA @ 30.0 VDC
On Voltage Drop	0.5 VDC @ 0.1 A
Maximum Inrush Current	150mA for 10ms
OFF to ON Response	< 5μs
ON to OFF Response	< 5μs
Status Indicators	Logic Side (4 points, red LED)
Commons	1 (4 points/common)
External DC Power Required	20–28 VDC Maximum @ 60mA (all points on)

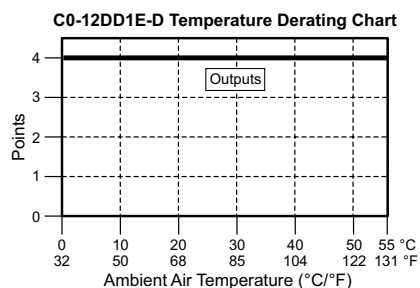
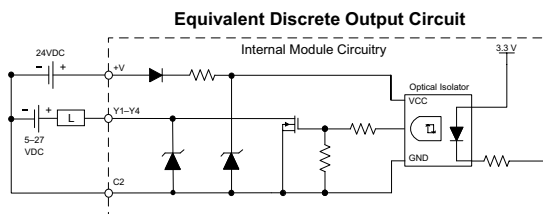

Ethernet Analog PLC

C0-12DD1E-D (cont'd)

AD1V - AD2V

Analog Specifications - Voltage Input	
Inputs per Module	2 (voltage/current selectable)
Input Range	0-5 VDC (6VDC Max.)
Resolution	12-bit
Conversion Time	50ms
Input Impedance	20kΩ
Input Stability	±2 LSB maximum
Full-Scale Calibration Error	±2% maximum
Offset Calibration Error	±25mV maximum
Accuracy vs. Temperature Error	±100ppm / °C maximum

Analog Voltage Input Circuit

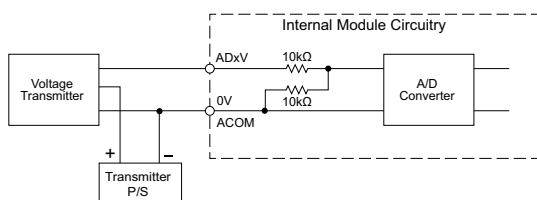

AD1I - AD2I

Analog Specifications - Current Input	
Inputs per Module	2 (voltage/current selectable)
Input Range	4-20 mA (sink)
Resolution	12-bit
Conversion Time	50ms
Input Impedance	125Ω
Input Stability	±2 LSB
Full-Scale Calibration Error	±2% maximum
Offset Calibration Error	±0.1 mA maximum
Accuracy vs. Temperature Error	±100ppm / °C maximum

Analog Current Input Circuit

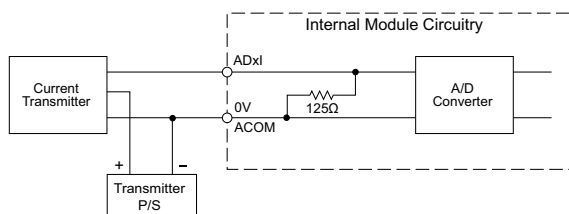

DA1V - DA2V

Analog Specifications - Voltage Output	
Outputs per Module	2 (voltage/current selectable)
Output Range	0-5 VDC
Resolution	12-bit
Conversion Time	1ms
Load Impedance	2kΩ minimum (output current 2.5 mA maximum)
Full-Scale Calibration Error	±2% maximum
Offset Calibration Error	±25mV maximum
Accuracy vs Temperature Error	±100ppm / °C maximum

Analog Voltage Output Circuit

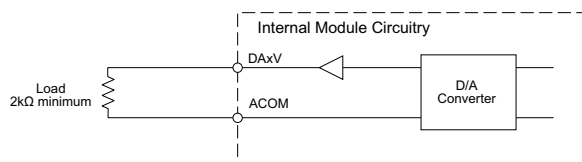

DA1I - DA2I

Analog Specifications - Current Output	
Outputs per Module	2 (voltage/current selectable)
Output Range	4-20 mA (sink)
Resolution	12-bit
Conversion Time	1ms
Loop Supply Voltage	DC 18-30 V
Load Impedance	250 ohms Load Power Supply: DC 18V: 600Ω maximum DC 24V: 900Ω maximum DC 30V: 1200Ω maximum
Full-Scale Calibration Error	±2% maximum
Offset Calibration Error	±25mA maximum
Accuracy vs Temperature Error	±100ppm / °C maximum

Analog Current Output Circuit

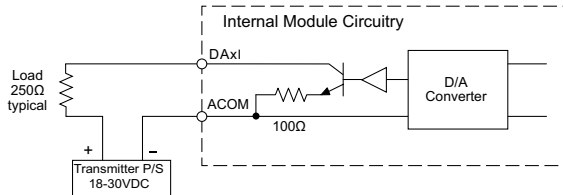

CLICK PLC Specifications

General Specifications For All CLICK PLC Products

These general specifications apply to all CLICK PLCs and optional power supply products. Please refer to the appropriate I/O temperature derating charts under both the PLC and I/O module specifications to determine best operating conditions based on the ambient temperature of your particular application.

General Specifications	
Operating Temperature	Analog, analog combo I/O modules only: 32°F to 140°F (0°C to 60°C); All other modules: 32°F to 131°F (0°C to 55°C), IEC 60068-2-14 (Test Nb, Thermal Shock)
Storage Temperature	-4°F to 158°F (-20°C to 70°C) IEC 60068-2-1 (Test Ab, Cold) IEC 60068-2-2 (Test Bb, Dry Heat) IEC 60068-2-14 (Test Na, Thermal Shock)
Ambient Humidity	30% to 95% relative humidity (non-condensing)
Environmental Air	No corrosive gases. Environmental pollution level is 2 (UL840)
Vibration	MIL STD 810C, Method 514.2, EC60068-2-27, Category [f], Procedure[VIII] JIS C60068-2-27 (Sine wave vibration test)
Shock	MIL STD 810C, Method 516.2, IEC60068-2-27, JIS C60068-2-27, Category [f], Procedure[VIII]
Noise Immunity	<EN61131-2> EN61000-4-2 (ESD) EN61000-4-3 (RFI) EN61000-4-4 (FTB) EN61000-4-5 (Surge) EN61000-4-6 (Conducted) EN61000-4-8 (Power frequency magnetic field immunity) <Local Test> Impulse noise 1µs, 1000V RFI: No interference measured at 150 and 450 MHz (5w/15cm)
Emissions	EN55011:1998 Class A; EN61000-6-4:2007+A1:2011
Agency Approvals	UL508, UL61010-2-201 (File No. E157382, E316037); CE (EN61131-2); CUL Canadian C22.2
Other	RoHS 2011/65/EU Amendment (EU)2015/863

CLICK PLC Specifications

PLC Unit Specifications

Basic, Standard and Analog PLC Unit Specifications			
	<i>Basic PLC</i>	<i>Standard PLC</i>	<i>Analog PLC</i>
Control Method	Stored Program/Cyclic execution method	Stored Program/Cyclic execution method	Stored Program/Cyclic execution method
I/O Numbering System	Fixed in Decimal	Fixed in Decimal	Fixed in Decimal
Ladder Memory (steps)	8000	8000	8000
Total Data Memory (words)	8000	8000	8000
Contact Execution (Boolean)	< 0.6 us	< 0.6 us	< 0.6 us
Typical Scan (1K Boolean)	1-2 ms	1-2 ms	1-2 ms
RLL Ladder Style Programming	Yes	Yes	Yes
Run Time Edits	No	No	No
Scan	Variable / fixed	Variable / fixed	Variable / fixed
CLICK Programming Software for Windows	Yes	Yes	Yes
Built-in Communication Ports	Yes (two RS-232 ports)	Yes (two RS-232 ports and one RS-485 port)	Yes (two RS-232 ports and one RS-485 port)
Protocols	Protocols: Modbus RTU (master/slave) and ASCII (in/out)		
FLASH Memory	Standard on PLC	Standard on PLC	Standard on PLC
Built-in Discrete I/O points	8 inputs, 6 outputs	8 inputs, 6 outputs	4 inputs, 4 outputs
Built-in Analog I/O Channels	No	No	2 inputs, 2 outputs
Number of Instructions Available	21	21	21
Control Relays	2000	2000	2000
System Control Relays	1000	1000	1000
Timers	500	500	500
Counters	250	250	250
Interrupts	Yes (external: 8 / timed: 4)	Yes (external: 8 / timed: 4)	Yes (external: 4 / timed: 4)
Subroutines	Yes	Yes	Yes
For/Next Loops	Yes	Yes	Yes
Math (Integer and Hex)	Yes	Yes	Yes
Drum Sequencer Instruction	Yes	Yes	Yes
Internal Diagnostics	Yes	Yes	Yes
Password Security	Yes	Yes	Yes
System Error Log	Yes	Yes	Yes
User Error Log	No	No	No
Memory Backup	Super Capacitor	Super Capacitor + Battery	Super Capacitor + Battery
Battery Backup	No	Yes (battery sold separately; part # D2-BAT-1)	Yes (battery sold separately; part # D2-BAT-1)
Calendar/Clock	No	Yes	Yes
I/O Terminal Block Replacement	AutomationDirect p/n C0-16TB	AutomationDirect p/n C0-16TB	AutomationDirect p/n C0-16TB
Communication Port & Terminal Block Replacement	N/A	AutomationDirect p/n C0-3TB	AutomationDirect p/n C0-3TB
24VDC Power Terminal Block Replacement	AutomationDirect p/n C0-4TB	AutomationDirect p/n C0-4TB	AutomationDirect p/n C0-4TB

CLICK PLC Specifications

PLC Unit Specifications (continued)

Ethernet Basic, Standard and Analog PLC Unit Specifications			
	<i>Ethernet Basic PLC</i>	<i>Ethernet Standard PLC</i>	<i>Ethernet Analog PLC</i>
Control Method	Stored Program/Cyclic execution method	Stored Program/Cyclic execution method	Stored Program/Cyclic execution method
I/O Numbering System	Fixed in Decimal	Fixed in Decimal	Fixed in Decimal
Ladder Memory (steps)	8000	8000	8000
Total Data Memory (words)	8000	8000	8000
Contact Execution (Boolean)	< 0.2 μ s	< 0.2 μ s	< 0.2 μ s
Typical Scan (1K Boolean)	< 1ms	< 1ms	< 1ms
RLL Ladder Style Programming	Yes	Yes	Yes
Run Time Edits	Yes	Yes	Yes
Scan	Variable / fixed	Variable / fixed	Variable / fixed
CLICK Programming Software for Windows	Yes	Yes	Yes
Built-in Communication Ports	Yes (one Ethernet port and one RS-232 port)	Yes (one Ethernet port, one RS-232 port and one RS-485 port)	Yes (one Ethernet port, one RS-232 port and one RS-485 port)
Protocols	Modbus RTU (master/slave) and ASCII (in/out), Modbus TCP (client/server), EtherNet/IP Implicit and Explicit (adapter server)		
FLASH Memory	Standard on PLC	Standard on PLC	Standard on PLC
Built-in Discrete I/O points	8 inputs, 6 outputs	8 inputs, 6 outputs	4 inputs, 4 outputs
Built-in Analog I/O Channels	No	No	2 or 4 inputs; 2 outputs
Number of High-Speed Input Points	4	8	4
Number of High-Speed Counters	4	6	4
PID Control Loops	8	8	8
Number of Instructions Available	21	21	21
Control Relays	2000	2000	2000
System Control Relays	1000	1000	1000
Timers	500	500	500
Counters	250	250	250
Interrupts	Yes (external: 8 / timed: 4)	Yes (external: 8 / timed: 4)	Yes (external: 4 / timed: 4)
Subroutines	Yes	Yes	Yes
For/Next Loops	Yes	Yes	Yes
Math (Integer and Hex)	Yes	Yes	Yes
Drum Sequencer Instruction	Yes	Yes	Yes
Internal Diagnostics	Yes	Yes	Yes
Password Security	Yes	Yes	Yes
System Error Log	Yes	Yes	Yes
User Error Log	No	No	No
Memory Backup	Super Capacitor + Battery	Super Capacitor + Battery	Super Capacitor + Battery
Battery Backup	Yes (battery part # D2-BAT-1)	Yes (battery part # D2-BAT-1)	Yes (battery part # D2-BAT-1)
Calendar/Clock	Yes	Yes	Yes
I/O Terminal Block Replacement	AutomationDirect p/n C0-16TB	AutomationDirect p/n C0-16TB	AutomationDirect p/n C0-16TB
Communication Port & Terminal Block Replacement	N/A	AutomationDirect p/n C0-3TB	AutomationDirect p/n C0-3TB
24VDC Power Terminal Block Replacement	AutomationDirect p/n C0-4TB	AutomationDirect p/n C0-4TB	AutomationDirect p/n C0-4TB

CLICK Specifications

CLICK PLC Hardware/Software Compatibility

CLICK PLCs require a minimum software version of v2.50 for the PID function. The table below shows the most recent software and hardware versions required for the High-Speed input operation capability to be accessible.

CLICK PLC Features Software Compatibility							
CPU Type	Part Number	Minimum CLICK Software Version					
		Hardware	High-Speed Inputs	EtherNet/IP	PID	DHCP	
Basic	C0-00DD1-D	v1.00	N/A	N/A	N/A	N/A	
	C0-00DD2-D						
	C0-00DR-D						
	C0-00AR-D						
Standard	C0-01DD1-D	v1.20	N/A	N/A	N/A	N/A	
	C0-01DD2-D						
	C0-01DR-D						
	C0-01AR-D						
Analog	C0-02DD1-D (before SN 171208001)	v1.12	N/A	N/A	N/A	N/A	
	C0-02DD1-D (after SN 171208001)	v2.10					
	C0-02DD2-D (before SN 174018001)	v1.12					
	C0-02DD2-D (after SN 174018001)	v2.10					
	C0-02DR-D (before SN 173158001)	v1.12					
	C0-02DR-D (after SN 173158001)	v2.10					
Ethernet CPUs Ethernet CPUs require v2.40 for EtherNet/IP communications							
Ethernet Basic	C0-10DD1E-D	v2.00	v2.30	v2.40	v2.50	v3.00	
	C0-10DD2E-D						
	C0-10DRE-D		N/A				
	C0-10ARE-D						
Ethernet Standard	C0-11DD1E-D	v2.00	v2.30	v2.40	v2.50	v3.00	
	C0-11DD2E-D						
	C0-11DRE-D		N/A				
	C0-11ARE-D						
Ethernet Analog	C0-12DD1E-D	v2.20	v2.30	v2.40	v2.50	v3.00	
	C0-12DD2E-D						
	C0-12DRE-D		N/A				
	C0-12ARE-D						
	C0-12DD1E-1-D		v2.30				
	C0-12DD2E-1-D						
	C0-12DRE-1-D		N/A				
	C0-12ARE-1-D						
	C0-12DD1E-2-D		v2.30				
	C0-12DD2E-2-D						
	C0-12DRE-2-D		N/A				
C0-12ARE-2-D							
I/O Modules	C0-08NE3	v1.20	N/A	N/A	N/A	N/A	
	C0-16NE3						
	C0-04AD-1	v1.40					
	C0-04AD-2						
	C0-04DA-1						
	C0-04DA-2						
	C0-4AD2DA-1						
	C0-4AD2DA-2						
	C0-04RTD						
	C0-04THM						
	C0-08CDR						
	C0-16CDD1						
	C0-16CDD2						
	Other modules						v1.00

CLICK PLC Family Overview

What you'll need

Of course, what you'll need for your system depends on your particular application, but this overview shows you what you'll need for a simple system.

1. Select your CLICK or CLICK PLUS PLC unit.



2. If using a CLICK PLUS PLC, select an Option Slot Module if desired.

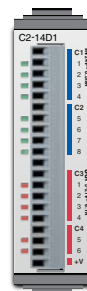

3. If you need additional I/O, select from 24 different types of Stackable I/O modules.



4. Select a 24VDC power supply.



or



5. Download the FREE CLICK programming software. support.automationdirect.com/products/clickplcs.html



6. Download the FREE CLICK mobile app. The CLICK mobile app is available for iOS and Android. It can connect to your C2-02CPU or C2-03CPU over Bluetooth to provision the PLC onto a Wi-Fi network. (PLC requires an external antenna)



CLICK PLC Family Overview

What you'll need (continued)

7. Select your PC-to-PLC programming cable.

If your PC has a USB port, use cable [EA-MG-PGM-CBL](#) to connect to the PLC port. If your PC has a 9-pin serial communications port, use programming cable [D2-DSCBL](#). If your PC has an Ethernet port, use [C5E-STPYL-C3](#) (crossover) or [C5E-STPYL-S3](#) (straight through) Ethernet cable. If your PC is on a network with a wireless access point, you can connect using one of our Wi-Fi antennas.

[USB-CBL-AMICB6](#)



**USB A to USB micro B
Programming Cable Assembly
(CLICK PLUS Only)**

**[C5E-STPYL-C3](#) (crossover)
[C5E-STPYL-S3](#) (straight through)**



For Ethernet PLC Unit

OR

**[SE-ANT250](#)
Wi-Fi/Bluetooth Dome Antenna
([C2-02CPU](#) & [C2-03CPU](#) only)**



OR

**[SE-ANT210](#)
Wi-Fi/Bluetooth Whip Antenna
([C2-02CPU](#) & [C2-03CPU](#) only)
(nonmetal enclosure only)**



[D2-DSCBL](#)



**(PC requires RS-232 port
to use this cable)**

OR

[EA-MG-PGM-CBL](#)



Connects to PC USB Port

8. Select tools, wire, and provide power.

**Screwdriver
[TW-SD-MSL-2](#)**



**Wire Strippers
[DN-WS](#)**



Hookup Wire



Power Supplies

Power Supplies

The CLICK PLC family offers two 24VDC power supplies. They are identical except for the output current.

It is not mandatory to use one of these CLICK power supplies for the CLICK/CLICK PLUS PLC system. You can use any other 24VDC power supply that AutomationDirect.com offers, including the PSP24-DC12-1 12 to 24 VDC converter shown below.

CO-00AC Power Supply

Limited auxiliary AC power supply allows you to power the 24VDC CLICK C0 and C2 series PLCs with 100–240 VAC supply power. The 0.5 A DC power supply is capable of controlling the PLC plus a limited configuration based on the power budget of each I/O module. The CO-00AC is a low-cost solution for applications requiring only minimal I/O and power consumption. This power supply will not support a fully-populated CLICK PLC system with all possible I/O module combinations.

CO-01AC Power Supply

Expanded auxiliary AC power supply allows you to power the 24VDC CLICK C0 and C2 series PLCs with 100–240 VAC supply power. The 1.3 A DC power supply is capable of supporting a fully-populated CLICK PLC system with all possible I/O module combinations, with no concerns for exceeding the power budget.

PSP24-DC12-1 DC-DC Converter

With this DC-DC converter you can operate the CLICK/CLICK PLUS PLC with 12VDC input power.

CO-00AC



CO-01AC



CLICK 24VDC Power Supply Ratings

Part Number	Output Current	Price
CO-00AC	0.5 A	
CO-01AC	1.3 A	

CO-00AC Power Supply Input Specifications

Part Number	CO-00AC	CO-01AC
Input Voltage Range	85–264 VAC	
Input Frequency	47–63 Hz	
Input Current (typical)	0.3 A @ 100VAC, 0.2 A @ 200VAC	0.9 A @ 100VAC, 0.6 A @ 200VAC
Inrush Current	30A	
Efficiency	80% typical	

CO-00AC Power Supply Output Specs

Part Number	CO-00AC	CO-01AC
Output Voltage Range	23–25 VDC	
Output Current	0.5 A	1.3 A
Ripple	200mV p-p max (0–55°C)	
Ripple Noise	300mV p-p max (0–55°C)	
Over Current Protection	@ 0.65 A (automatic recovery)	@ 1.6 A (automatic recovery)
Over Voltage Protection	@ 27.6 V (clamped by Zener diode)	
Start-up Time	1000ms max at rated input and load	
Hold-up Time	10ms minimum at 85VAC, I=max	

CO-00AC Power Supply General Specs

Part Number	CO-00AC	CO-01AC
Ambient Operating Temperature	32–131°F [0–55°C]	
Storage Temperature	–4–158°F [–20–70°C]	
Humidity	30–95%, non-condensing	
Vibration Resistance	JIS C60068-2-6, sine wave vibration	
Shock Resistance	JIS C60068-2-27	
Voltage Withstand		
Input-Output	1500VAC, 5mA cutoff current	
Input-Ground	1500VAC, 5mA cutoff current	
Output-Ground	500VAC, 5mA cutoff current	
Insulation Resistance		
Input-Output	10MΩ minimum, 500VDC	
Input-Ground	10MΩ minimum, 500VDC	
Output-Ground	5MΩ minimum, 500VDC	
Noise Immunity	FCC Class A, EN55022:1998 Class A	
Input/Output Interface	5P terminal block, Fujicon UF2362AX series or equivalent	
Agency Approvals	UL508, UL1604, EN61010-1 (IEC 1010-1), CAN/CSA E60079-15:02, JIS C0025	
Weight	5.3 oz [150g]	6.0 oz [170g]

PSP24-DC12-1 DC-DC Converter Specs

Input Voltage Range	9.5–18 VDC
Input Power (no load)	1.0 W max.
Startup Voltage	8.4 VDC
Undervoltage Shutdown	7.6 VDC
Output Voltage Range	24–28 VDC (adjustable)
Output Current	1.0 A
Short Circuit Protection	Current limited at 110% typical
Weight	7.5 oz (213g)

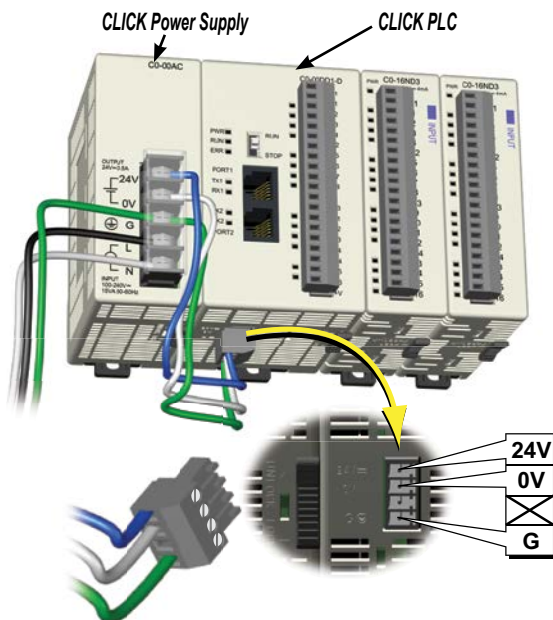

24VDC power is supplied to the PLC unit through wiring connected from the power supply output to the 4-pin 24VDC input connector located on the bottom of the PLC unit.



PSP24-DC12-1

Accessories

C2-USER-M

CLICK PLUS PLC Hardware User Manual

Manual covers all CLICK PLUS PLC and I/O module installation and wiring, specifications, error codes and troubleshooting guide. The CLICK PLUS PLC Hardware User Manual can be downloaded free at the AutomationDirect Web site; www.automationdirect.com



C0-USER-M

CLICK PLC Hardware User Manual

Manual covers all CLICK PLC and I/O module installation and wiring, specifications, error codes and troubleshooting guide. The CLICK PLC Hardware User Manual can be downloaded free at the AutomationDirect Web site; www.automationdirect.com



C0-PGMSW

Programming Software CD-ROM

The programming software can be downloaded free at the AutomationDirect Web site, or the CD can be purchased from the AutomationDirect online Web store. www.automationdirect.com



EA-MG-PGM-CBL

PC to Panel Programming Cable Assembly for C-more Micro-Graphic Panels and CLICK/CLICK PLUS PLCs

The 6ft cable assembly connects a personal computer to any **C-more** Micro-Graphic panel, CLICK PLC, or select CLICK PLUS PLC for setup and programming.

Note: This cable assembly uses the PC's USB port and converts the signals to serial transmissions. The USB port supplies 5VDC to the Micro-Graphic panel for configuration operations.

Assembly includes standard USB A-type connector to B-type connector cable, custom converter, and a RS232C cable with RJ12 modular connector on each end.



USB-CBL-AMICB6

USB A to USB micro B Programming Cable Assembly (CLICK PLUS Only)

Programming Cable, USB A to USB micro B, 6ft. (1.83 m) length. For use with CLICK PLUS PLCs and most USB devices. The USB port supplies 5VDC to the CLICK PLUS CPU for programming.



D2-DSCBL

Programming Cable for CLICK/CLICK PLUS and DirectLOGIC PLCs

12ft. (3.66 m) RS232 shielded PC programming cable for CLICK, select CLICK PLUS PLCs, DL05, DL06, DL105, DL205, D3-350, D4-450, D4-454, and Do-more H2 and T1H series CPUs. 9-pin D-shell female connector to an RJ12 6P6C connector.



Note: If your PC has a USB port but does not have a serial port, you must use programming cable [EA-MG-PGM-CBL](#) to connect to CLICK PLCs. For CLICK PLUS PLCs, you may also use [USB-CBL-AMICB6](#)

C0-3TB

Spare 3-Pole Terminal Block

Replacement 3-pole terminal block for the 3-wire RS-485 Port 3 on CLICK Standard and Analog PLCs as well as the CLICK PLUS [C2-03CPU](#). Sold in packs of 2.



C0-4TB

Spare 24VDC Power Terminal Block

Replacement terminal block for the 24VDC supply power to the PLC. Sold in packs of 2.

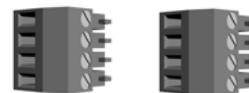

C0-8TB

Spare 8-Point I/O Terminal Block

Replacement terminal block for the 8-point I/O modules. Sold in packs of 2.

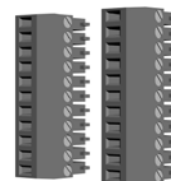

C0-8TB-1

Spare 13-Point I/O Terminal Block

Replacement terminal block for the 8-point I/O relay modules. Sold in packs of 2.



C0-16TB

Spare 16-Point I/O Terminal Block

Replacement terminal block for the 16-point I/O modules and PLC built-in I/O. Sold in packs of 2.

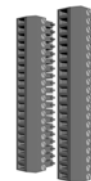

Accessories

SE-ANT250

Wi-Fi/Bluetooth Dome Antenna
2.4 GHz antenna, IP67, panel mount, 9.8ft (3m) cable length, for external mounting when CLICK PLUS PLC is installed in a metallic enclosure.



C2-FILL

CPU Option Slot Cover
Snap-on cover for CLICK PLUS CPU Option Slot in applications without an Option Slot module present.

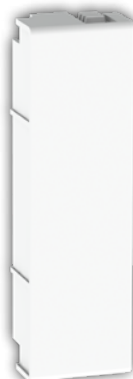

SE-ANT210

Wi-Fi/Bluetooth Whip Antenna
Whip/straight 2.4 GHz antenna, IP65, connector mount. Not recommended for installation in a metallic enclosure.



D2-BAT-1

Replacement battery for Standard, Analog, Ethernet Standard and Ethernet Analog PLC units.



DN-EB35MN

DINector End Bracket



D0-MC-BAT

Replacement battery for CLICK PLUS PLC units.



C-more and C-more Micro Graphic Operator Interfaces



DN-WS

Wire Stripper



ZIPLink Wiring Systems



TW-SD-MSL-2

Insulated Slotted Screwdriver
0.4 x 2.5 x 80 mm slotted screwdriver for terminal blocks.

