

# C-more Computer Programming Connections

For new applications choose EA9 series C-more panels, part numbers EA9-TxCL(-R).

Using the C-more Programming Software for project development, the touch panel can be connected to a PC (personal computer) in one of several ways:

- Connect a USB Programming Cable such as (USB-CBL-AB15) from a USB port type A on the PC to the USB type B programming port on the C-more touch panel. The USB connection is for direct connection only and does not support USB hubs.
- Connect the C-more touch panel to a PC via an Ethernet hub or switch, and CAT5 Ethernet cables (full feature panels only). Multiple panels can be programmed in this configuration.
- Use an Ethernet crossover cable directly between the C-more touch panel's Ethernet port and the PC Ethernet port (full feature panels only).

Following are the minimum system requirements for running C-more Programming Software (p/n EA-PGMSW) on a PC:

- Personal Computer with a 333 MHz or higher processor (CPU) clock speed recommended; Intel® Pentium/Celeron family, or AMD® K6/Athlon/Duron family, or compatible processor recommended
- Keyboard and Mouse or compatible pointing device
- Super VGA color video adapter and monitor with at least 800 x 600 pixels resolution (1024 x 768 pixels recommended) 64K color minimum
- 300 MB free hard-disk space
- 128 MB free RAM (512 MB recommended); 512 MB free RAM (1 GB recommended) for Vista
- CD-ROM or DVD drive for installing software from the CD
- USB port or Ethernet 10/100 Mbps port for project transfer from software to touch panel (Ethernet port not available on -R models)
- Operating System - Windows® XP Home / Professional Edition with Service Pack 2, Windows® 2000 with Service Pack 4, Windows® Vista, Windows® 7 or Windows® 8.

## USB Connectivity

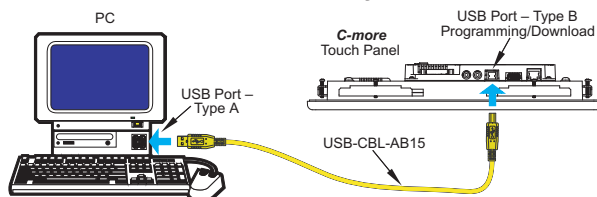

## Ethernet Connectivity via a Hub or Switch

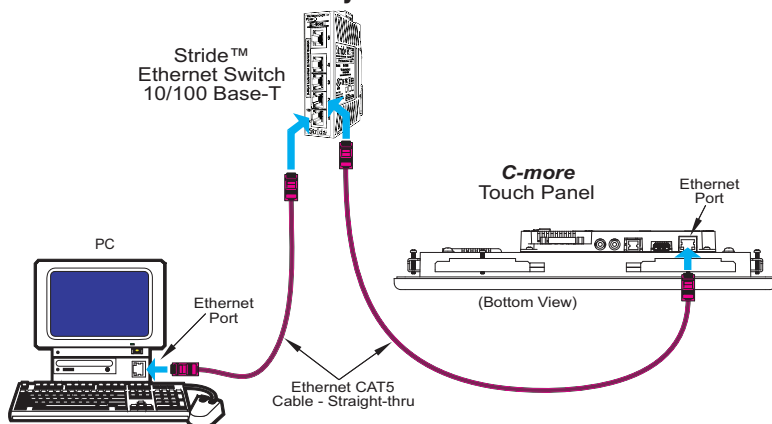

## Ethernet Direct Connection

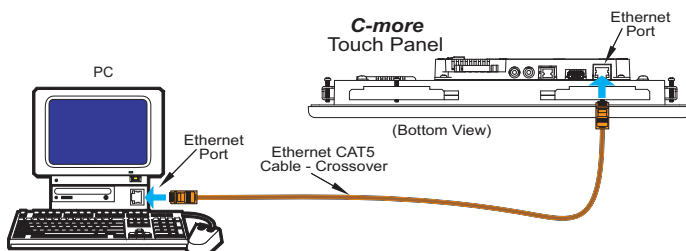

## USB Programming Cable



Part No. USB-CBL-AB15



Other lengths available see USB-CBL-AB3, USB-CBL-AB6, USB-CBL-AB10 on page 9-27

## Stride™ Ethernet Switch



Part No. SE-SW5U



## Ethernet Configuration Kit



Part No. RT-CNFGKIT



The Ethernet Configuration Kit includes a five-port 10/100 Base-T Ethernet switch, four straight-through cables, and one crossover cable. (The cables are at least five feet in length.) The kit provides a great convenience for configuring systems, demonstration systems or basic control projects using Ethernet.

# User-friendly Configuration Software

## Simpler yet more powerful

**C-more's** mission is to make you feel like a touch panel configuration expert. So we put in many tools to make your job faster and more effective. Even simple things, such as object configuration boxes, have improved. We think you'll be able to do more with **C-more** in even less time!

Save your screens in the Screen Library to use with other projects

Build your own keypads to use with numeric and text entry

Click on the **Library** tab to view libraries of personally stored objects, screens, sound bites, etc. **This saves hours of work!**

Thumbnail project preview window helps you organize multiscreen projects. And you can rearrange the screens using the screen library!

Scrolling object selection window lets you find the object you want fast. **Just drag and drop it on the screen.**

Scrolling parts list shows variations of the objects selected above. **Just drag and drop on the screen.**

Scrolling help window for each object type selected

Select background screen, background color, and screen layering with a click!

### HELP!



Hardware manuals and help files are a few clicks away. There are also numerous help screens that clearly show you all the functions of each selection. Need more? Follow the links to **C-more's** online library of objects and sound bites, or visit **C-more's** online forum.

### Object Configuration Screen lets you quickly configure objects with fill-in-the-blank point-and-click ease

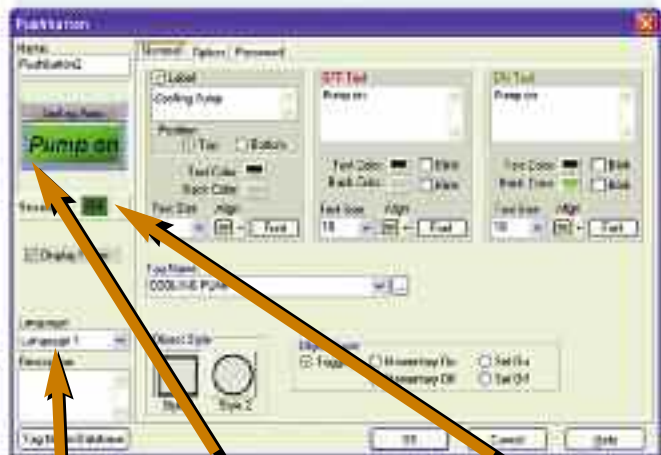

Set up text for up to nine different languages on each object

Preview object as it is being configured

Simulate object while it is being configured



- Company Information
- Systems Overview
- Programmable Controllers
- Field I/O
- Software
- C-more & other HMI**
- Drives
- Soft Starters
- Motors & Gearbox
- Steppers/Servos
- Motor Controls
- Proximity Sensors
- Photo Sensors
- Limit Switches
- Encoders
- Current Sensors
- Pressure Sensors
- Temperature Sensors
- Pushbuttons/Lights
- Process
- Relays/Timers
- Comm.
- Terminal Blocks & Wiring
- Power
- Circuit Protection
- Enclosures
- Tools
- Pneumatics
- Safety
- Appendix
- Product Index
- Part # Index

# Create Detailed Objects

## See the difference

C-more's objects look professional since they can use a wide variety of refined graphics, flexible fonts, color gradients, up to 65,536 colors and overlapping objects. Your objects will be more realistic and recognizable, almost true to life!

Customize the background colors and fonts to make your selector switch look more modern, especially with the wide range of fonts

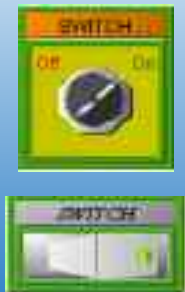

Various shading options on all standard objects allows a more realistic look.



Overlapping objects allows you to create great looking custom objects like this combination of a bitmap and meter.



Use "special effects," such as cutaway bar graphs, with your own bitmaps



Refined Graphics    More Fonts and Typefaces    Color Gradients    Overlapping Objects    65,536 Colors



## Common-sense editing tools

Use the common-sense editing tools similar to those found in office environment presentation software packages - group, order, nudge, rotate, flip, font up/down, and undo all reduce configuration time.

## Use common elements across screens

Create a control bar once (like the one at the top of the screen shown below). With a few clicks of your mouse, it can be used as a background screen on all relevant screens. Imagine the time saved!



## Power User for global changes

On the main configuration screen, click on View and select the Property List as an alternative "Power User" object configuration/editing tool. Similar to Visual Basic®, the property list dialog box allows power users to quickly configure or make changes to C-more objects. Perfect for an array of similar objects, just copy one object several times and then use the property box to make a few changes. Select multiple objects and change all of them at once. Common properties of different types of objects can even be edited simultaneously, such as background or text color.



# Better Fonts and Animation

## More built-in fonts

**C-more** has 14 different fonts for objects such as pushbuttons, indicators, meters and so on. These fonts are used for object-integrated labels and ON/OFF phrases for each of **C-more**'s standard objects. Each font can be bolded, italicized and underlined. Fonts can be scaled to hundreds of sizes, giving you extreme flexibility.



Object Fonts

Need even more fonts? Use any of the dozens from your PC as "Bitmap Text". (Although bitmap text cannot be used as an integral part of standard objects, they can be used for a wide variety of static annotations.)



Bitmap Text Fonts

## Built-in animation makes the process come to life

Virtually any bitmap object (from your PC hard drive, the built-in 4,000 symbol library, custom-drawn, etc.) can be animated to follow a straight line or a scribbled path. In addition, the object can change size or orientation (rotation).

Of course, the object can also do any combination of actions as well. Best of all, the animation process is very straightforward. You will be animating your first object in as little as a few minutes!

## 5 types of animation (any combination)

- **Straight line... X or Y**
- **Scribbled path with up to 64 points**
- **Rotational**
- **Change size**
- **Multi-State Bitmap**



A bitmap object (picture of cardboard box) follows a curving path along a conveyor (the path can be hidden). The box can rotate around the bends in the path and even change sizes. The bitmap changes toward the end to a closed box shape.

### Axis Animation:

PLC tag values dictate the actual screen position of an object. Move objects along a single axis or use different tags for simultaneous X-Y position control.

### Point Animation:

Define a path with up to 64 points for point-to-point object motion, or use "ratio" mode to move smoothly along a path. Scaling of PLC tag values to the path positions is optional.

### Object Rotation:

Control rotation of an object based on the value of a PLC tag. Also allows scaling of tag values to angular values.

### Object Size:

Control the size of an object based on PLC tag values. Independent X and Y-axis scaling of object size is possible, along with scaling of the tag values.

### Multi-State Bitmap:

Use up to 16 different bitmap images to animate changes in the appearance of an object.

### Benefit:

Animations of machine motion and factory processes enhance comprehension, and give operators a visual representation of the desired motion of products, and machinery on screen.

# Better Trends and More Control Options

## Improved trends, new PID faceplate, true historical data logging

**C-more's** trend graph supports 16 pens, selectable to be hidden or shown by the operator. Show only the trends you wish to see, when you wish to see them. In addition, the full featured **C-more** units support data logging to CompactFlash cards or USB memory devices. Gigabytes of trend data can be stored, limited only by you. The information can also be sent

from **C-more** to your PC over the Internet, triggered by an event. **C-more** also has the standard PID faceplate and an enhanced version which shows trend data of the setpoint process variable and control variable. (Base panels support data logging to USB only.)

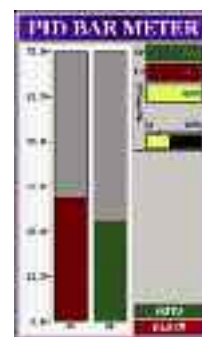

- 16 pen trends
- PID faceplate
- PID with trend faceplate
- Each pen can be turned on/off
- True historical data logging

### Log to CompactFlash/USB



## Pop-up windows for information and control

Use Pop-up Window Frames to overlay information or to provide extra controls on top of other screens. Operators can reposition the pop-up anywhere on the screen or close the pop-up when no longer required. Pop-up windows are created just like the other objects in the project, and can include a portion of any **C-more** screen (except other Pop-ups - no cascading available).



## Pop-up Message Boxes for critical events

Create Pop-up Message Boxes in the Event Manager. You define the trigger criteria, and then select "Message Box" as the "action". You can type in a short message to appear in the box, and select an icon to display with your message. You can even include tag data, and date/time information in the message. The operator must click the OK button in order to clear the message box. You can also log an alarm at the same time the message box is activated via the event manager (along with many other actions).

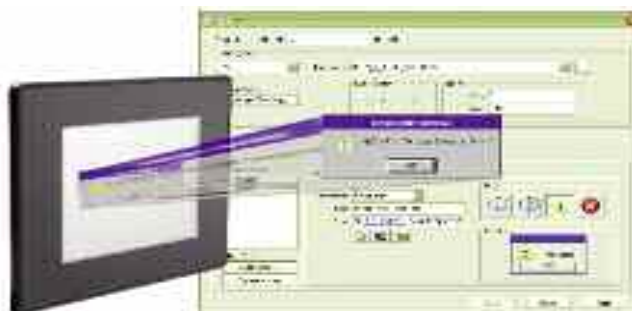

Company Information

Systems Overview

Programmable Controllers

Field I/O

Software

C-more & other HMI

Drives

Soft Starters

Motors & Gearbox

Steppers/Servos

Motor Controls

Proximity Sensors

Photo Sensors

Limit Switches

Encoders

Current Sensors

Pressure Sensors

Temperature Sensors

Pushbuttons/Lights

Process

Relays/Timers

Comm.

Terminal Blocks & Wiring

Power

Circuit Protection

Enclosures

Tools

Pneumatics

Safety

Appendix

Product Index

Part # Index

# Wide Array of Objects and Customized Parts

Here are just a few of the more than 50 types of objects in the standard Object List



**Radio Button**





### Tri-State Switch



### Slider Switch



### Dynamic Bitmap



### Bitmap Text

Use any Font on Your PC

### Set Language



## Hundreds of pre-configured parts

C-more also provides ready-made "parts" (versions of each default object) that are available to drag and drop into your project. Select any object to see preconfigured parts in the Parts List. Select the one that most closely matches your needs - and customize it even further, if you like. Then save it in the user library for future use.

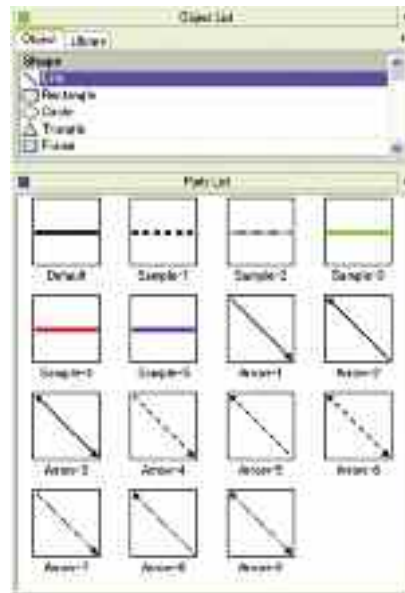

## Create custom objects

Use a combination of C-more objects and parts to create your own objects, or even entire sections of screens.

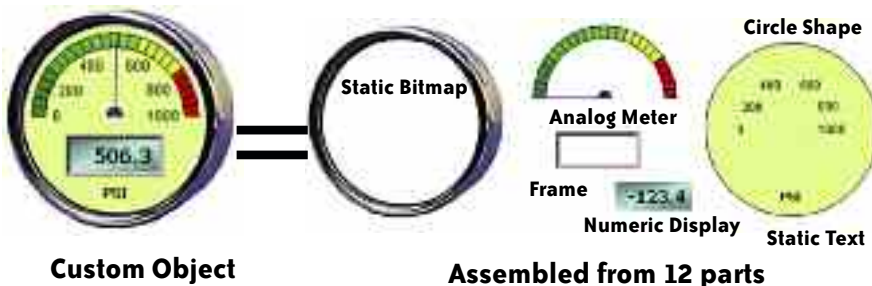

## Download our free demo software



and check out all the objects for yourself. See how easy it is to create your own custom objects.

Go to [www.c-morehmi.com/software/software\\_demo.html](http://www.c-morehmi.com/software/software_demo.html)

# Powerful Alarm and Event Features

## Fill-in-the-blank Event Manager saves time, PLC/PAC programming and memory









**C-more** provides a powerful yet easy-to-use Event Manager which takes exception handling (including alarms) and scheduling to the next level. The simple fill-in-the-blank manager allows events to automatically trigger several actions without the need for hours of PLC/PAC programming.

**A**  
CHOOSE  
EVENT



On the Event Manager screen, create an event, enter the required data, and select as many actions as you desire. It's that easy!

**B**  
SELECT  
ACTIONS

-  Log an alarm
-  Change screen
-  FTP
-  Play a sound
-  Send email (with embedded tag data)
-  Write values to tags
-  Screen capture
-  Copy tag values
-  Pop up a message box (with embedded tag data)



**C**  
FILL  
IN THE  
BLANKS

**D**  
CLICK  
APPLY



“No thanks, I just want the old style...”

Remember the old single-line alarm messages across the bottom of the screen, and the preconfigured screen for viewing alarm history and frequency? Yes, **C-more** does that too, along with alarm history reports.



# Convenient Recipe Database Functions

## More flexible recipes save time

**C-more** provides tremendous flexibility and capacity to applications that require multiple recipes. It has a simple recipe button that supports 99 recipe sheets, each with 1000 recipes of 255 values each. **C-more** recipe values can be modified and saved on the fly by the operator while the machine is running.

## User can configure a pop-up screen to scroll through and call up to 1000 recipes

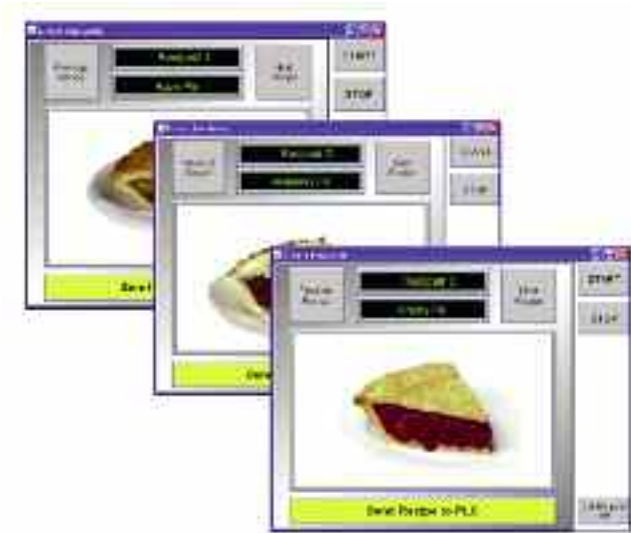

You can even build a pop-up window that uses several other **C-more** objects to create a powerful, graphic oriented recipe object to scroll through all recipes in a sheet, giving the operator a very simple means to select, change and load recipes.

## Spreadsheet-based Recipe Creation

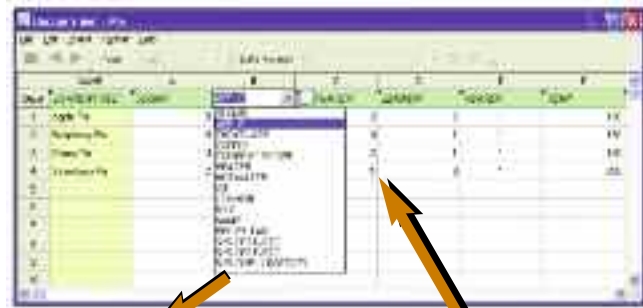

Select tags with one click

Insert constant values or select a tag

- New Recipe Database
- 99 source recipe sheets
- 1000 recipes per recipe sheet
- 255 possible values per recipe sheet
- Operator editing of recipes while running

## Operators can view, edit and load recipes with a touch of the screen

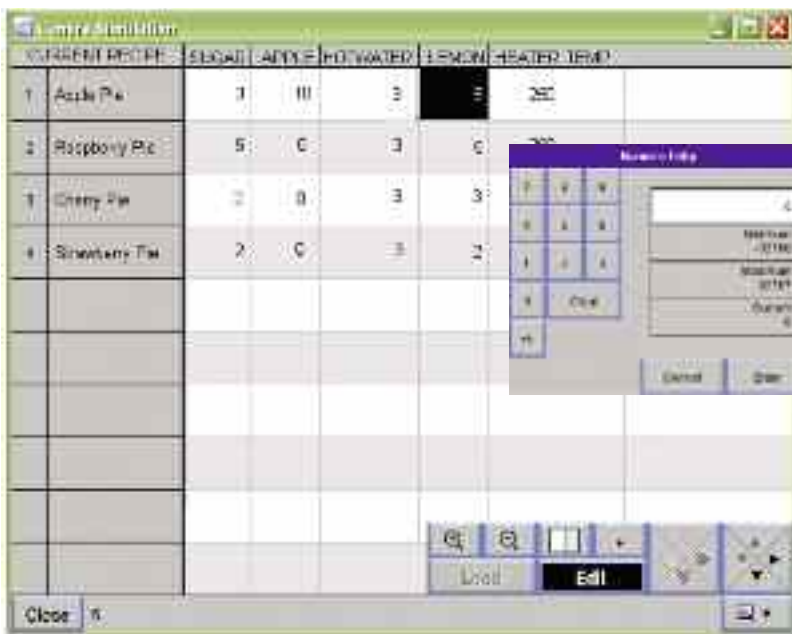

• Operators can select the recipe to edit right from the panel

• Click a cell and then enter the value with a keypad

• Select the "Load" button and the values are written to the PLC Tags

• New toolbar allows operator editing of recipes while running

*Note: Multiple Recipe Features available when using version 1.30 or later for both the C-more programming Software and panel firmware.*







# User Libraries, and Project Migration

## User libraries allow you to re-use your work again and again

C-more provides three user libraries that allow you to efficiently re-use your work throughout your project or for other projects in the future. You can store a custom object, such as your company logo or a group of objects that comprise a custom object (see the tank with cut-away and bar

graph below). You can also store entire screens, graphics and sound bites. You can access your libraries at any time and re-use your work by merely clicking on the saved item and dragging it from the library into your project. You can even import and export library items to share with other designers.

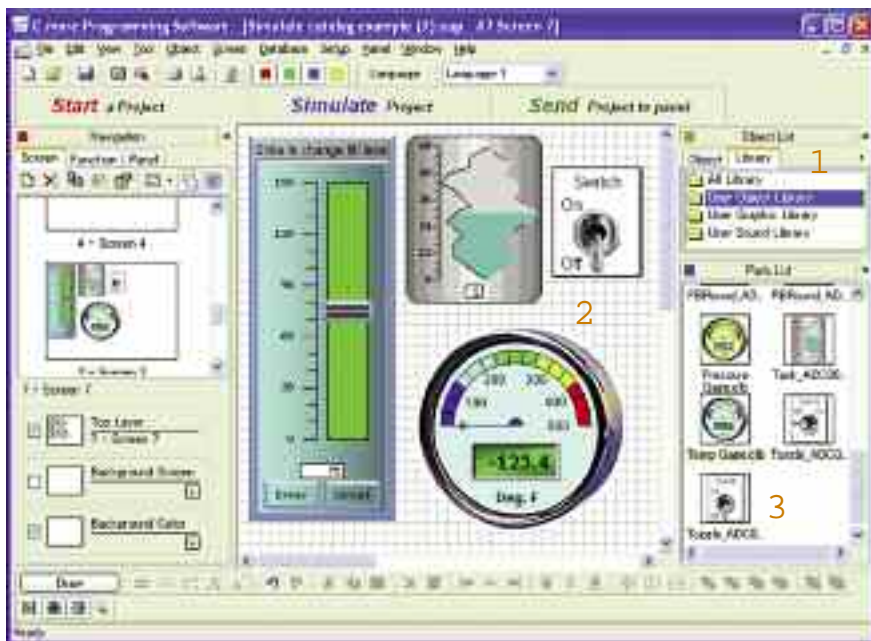

1 Object, graphic and sound libraries

2 Create, store and retrieve your:  
• Custom objects  
• Entire screens  
• Sound bites

3 Re-use your work on this project or future projects



Check out our online library at: [www.c-morehmi.com/support\\_tools/library.html](http://www.c-morehmi.com/support_tools/library.html)

## Change your project screen size with a click of your mouse

Imagine developing your project on a 10-inch panel and then deciding to change the size to a 15-inch panel or an 8-inch panel. In the past, you most likely had to recreate your entire project and reconfigure every object, tag and screen.

a different size display with a click of the mouse. Of course, you may wish to move things around a little since you have a different screen size. This feature is great for OEMs or integrators that may be installing different configurations of the same machine or process.

With C-more, your project can be automatically converted for

