

BRYANT® Wire Management Products

Cord Grips Family Overview

Strain Relief Grips

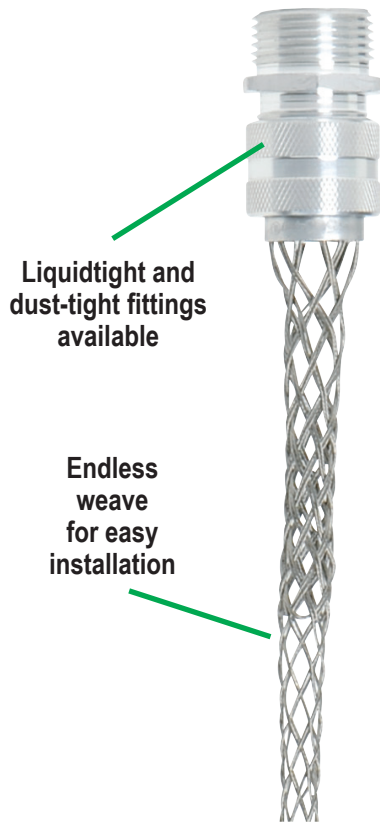

Strain Relief Grips are used to connect cable enclosures and industrial equipment. These grips prevent cable pullout at the point of termination due to tension, vibration, flexure or motion. Used in conjunction with bus drop support grips and safety springs, they are an integral part of an overall support and strain relief system. These grips are suitable for indoor or outdoor use where subject to moisture, splash or washdown. Examples are crane hoist and pendant drop stations, hand tools, pumps, and processing equipment.

Deluxe Cord Strain Relief Grips

- Endless weave for easy installation
- Indoor and outdoor applications
- Provides arc-of-bend control
- Stainless steel mesh
- Corrosion resistant
- Liquid-tight and dust-tight
- Range 0.187 – 1.687 inches

Dust-tight Strain Relief Grips

- Dust-tight
- Galvanized steel mesh
- For indoor applications only
- Ideal for use in bus drop systems, motor connections, panel boards, and internal wiring of machines
- Range 0.32 – 1.70 inches

Support Grips

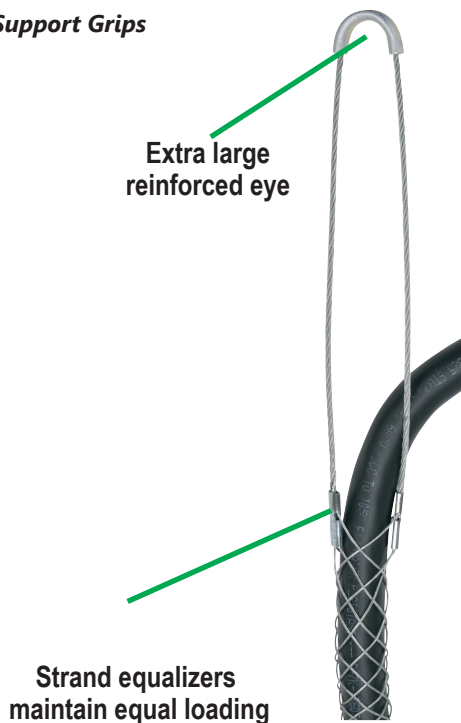

Support Grips are applied to the vertical or horizontal runs of cable or service lines to support dead weight and reduce potential damage due to breakage or stress. These grips are designed to be used indoors for cable support where flexible cable connects electrical equipment to bus duct. Applications also include support for air hoses and water hoses.

Standard Duty Support Grips

- Single U eye closed mesh fits over cable end
- Indoor and outdoor applications
- Split mesh is used when cable end is inaccessible
- Strand equalizers reinforce gripping strength and position; distributes load equally
- Range 0.54 – 1.74 inches

Bus Drop Support Grips

- Light duty
- Strand equalizers position wires for equal loading
- Single variable weave
- Indoor use only
- Range 0.24 – 1.25 inches

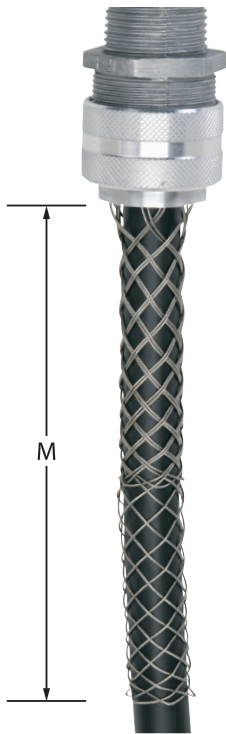

M = Mesh Length

Features

- Double to single weave variable mesh
- Stainless steel mesh offers corrosion resistance and adds strength
- Neoprene oil and watertight seal
- Liquidtight and dust-tight seal
- Aluminum fitting
- Mesh flexibility for easy installation
- Lock nuts and bushing not included

Applications

- Food processing equipment
- Chemical machinery
- Switch boxes
- Pumps
- Compressors
- Motors & machine tool shops
- Drop stations
- Heavy-duty applications
- Indoor/outdoor applications

Agency Approvals

- UL Listed File E167220
- Type 1, 4, 4X, 6, 6P, 3, 3X, 3S, 3SX, 5, 12K or 13
- CSA Certified File LR701228

Bryant® Deluxe Strain Relief Cord Grips, Straight Male Thread						
Part Number	Price	Drawing Link	Grip Diameter Range Inches (cm.)	Trade Size NPT*	Mesh Length Inches (cm.)	Weight (lbs.)
DC1812		PDF	0.187-0.250 (0.47-0.63)	½ inch	2.44 (6.20)	0.1
DC2512		PDF	0.250-0.375 (0.63-0.95)	½ inch	3.91 (9.93)	0.1
DC3712		PDF	0.375-0.500 (0.95-1.27)	½ inch	4.44 (11.28)	0.1
DC5012		PDF	0.500-0.625 (1.27-1.59)	½ inch	4.71 (11.96)	0.1
DC5034		PDF	0.500-0.625 (1.27-1.59)	¾ inch	4.71 (11.96)	0.1
DC6234		PDF	0.625-0.750 (1.59-1.90)	¾ inch	6.31 (16.03)	0.1
DC621		PDF	0.625-0.750 (1.59-1.90)	1 inch	6.11 (15.52)	0.1
DC751		PDF	0.750-0.875 (1.90-2.22)	1 inch	6.31 (16.03)	0.3
DC871		PDF	0.875-1.000 (2.22-2.54)	1 inch	6.51 (16.54)	0.3
DC100114		PDF	1.000-1.125 (2.54-2.86)	1¼ inch	6.16 (15.65)	0.5
DC112114		PDF	1.125-1.250 (2.86-3.17)	1¼ inch	6.04 (15.34)	0.5
DC125112		PDF	1.250-1.375 (3.17-3.49)	1½ inch	7.66 (19.46)	0.6
DC131112		PDF	1.312-1.437 (3.33-3.65)	1½ inch	8.11 (20.60)	1.0
DC1562		PDF	1.562-1.687 (3.97-4.28)	2 inch	10.00 (25.40)	1.0

Note: NPT = National Pipe Taper

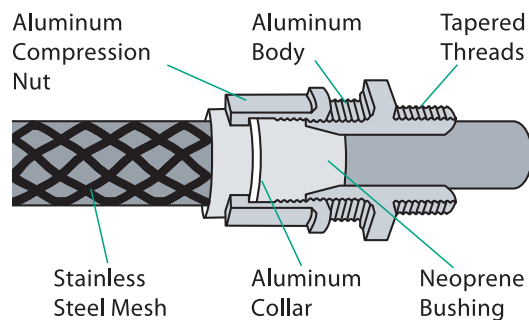

Dust-tight Strain Relief Grips - Wide Range

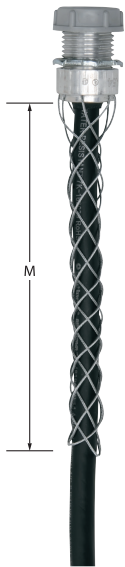

M = Mesh Length

Features

- Single weave variable mesh
- Galvanized steel mesh for additional holding power in abrasive environments
- Insulating bushing
- One-piece design
- Dust-tight seal
- Easily installed
- Steel locknut and threaded fitting
- Lock nuts and bushing included

Applications

- Bus drop systems
- Motor boxes
- Power boxes
- Internal wiring of machines and cabinets
- Light to moderate duty applications
- Indoor use only
- Controlling arc-of-bend

Agency Approvals

- UL Listed File E167220
- Type 1, 3, 3X, 3S, 3SX, 5, 12K or 13
- CSA Certified File LR701228

Bryant® Wide Range Strain Relief Grips							
Part Number	Price	Drawing Link	Cable Diameter Range Inches (cm)	Trade Size NPS/NPT*	Mesh Length Inches (cm)	Knockout Hole Recommended Min. to Max. Inches (mm)	Weight (lbs.)
BDSR32		PDF	0.32-0.43 (0.81-1.09)	½" NPS	3.75 (9.52)	0.86-0.91 (21.8-23.0)	0.1
BDSR43		PDF	0.43-0.54 (1.09-1.37)	½" NPS	4.75 (12.06)	0.86-0.91 (21.8-23.0)	0.1
BDSR54		PDF	0.54-0.73 (1.37-1.85)	¾" NPS	6.50 (16.51)	1.09-1.14 (27.8-29.0)	0.1
BDSR73		PDF	0.73-0.97 (1.85-2.46)	1" NPS	7.00 (17.78)	1.36-1.41 (34.5-35.7)	0.2
BDSR97		PDF	0.97-1.25 (2.46-3.17)	1¼" NPS	9.00 (22.86)	1.72-1.77 (43.7-44.9)	0.3
BDSR125		PDF	1.25-1.50 (3.17-3.81)	1½" NPT	11.75 (29.84)	1.97-2.02 (50.0-51.2)	0.4
BDSR150		PDF	1.50-1.70 (3.81-4.32)	2" NPT	13.25 (33.65)	2.45-2.50 (62.3-63.5)	0.5

Note: NPS = National Pipe Straight
NPT = National Pipe Taper

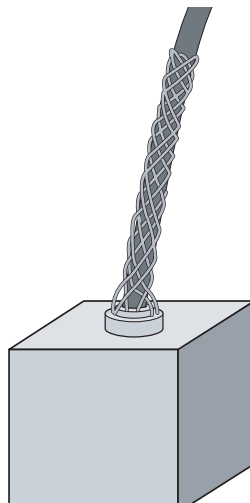

Technical Data

Working Load Factors for Wire Mesh Grips

There are many variables associated with the use of wire mesh cable grips. Working load is an estimation of several factors including tension, cable diameter, number of cables gripped, gripping surface and more. Safety factors associated in the product's use must be considered together with the effects of abrasion, corrosion, prior use and abuse and other variables specific to the application.

The appropriate breaking strength of a Bryant® cable grip represents an average calculation based on data established from actual testing performed in our engineering laboratories. Under

normal usage conditions, the recommended factor of safety is 5 for pulling grips and 10 for support grips.

Any warranty as to quality, performance of fitness-for-use of the grips is always premised on the condition that the published strengths apply only to new, unused grips, and that such products are properly stored, handled, used, maintained and inspected by the user at a frequency appropriate for the use and condition of the grip.

Example

Grip Style	Part Number	Approximate Breaking Strength	Safety Factor	Max. Recommended Load
Pulling	PA075	4000 lbs.	5	800 lbs.
Support	SPC150U	1610 lbs.	10	161 lbs.

Note: The maximum recommended working load is the greatest tension to be exerted on a grip for any application, with a margin of safety to protect against unforeseen and unusual circumstances.

Wire Mesh Grip Materials

Material	Features	Product Group
Galvanized steel wire	High strength	Pulling grips
	Not subject to continuous outside environment	Bus drop grips
		Strain relief grips
Tin-Coated bronze wire	Corrosion-resistant for normal outside areas Non-magnetic Moderate strength	Support grips
Stainless steel wire (302/304)	Corrosion resistant	Strain relief grips

Applicable Code Requirements:

Bryant Economy Cable Grips meet the following requirements

NEC® 300.19	Support of conductors in vertical raceways
NEC® 350	Liquidtight flexible metal conduit termination
NEC® 400.14	Flexible cord and cable protection
NEC® 400.10	Strain relief at joints and terminals

Operating Temperatures

Material	Temperature Range
Aluminum	-40°F to +300°F (-40°C to +149°C)
Aluminum Deluxe Cord Grips	-30°F to +240°F (-34°C to +115°C)

Flammability (Non-metallic deluxe cord Grips will not support combustion)

Component	Rating
Mesh Grip	UL 94HB
Fitting	UL 94V-2

Hazardous Locations

	Product Categories
The product categories listed on the right are suitable for use in hazardous locations per Class I Div. 2, Class II Div. 1 & 2, Class III Div. 1 & 2	Deluxe cord grip, aluminum fitting Dust-tight strain relief grips

Wet Locations

	Product Categories
The products noted to the right are suitable for use in wet locations when a listed sealing ring is used between box and fitting	Deluxe cord grip, aluminum fitting

Multiple Cable/Grip Selection Chart

Multiple Cable Selection Charts for Cables and Wires of Unequal Diameters

How to choose the correct grip size:

1. Find the grip circumference range by measuring the circumference of the bundle of different diameter cables to be gripped (see illustration).
2. Divide the bundle circumference by 3.14 to determine the diameter.
3. Choose a grip offering a range of cable diameters the same as the cable diameter.

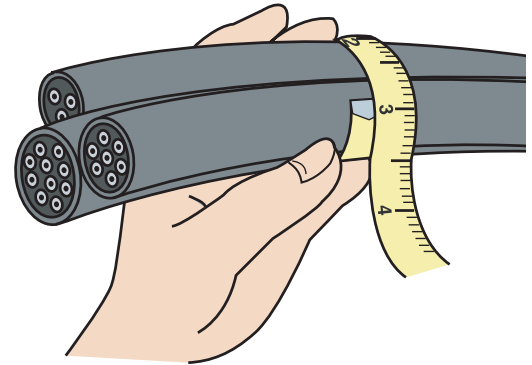

Selection Chart for Determining Grip Size for Multiple Equal Diameter Cables Held in a Single Grip

1. Under "Number of Cables in One Grip", find the diameter range of your cables in vertical column. Read Grip Size and Grip Diameter Range to the left.
2. If your diameter is the maximum of the range shown, stay with the same size grip.
3. Example: 3 cables, each with 0.89" (2.26 cm) diameter, select a 1.50"-1.74" (3.81 cm - 4.42 cm) range or 150 Grip Size.

Number of Cables in One Grip									
	Grip Size	Grip Dia. Range Inches (cm)	2	3	4	5	6 / 7	8	9
Pulling and Support	50	0.50-0.61 (1.27-1.55)	0.30-0.38 (0.76-0.97)	0.25-0.31 (0.63-0.79)	0.22-0.27 (0.56-0.69)	0.19-0.24 (0.48-0.61)	0.17-0.22 (0.43-0.56)	0.15-0.19 (0.38-0.48)	0.14-0.18 (0.36-0.46)
	62	0.62-0.74 (1.57-1.88)	0.38-0.44 (0.97-1.12)	0.31-0.36 (0.79-0.91)	0.27-0.31 (0.69-0.79)	0.24-0.29 (0.61-0.74)	0.22-0.26 (0.56-0.66)	0.19-0.23 (0.48-0.58)	0.18-0.21 (0.46-0.53)
	75	0.75-0.99 (1.90-2.51)	0.44-0.59 (1.12-1.50)	0.36-0.49 (0.91-1.24)	0.31-0.42 (0.79-1.07)	0.29-0.38 (0.74-0.97)	0.26-0.34 (0.66-0.86)	0.23-0.31 (0.58-0.79)	0.21-0.28 (0.53-0.71)
	100	1.00-1.24 (2.54-3.15)	0.59-0.75 (1.50-1.90)	0.49-0.63 (1.24-1.60)	0.42-0.54 (1.07-1.37)	0.38-0.48 (0.97-1.22)	0.34-0.43 (0.86-1.09)	0.31-0.39 (0.79-0.99)	0.28-0.35 (0.71-0.89)
	125	1.25-1.49 (3.17-3.78)	0.75-0.90 (1.90-2.29)	0.63-0.76 (1.60-1.93)	0.54-0.65 (1.37-1.65)	0.48-0.58 (1.22-1.47)	0.43-0.52 (1.09-1.32)	0.39-0.46 (0.99-1.17)	0.35-0.42 (0.89-1.07)
	150	1.50-1.74 (3.81-4.42)	0.90-1.07 (2.29-2.72)	0.76-0.89 (1.93-2.26)	0.65-0.77 (1.65-1.96)	0.58-0.67 (1.47-1.70)	0.52-0.60 (1.32-1.52)	0.46-0.54 (1.17-1.37)	0.42-0.49 (1.07-1.24)
	175	1.75-1.99 (4.44-5.05)	1.07-1.22 (2.72-3.10)	0.89-1.02 (2.26-2.59)	0.77-0.88 (1.96-2.24)	0.67-0.77 (1.70-1.96)	0.60-0.69 (1.52-1.75)	0.54-0.62 (1.37-1.57)	0.49-0.56 (1.24-1.42)
	200	2.00-2.49 (5.08-6.32)	1.22-1.53 (3.10-3.89)	1.02-1.28 (2.59-3.25)	0.88-1.10 (2.24-2.79)	0.77-0.96 (1.96-2.44)	0.69-0.86 (1.75-2.18)	0.62-0.77 (1.57-1.96)	0.56-0.71 (1.42-1.80)
	250	2.50-2.99 (6.35-7.59)	1.53-1.83 (3.89-4.65)	1.28-1.53 (3.25-3.89)	1.10-1.32 (2.79-3.35)	0.96-1.16 (2.44-2.95)	0.86-1.03 (2.18-2.62)	0.77-0.93 (1.96-2.36)	0.71-0.85 (1.80-2.16)
	300	3.00-3.49 (7.62-8.86)	1.83-2.14 (4.65-5.44)	1.53-1.79 (3.89-4.55)	1.32-1.54 (3.35-3.91)	1.16-1.35 (2.95-3.43)	1.03-1.20 (2.62-3.05)	0.93-1.08 (2.36-2.74)	0.85-0.99 (2.16-2.51)
	350	3.50-3.99 (8.89-10.13)	2.14-2.44 (5.44-6.20)	1.79-2.05 (4.55-5.21)	1.54-1.76 (3.91-4.47)	1.35-1.54 (3.43-3.91)	1.20-1.37 (3.05-3.48)	1.08-1.24 (2.74-3.15)	0.99-1.13 (2.51-2.87)
	400	4.00-4.49 (10.16-11.40)	2.44-2.75 (6.20-6.98)	2.05-2.30 (5.21-5.84)	1.76-1.98 (4.47-5.03)	1.54-1.74 (3.91-4.42)	1.37-1.55 (3.48-3.94)	1.24-1.39 (3.15-3.53)	1.13-1.27 (2.87-3.23)
450	4.50-4.99 (11.43-12.67)	2.75-3.06 (6.98-7.77)	2.30-2.56 (5.84-6.50)	1.98-2.20 (5.03-5.59)	1.74-1.93 (4.42-4.90)	1.55-1.72 (3.94-4.37)	1.39-1.55 (3.53-3.94)	1.27-1.41 (3.23-3.58)	