

DC Output Modules

D4-32TD1 DC Output	
Outputs per Module	32 (current sinking)
Commons per Module	4 (isolated)
Operating Voltage	4.75–26.4 VDC
Output Type	NPN Open Collector
Peak Voltage	36VDC
ON Voltage Drop	0.6 VDC @ 0.2 A
Max Current (resistive)	0.2 A/point 1.6 A/common
Max Leakage Current	0.1mA @ 36VDC
Max Inrush Current	1A for 10ms 0.5A for 100ms
Minimum Load	0.1 mA
Base Power Required 5V	250mA max
External DC Required	24VDC± 10%, 140mA max
OFF to ON Response	0.1 ms
ON to OFF Response	0.1 ms
Terminal Type (See ZIPLinks note below)	Connectors sold separately.
Status Indicators	Logic side
Weight	6.7 oz. (190g)
Fuses	None

Only 16 status points can be displayed at one time on the front of the module.
In the A - B position the status of the first group of 16 output points (A0-A7, B0-B7) is displayed. In the C - D position the status of the second group of 16 output points (C0-C7, D0-D7) is displayed.

D4-32TD2 DC Output	
Outputs per Module	32 (current sourcing)
Commons per Module	4 (isolated)
Operating Voltage	10.8–26.4 VDC
Output Type	PNP Open Collector
Peak Voltage	30VDC
ON Voltage Drop	0.6 VDC @ 0.2 A
Max Current (resistive)	0.2 A/point 1.0 A/common 4.0 A/module
Max Leakage Current	0.01 mA @ 26.4VDC
Max Inrush Current	500mA for 10ms
Minimum Load	0.2 mA
Base Power Required 5V	350mA max
External DC Required	10.8–26.4VDC 1A/common including load
OFF to ON Response	0.2 ms
ON to OFF Response	0.2 ms
Terminal Type (See ZIPLinks note below)	Connectors sold separately.
Status Indicators	Logic side
Weight	6.7 oz. (190g)
Fuses	None

Only 16 status points can be displayed at one time on the front of the module.
In the A - B position, the status of the first group of 16 output points (A0-A7, B0-B7) is displayed. In the C - D position, the status of the second group of 16 output points (C0-C7, D0-D7) is displayed.

See Wiring Solutions for part numbers of ZIPLink cables and connection modules compatible with this I/O module.



See Wiring Solutions for part numbers of ZIPLink cables and connection modules compatible with this I/O module.



Note: When used with the ZIPLink wiring system, relay outputs are derated not to exceed 2 Amps per point max.

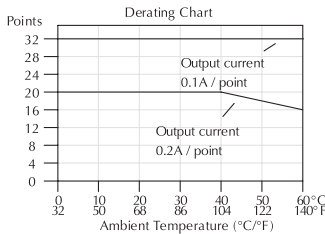

5-24VDC		OUTPUT	
A/C	B/D	A-B	C-D
0	4	0	4
1	5	1	5
2	6	2	6
3	7	3	7

D4-32TD1

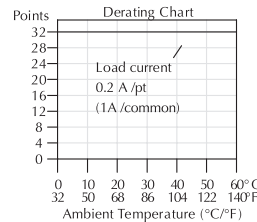
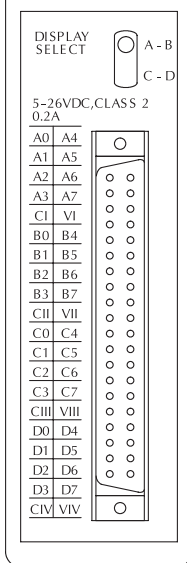

12-24VDC		OUTPUT	
A/C	B/D	A-B	C-D
0	4	0	4
1	5	1	5
2	6	2	6
3	7	3	7

D4-32TD2

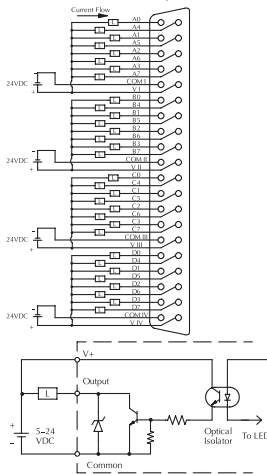
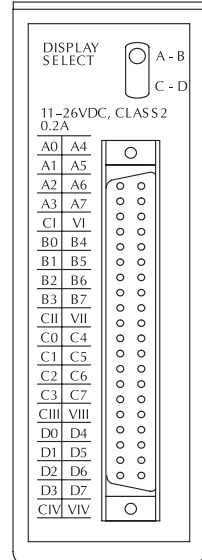

This circuit shows 24VDC used for the module and load. If load voltages less than 24VDC are required, you must use separate supplies.

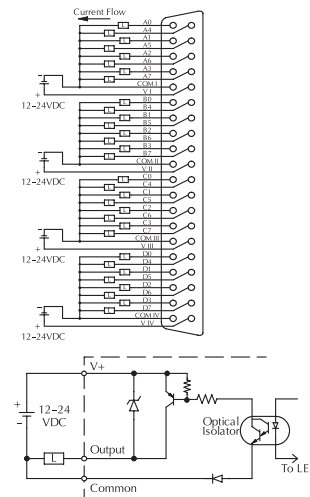

Check the Power Budget

Verify your power budget requirements

Your I/O configuration choice can be affected by the power requirements of the I/O modules you choose. When determining the types and quantity of I/O modules you will be using, it is important to remember there is a limited amount of power available from the power supply.

The chart on the opposite page indicates the power supplied and used by each DL405 device. The adjacent chart shows an example of how to calculate the power used by your particular system. These two charts should make it easy for you to determine if the devices you have chosen fit within the power budget of your system configuration.

If the I/O you have chosen exceeds the maximum power available from the power supply, you can resolve the problem by shifting some of the modules to an expansion base or remote I/O base (if you are using remote I/O).

Warning: It is extremely important to calculate the power budget correctly. If you exceed the power budget, the system may operate in an unpredictable manner which may result in a risk of personal injury or equipment damage.

Use ZIPLinks to reduce power requirements

If your application requires a lot of relay outputs, consider using the ZIPLink AC or DC relay output modules. These modules can switch high current (10A) loads without putting a load on your base power budget. Refer to Wiring System for DL405 PLCs later in this section for more information.

This logo is placed next to I/O modules that are supported by the ZIPLink connection systems.

See the I/O module specifications at the end of this section.



Calculating your power usage

The following example shows how to calculate the power budget for the DL405 system. The example is constructed around a single 8-slot base using the devices shown. It is recommended you construct a similar table for each base in your system.

A			
<i>Base Number</i>	<i>Device Type</i>	<i>5 VDC (mA)</i>	<i>External 24 VDC Power (mA)</i>
0			
B CURRENT SUPPLIED			
<i>CPU/Expansion Unit /Remote Slave</i>	D4-454 CPU	3700	400
C CURRENT REQUIRED			
<i>SLOT 0</i>	D4-16ND2	+150	+0
<i>SLOT 1</i>	D4-16ND2	+150	+0
<i>SLOT 2</i>	F4-04DA	+120	+100
<i>SLOT 3</i>	D4-08NA	+100	+0
<i>SLOT 4</i>	D4-08NA	+100	+0
<i>SLOT 5</i>	D4-16TD2	+100	+0
<i>SLOT 6</i>	D4-16TD2	+100	+0
<i>SLOT 7</i>	D4-16TR	+1000	+0
D OTHER			
<i>BASE</i>	D4-08B-1	+80	+0
<i>Handheld Programmer</i>	D4-HPP-1	+320	+0
E Maximum Current Required		2820	100
F Remaining Current Available		3700-2820=880	400-100=300
1. Using a chart similar to the one above, fill in column 2. 2. Using the tables on the opposite page, enter the current supplied and used by each device (columns 3 and 4). Pay special attention to the current supplied by the CPU, Expansion Unit, and Remote Slave since they differ. Devices which fall into the "Other" category (Row D) are devices such as the Base and the Handheld programmer, which also have power requirements, but do not plug directly into the base. 3. Add the current used by the system devices (columns 3 and 4) starting with Slot 0 and put the total in the row labeled "maximum current required" (Row E). 4. Subtract the row labeled "Maximum current required" (Row E), from the row labeled "Current Supplied" (Row B). Place the difference in the row labeled "Remaining Current Available" (Row F). 5. If "Maximum Current Required" is greater than "Current Supplied" in either column 3 or 4, the power budget will be exceeded. It will be unsafe to use this configuration and you will need to restructure your I/O configuration. Note the auxiliary 24VDC power supply does not need to supply all the external power. If you need more than the 400mA supplied, you can add an external 24VDC power supply. This will help keep you within your power budget for external power.			

DL405 CPU power supply specifications and power requirements

Specification	AC Powered Units	24 VDC Powered Units
Part Numbers	D4-454, D4-EX (expansion base unit), D4-RS (remote slave unit)	D4-454DC-1, D4-EXDC (expansion base unit)
Voltage Withstand (dielectric)	1 minute @ 1,500 VAC between primary, secondary, field ground, and run relay	
Insulation Resistance	> 10MΩ at 500VDC	
Input Voltage Range	85-132 VAC (110V range) 170-264 VAC (220V range)	20-28 VDC (24VDC) with less than 10% ripple
Maximum Inrush Current	20A	20A
Maximum Power	50VA	38W

Power Requirements

Power Supplied					
<i>CPUs/Remote Units/ Expansion Units</i>	<i>5 VDC Current Supplied in mA</i>	<i>24V Aux Power Supplied in mA</i>	<i>CPUs/Remote Units/ Expansion Units</i>	<i>5V Current Supplied in mA</i>	<i>24V Aux Power Supplied in mA</i>
D4-454 CPU D4-454DC-1	3100 3100	400 NONE	D4-EX D4-EXDC D4-RS H4-EBC	4000 4000 3700 3470	400 NONE 400 400
Power Consumed					
<i>Power-consuming Device</i>	<i>5V Current Consumed</i>	<i>External 24VDC Current Required</i>	<i>Power-consuming Device</i>	<i>5V Current Consumed</i>	<i>External 24VDC Current Required</i>
<i>I/O Bases</i>			<i>Analog Modules (continued)</i>		
D4-04B-1 D4-06B-1 D4-08B-1	80 80 80	NONE NONE NONE	F4-16AD-1 F4-16AD-2 F4-04DA-1 F4-04DA-2 F4-04DAS-1 F4-08DA-1 F4-08DA-2 F4-16DA-1 F4-16DA-2 F4-08RTD F4-08THM-n F4-08THM	75 75 70 90 60 90 80 90 80 80 120 110	100 100 75+20 per circuit 90 60 per circuit 100+20 per circuit 150 100+20 per circuit 25 max. NONE 50 60
<i>DC Input Modules</i>			<i>Remote I/O</i>		
D4-16ND2 D4-16ND2F D4-32ND3-1 D4-64ND2	150 150 150 300 max.	NONE NONE NONE NONE	H4-ERM100 H4-ERM-F D4-RM	320(300) 450 300	NONE NONE NONE
<i>AC Input Modules</i>			<i>Communications and Networking</i>		
D4-08NA D4-16NA	100 150	NONE NONE	H4-ECOM100 D4-DCM F4-MAS-MB	300 500 235	NONE NONE NONE
<i>AC/DC Input Modules</i>			<i>CoProcessors</i>		
D4-16NE3	150	NONE	F4-CP128-1	305	NONE
<i>DC Output Modules</i>			<i>Specialty Modules</i>		
D4-16TD1 D4-16TD2 D4-32TD1 D4-32TD2 D4-64TD1	200 400 250 350 800	125 NONE 140 120 (4A max including loads) NONE	H4-CTRIO D4-16SIM F4-4LTC	400 150 280	NONE NONE 75
<i>AC Output Modules</i>			<i>Programming</i>		
D4-08TA D4-16TA	250 450	NONE NONE	D4-HPP-1 (Handheld Prog.)	320	NONE
<i>Relay Output Modules</i>			<i>Operator Interface</i>		
D4-08TR F4-08TRS-1 F4-08TRS-2 D4-16TR	550 575 575 1000	NONE NONE NONE NONE	DV-1000	150	NONE
<i>Analog Modules</i>			C-more Micro-Graphic	210	NONE
F4-04AD F4-04ADS F4-08AD	150 370 75	100 120 90			

Wiring Solutions using the ZIPLink Wiring System

ZIPLinks eliminate the normally tedious process of wiring between devices by utilizing prewired cables and DIN rail mount connector modules. It's as simple as plugging in a cable connector at either end or terminating wires at only one end. Prewired cables keep installation clean and efficient, using half the space at a fraction of the cost of standard terminal blocks. There are several wiring

solutions available when using the ZIPLink System ranging from PLC I/O-to-ZIPLink Connector Modules that are ready for field termination, options for connecting to third party devices, GS, DuraPulse and SureServo Drives, and specialty relay, transorb and communications modules. Pre-printed I/O-specific adhesive label strips for quick marking of ZIPLink modules are provided with ZIPLink cables. See the following solutions to help determine the best ZIPLink system for your application.

Solution 1: DirectLOGIC I/O Modules to ZIPLink Connector Modules

When looking for quick and easy I/O-to-field termination, a ZIPLink connector module used in conjunction with a prewired ZIPLink cable, consisting of an I/O terminal block at one end and a multi-pin connector at the other end, is the best solution.

Using the PLC I/O Modules to ZIPLink Connector Modules selector tables located in this section,

1. Locate your I/O module/PLC.
2. Select a ZIPLink Module.
3. Select a corresponding ZIPLink Cable.



Solution 2: DirectLOGIC I/O Modules to 3rd Party Devices

When wanting to connect I/O to another device within close proximity of the I/O modules, no extra terminal blocks are necessary when using the ZIPLink Pigtail Cables. ZIPLink Pigtail Cables are prewired to an I/O terminal block with color-coded pigtail with soldered-tip wires on the other end.

Using the I/O Modules to 3rd Party Devices selector tables located in this section,

1. Locate your PLC I/O module.
2. Select a ZIPLink Pigtail Cable that is compatible with your 3rd party device.



Solution 3: GS Series and DuraPulse Drives Communication Cables

Need to communicate via Modbus RTU to a drive or a network of drives?

ZIPLink cables are available in a wide range of configurations for connecting to PLCs and SureServo, SureStep, Stellar Soft Starter and AC drives. Add a ZIPLink communications module to quickly and easily set up a multi-device network.

Using the Drives Communication selector tables located in this section,

1. Locate your Drive and type of communications.
2. Select a ZIPLink cable and other associated hardware.



Solution 4: Serial Communications Cables

ZIPLink offers communications cables for use with *DirectLOGIC*, CLICK, and Productivity3000 CPUs, that can also be used with other communications devices. Connections include a 6-pin RJ12 or 9-pin, 15-pin and 25-pin D-sub connectors which can be used in conjunction with the RJ12 or D-Sub Feedthrough modules.

Using the Serial Communications Cables selector table located in this section,

1. Locate your connector type
2. Select a cable.



Solution 5: Specialty ZIPLink Modules

For additional application solutions, ZIPLink modules are available in a variety of configurations including stand-alone relays, 24VDC and 120VAC transorb modules, D-sub, RJ12 and RJ45 feedthrough modules, communication port adapter and distribution modules, and *SureServo* 50-pin I/O interface connection.

Using the ZIPLink Specialty Modules selector table located in this section,

1. Locate the type of application.
2. Select a ZIPLink module.

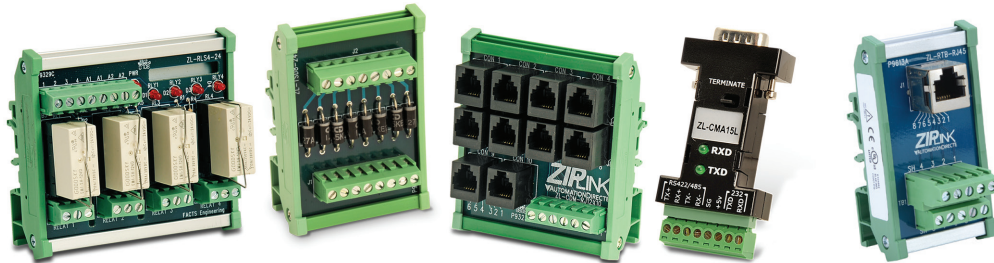

Solution 6: ZIPLink Connector Modules to 3rd Party Devices

If you need a way to connect your device to terminal blocks without all that wiring time, then our pigtail cables with color-coded soldered-tip wires are a good solution. Used in conjunction with any compatible ZIPLink Connector Modules, a pigtail cable keeps wiring clean and easy and reduces troubleshooting time.

Using the Universal Connector Modules and Pigtail Cables table located in this section,

1. Select module type.
2. Select the number of pins.
3. Select cable.



PLC I/O Modules to ZIPLink Connector Modules - DL405

DL405 PLC Input Module ZIPLink Selector				
PLC	ZIPLink			
Input Module	# of Terms	Component	Module Part No.	Cable Part No.
D4-16ND2	20	See Note 3		
D4-16ND2F				
D4-32ND3-1 ²	40	Feedthrough	ZL-RTB40 (-1)	straight conn: ZL-D24-CBL40 ZL-D24-CBL40-1 ZL-D24-CBL40-2
D4-32ND3-2 ²		Sensor	ZL-LTB32-24-1	
D4-64ND2 ^{1,2}		Feedthrough	ZL-RTB40 (-1)	45 deg conn: ZL-D24-CBL40-X ZL-D24-CBL40-1X ZL-D24-CBL40-2X
		Sensor	ZL-LTB32-24-1	
D4-08NA	11	See Note 3		
D4-16NA	20	See Note 3		
D4-16NA-1				
D4-16NE3				

DL405 PLC Output Module ZIPLink Selector				
PLC	ZIPLink			
Output Module	# of Terms	Component	Module Part No.	Cable Part No.
D4-08TD1	11	See Note 3		
D4-16TD1	20	See Note 3		
D4-16TD2				
D4-32TD1 ²	40	Feedthrough	Feedthrough ZL-RTB40 (-1)	straight conn: ZL-D24-CBL40 ZL-D24-CBL40-1 ZL-D24-CBL40-2
D4-32TD2 ²		Fuse		
D4-64TD1 ^{1,2}		Feedthrough	Fused ⁴ ZL-RFU40	45 deg conn: ZL-D24-CBL40-X ZL-D24-CBL40-1X ZL-D24-CBL40-2X
		Fuse		
D4-08TA	11	See Note 3		
D4-16TA	20	See Note 3		
D4-08TR	11	See Note 3		
F4-08TRS-1	20	See Note 3		
F4-08TRS-2				
D4-16TR		See Note 3		

DL405 PLC Analog Module ZIPLink Selector				
PLC	ZIPLink			
Analog Module	# of Terms	Component	Module	Cable
F4-04AD	20	See Note 3		
F4-04ADS				
F4-08AD				
F4-16AD-1				
F4-16AD-2				
F4-04DA-1				
F4-04DA-2				
F4-08DA-1				
F4-16DA-1				
F4-08DA-2				
F4-16DA-2				
F4-04DAS-1				
F4-08THM		T/C Wire Only		
F4-08THM-n				
F4-08RTD	Matched Only			

Tables Footnotes:

- ¹ The D4-64ND2 and D4-64TD1 modules have two 32-point connectors and require two ZIPLink cables and two ZIPLink connector modules.
- ² To make a custom cable for the 32 or 64-point modules, use: Ribbon-style Connector ZL-D24-CON-R, Solder-style 180° connector ZL-D24-CON or Solder-style 45° connector ZL-D24-CON-X
- ³ These modules are not supported by the ZIPLink wiring system.
- ⁴ Note: Fuses (5 x 20 mm) are not included. See Edison Electronic Fuse section for (5 x 20 mm) fuse. S500 and GMA electronic circuit protection for fast-acting maximum protection. S506 and GMC electronic circuit protection for time-delay performance. Ideal for inductive circuits. To ensure proper operation, do not exceed the voltage and current rating of ZIPLink module. ZL-RFU20 = 2A per circuit; ZL-RFU40 = 400 mA per circuit.



NOTE: ZIPLINK CONNECTOR MODULE SPECIFICATIONS FOLLOW THE COMPATIBILITY MATRIX TABLES IN THE ZIPLINK SECTION.