

DL105 I/O Specifications

F1-130AD



Wiring diagram and specifications

Power requirements

Voltage range94-240 VAC (30 VA)
100-240 VDC (30 W)

AC input specifications

Number of input points10
 Number of commons3 (isolated)
 Input voltage range80-132 VAC
90-150 VDC
 Input current6 mA @ 132 VAC
6 mA @ 150 VDC
 ON current/voltage level> 4 mA / 80 VAC
> 4 mA / 90 VDC
 OFF current/voltage level< 2 mA / 45 VAC
< 2 mA / 60 VDC
 OFF to ON response< 8 ms
 ON to OFF response< 15 ms
 FusesNone

DC output specifications

Number of output points8 (sinking)
 Number of commons3 (internally connected)
 Output circuitryMOSFET
 Output voltage range5-30 VDC
 Peak voltage60 VDC
 ON voltage drop0.45 VDC @ 0.5 A
 Maximum current0.5 A/point (Y0-Y1)
1.0 A/point (Y2-Y7)
 Maximum leakage current15 µA at 30 VDC
 Maximum inrush current1.5 A for 10 ms (Y0-Y1)
3 A for 10 ms (Y2-Y7)
 Minimum loadNone
 OFF to ON responseY0-Y1: 10 µs
Y2-Y7: 3.5 µs
 ON to OFF responseY0-Y1: 70 µs
Y2-Y7: 110 µs
 External DC power required10-30 VDC
@ 30 mA + load current
 FusesNone (external recommended)

Auxiliary 24 VDC Output

Voltage range21.6 - 26.4 VDC
 Output500 mA max., isolated
 Rippleless than 200 mV p - p

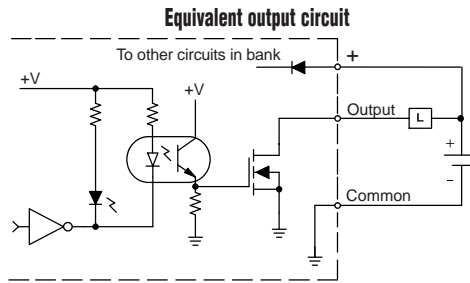
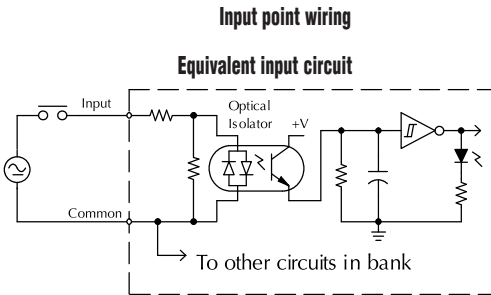
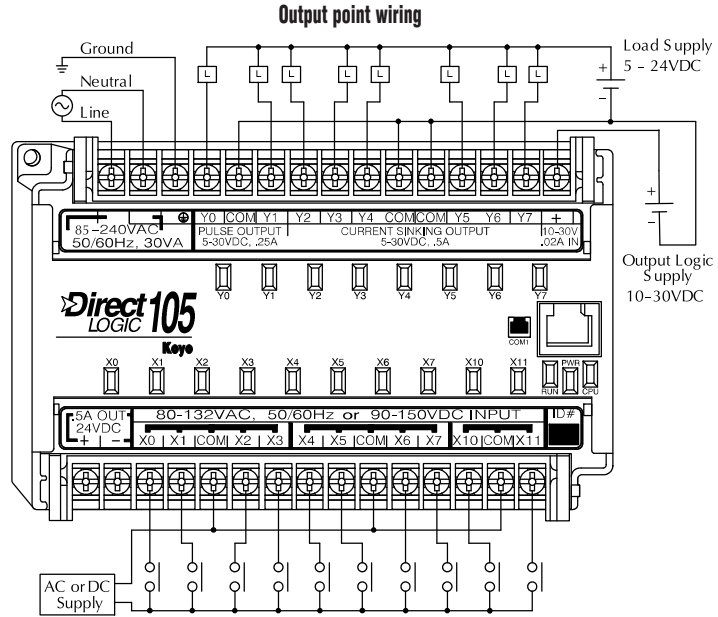

Derating chart for AC inputs

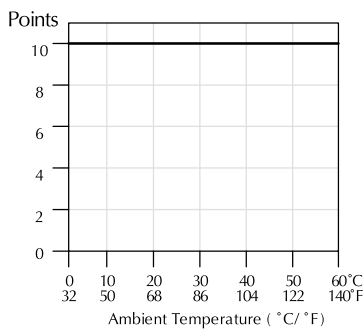

Derating chart for DC outputs

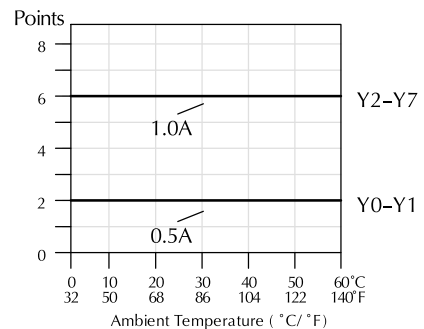

Features and Specifications

The DL105 micro PLCs contain the CPU, power supply and I/O all in the same housing. If you examine the CPU Specifications table, you'll see that we included many features found in our modular CPUs.

Review the specs

Make sure these features can satisfy the requirements of your application. Since these units are completely self-contained, you cannot expand the system or replace the CPU as you would in a modular system.

System capacity

System capacity is the ability to accommodate a variety of applications. For ladder memory, most Boolean instructions require one word. Some other instructions, such as timers, counters, etc., require two or more words. Our V-memory words are useful for data storage, etc.

Performance

The performance is simply the scan time, which is the amount of time required to read the inputs, solve the RLL program and update the outputs.

Instructions and diagnostics

Make sure the unit offers the instructions you need.

Communications

All DL105 units offer one RS-232 port, capable of 9,600 baud.

Specialty features

For the DC input and/or DC output versions, we also offer several high-speed I/O features.

DeviceNet-ready models are also available to supply low-cost I/O nodes for DeviceNet networks.

AC-powered units

F1-130AA
10 AC inputs, 8 AC outputs, 1.7 A/point

F1-130AD
10 AC inputs, 8 DC outputs, 1.0 A/point, two outputs can be used as 7 kHz pulse output, 0.5 A/point

F1-130AR
10 AC inputs, 8 relay outputs, 7 A/point

F1-130DA
10 DC inputs, 4 inputs are filtered inputs, can also be configured as a single 5 kHz high-speed counter, interrupt input, or pulse catch input
8 AC outputs, 1.7 A/point

F1-130DD
10 DC inputs, 4 points are filtered inputs, can also be configured as a single 5 kHz high-speed counter, interrupt input, or pulse catch input
8 DC outputs, 1.0 A/point, 2 outputs can be used as 7 kHz pulse output, 0.5 A/point

F1-130DR
10 DC inputs, 4 inputs are filtered inputs, can also be configured as a single 5 kHz high-speed counter, interrupt input, or pulse catch input
8 relay outputs, 7 A/point

DC-powered units

F1-130DD-D
10 DC inputs, 4 inputs can be used as 5 kHz high-speed counter, interrupt inputs, or pulse catch inputs
8 DC outputs, 1.0 A/point, two outputs can be used as 7 kHz pulse output, 0.5 A/point.

F1-130DR-D
10 DC inputs, 4 inputs can be used as 5 kHz high-speed counter, interrupt inputs, or pulse catch inputs
8 relay outputs, 7 A/point

DeviceNet units

F1-DVNET-AR
10 AC inputs, 8 relay outputs, 7 A/point

F1-DVNET-DD
10 DC inputs, 8 DC outputs (6 outputs at 1A/point and 2 at 0.5A/point)

F1-DVNET-DR
10 DC inputs, 8 relay outputs (outputs 7A/point)

Programming

Handheld programmer...D2-HPP.....<--->
DirectSOFT Programming for Windows
PC-DSOFT5.....<--->
PC-DS100.....Free
PC-R50-U (upgrade).....<--->

Note: Either high-speed input or pulse output can be used, but not in the same configuration.

DL105 CPU Specifications

System capacity

Total memory available (words)	2.4K
Ladder memory (words)	2,048 EEPROM
V-memory (words)	384
User V	256
Non-volatile user V	128
Battery backup	No
Total I/O	18
Inputs	10
Outputs	8
I/O expansion	No

Performance

Contact execution (Boolean)	3.3 μs
Typical scan (1K Boolean)	5-6 ms

Instructions and diagnostics

RLL ladder style	Yes
RLL ^{PLUS} flowchart style (Stages)	Yes/256
Run-time editing	Yes
Variable/fix scan	Variable
Instructions	91
Control relays	256
Timers	64
Counters	64
Immediate I/O	Yes
Subroutines	No
For/next loops	No
Timed interrupt	Yes
Integer math	Yes
Floating-point math	No
PID	No
Drum sequencers	Yes
Bit of word	No
ASCII print	No
Real-time clock/calendar	No
Internal diagnostics	Yes
Password security	Multi-level
System and user error log	No

Communications

Built-in ports	one, RS-232-C
K-sequence (proprietary protocol)	Yes
DirectNET™	No
MODBUS master/slave	No
ASCII out	No
Baud rate (fixed)	9,600 baud

Specialty features

Filtered inputs	Yes ²
Interrupt input	Yes ²
High-speed counter	Yes, 5 kHz ²
Pulse output	Yes, 7 kHz ²
Pulse catch input	Yes ²

1- Our 1K program includes contacts, coils, and scan overhead. If you compare our products to others, make sure you include their scan overhead.

2- Input features are only available on units with DC inputs. Output features are only available on units with DC outputs.

DL105 Hardware Features

CPU status indicators

RUNON	CPU is in RUN mode
OFF	CPU is in PROGRAM mode
PWRON	CPU power good
OFF	CPU power failure
CPUON	CPU internal diagnostics has detected an error
OFF	CPU is OK

Mode control

The DL105 units do not have mode switches like many of our modular CPUs. You can set the unit (using special V-memory locations) so that it will power up in RUN mode.

Communications port

Protocol	K-sequence slave
Devices	Can connect with HPP, DirectSOFT, DV-1000, C-More Panels
Specs	6P6C RJ12 connector
	RS-232-C, 9,600 baud, Odd parity, Fixed station address (1), 8 data bits (one start, one stop bit), Asynchronous, half-duplex, DTE

RJ12 Connector Port 1 Pinout

Pin	Signal
1	0V
2	5V
3	RS-232 Data in
4	RS-232 Data out
5	5V
6	0V

Fixed EEPROM memory

The DL105 units offer built-in EEPROM memory.

NOTE: Terminals accept 16-24 AWG. For 16 AWG, use type TFFN or Type MTW. Other types of 16 AWG may be acceptable, but it really depends on the thickness of the wire insulation.

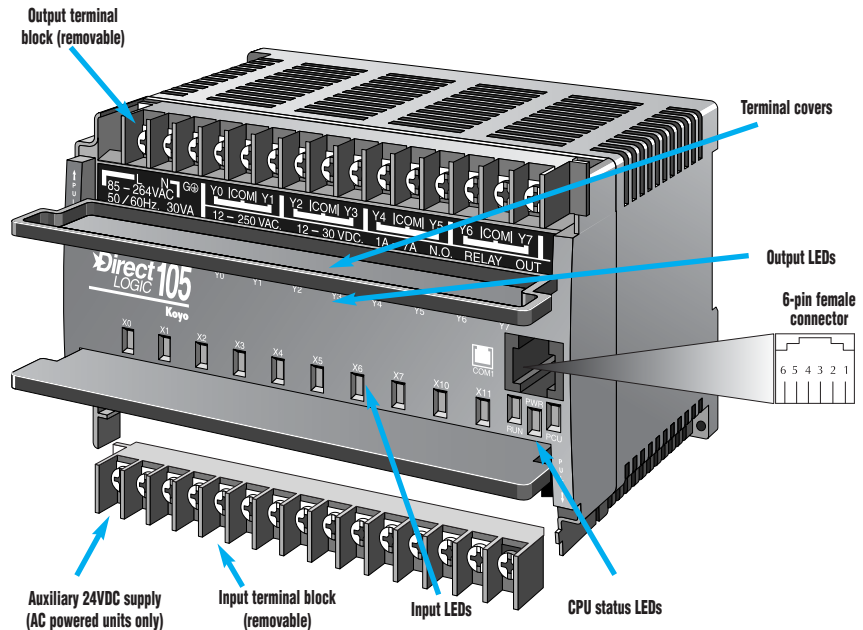

Dimensions and Installation

It is important to understand the installation requirements for your DL105 system. This will help ensure that the DL105 products operate within their environmental and electrical limits.

Plan for safety

This catalog should never be used as a replacement for the user manual. The user manual, D1-USER-M, contains important safety information that must be followed. The system installation should comply with all appropriate electrical codes and standards.

Unit dimensions and mounting orientation

Use the following diagrams to make sure the DL105 system can be installed in your application. DL105 units must be mounted horizontally to ensure proper airflow for cooling purposes. It is important to check these dimensions against the conditions required for your application. For example, we recommend that you leave 2" depth for ease of access and cable clearance; however, your distance may be greater or less. Also, check the installation guidelines for the recommended cabinet clearances.

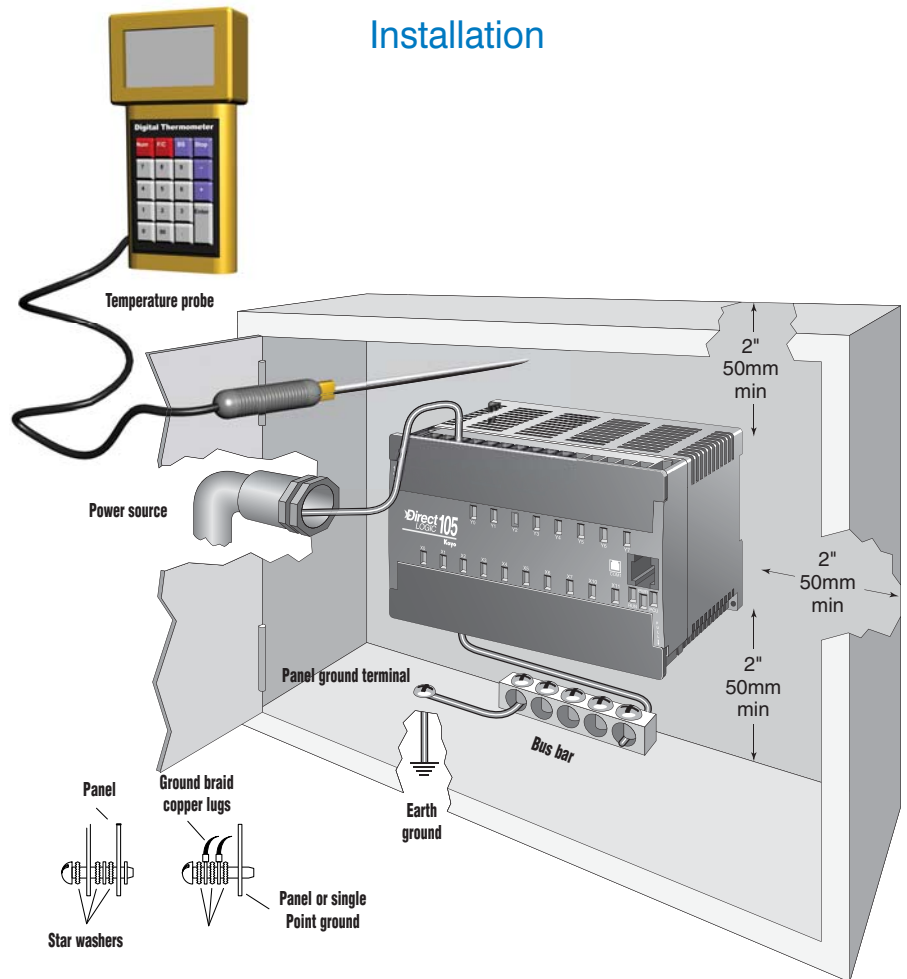

Note: There is a minimum of 2" (50mm) clearance required between the panel door or any devices mounted in the panel door and the nearest DL105 component.

Dimensions and mounting

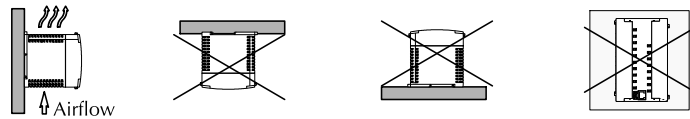

Environmental Specifications	
Storage Temperature	-4°F to 158°F (-20°C to 70°C)
Ambient Operating Temperature	32°F to 131°F (0° to 55°C)
Ambient Humidity	30% to 95% relative humidity (non-condensing)
Vibration Resistance	MIL STD 810C, Method 514.2
Shock Resistance	MIL STD810, Method 516.2
Noise Immunity	NEMA(ICS3-304)
Atmosphere	No corrosive gases

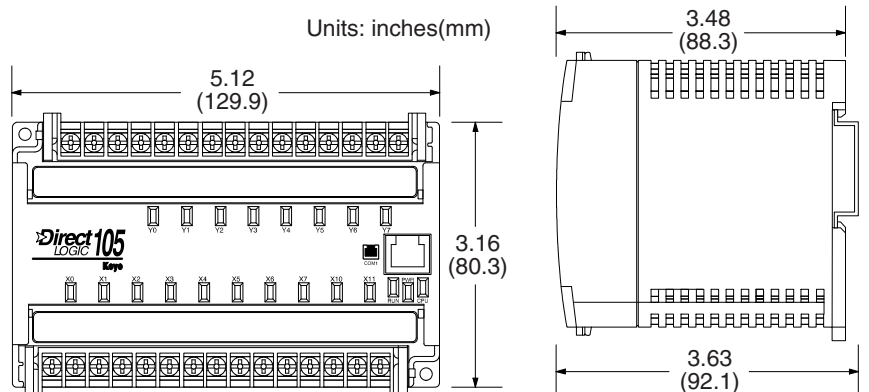

Power Supply and Type of I/O

Power supply options

This product family offers units that operate on 110/220 VAC and 12/24 VDC. Choosing the power supply is probably the most important consideration when specifying a DL105 system, since not all I/O combinations are offered with each power supply option. The table to the right provides the I/O choices and power supply specifications for each type unit.

Choosing the I/O

The DL105 product family offers several different combinations of I/O points. Once you have chosen the power supply option, you need to choose the unit that offers the type of I/O points needed in your application.

Fixed I/O

All DL105 Micro PLCs have "fixed" I/O that is updated on every scan. This means that all units have 10 inputs and 8 outputs, regardless of the actual type of points on the units (DC in/Relay out, DC in/DC out, etc.) The DL105 micro PLC is non-expandable, so you cannot add I/O points. If you are concerned about future system expansion, check our DL06 (36 base I/O expandable to 100 total I/O), or the DL205 micro-modular product family. The DL205 also offers a wide array of features and flexible I/O arrangements with several different base sizes.

Power Supply Options		
Specification	AC Powered Units	24 VDC Powered Units
Part Numbers	F1-130AA, F1-130AR F1-130AD, F1-130DA F1-130DD, F1-130DR F1-DVNET-AR, F1-DEVNET-DD F1-DVNET-DR	F1-130DD-D F1-130DR-D
Voltage Withstand (dielectric)	one minute @ 1,500 VAC between primary, secondary and field ground	
Insulation Resistance	> 10 MΩ @ 500 VDC	
External Power Requirement	85-132 VAC (110 nominal) 170-264 VAC (220 nominal) 100-264 VDC (125 nominal)	10-30 VDC (12 to 24 VDC) with < 10 percent ripple
Auxiliary 24 VDC Output	500 mA max.	Not available
Maximum Inrush Current	12 A	8 A
Maximum Power	30 VA max.	1 A (approx. 10 W)

Addresses automatically assigned

The DL105 uses automatic addressing, so for the vast majority of applications, there is no setup required. We use octal addressing for our products, which means there are no 8s or 9s. The first eight input points use addresses X0-X7, and the last two input points use X10 and X11. If you plan on using the high-speed counting features, there is some very minimal setup required in special V-memory locations.

AC-powered units

Part No.	I/O Mix
F1-130AA	10 Ac in 8 Ac out
F1-130AD	10 Ac in 8 DC out
F1-130AR	10 Ac in 8 relay out
F1-130DA	10 DC in 8 Ac out
F1-130DD	10 DC in 8 DC out
F1-130DR	10 DC in 8 relay out
F1-DVNET-AR	10 Ac in 8 relay out
F1-DVNET-DD	10 DC in 8 DC out
F1-DVNET-DR	10 DC in 8 relay out

DC-powered units

Part No.	I/O Mix
F1-130DD-D	10 DC in 8 DC out
F1-130DR-D	10 DC in 8 relay out

