

# AC Output Modules

F3-08TAS-1 AC Output	
<b>Outputs per Module</b>	8 (1500V point to point isolation)
<b>Commons per Module</b>	8 (isolated)
<b>Operating Voltage</b>	20–125VAC
<b>Output Type</b>	SSR (Triac with zero cross-over)
<b>Peak Voltage</b>	140VAC
<b>AC Frequency</b>	47–63 Hz
<b>ON Voltage Drop</b>	1.6 V(Rms) @ 1.5 A
<b>Maximum Current</b>	1.5A/point
<b>Maximum Leakage Current</b>	0.7 mA (Rms)
<b>Max Inrush Current</b>	15A for 20ms 8A for 100ms
<b>Minimum Load</b>	50mA
<b>Base Power Required</b>	9V 25mA/ON pt (200mA max), 24V N/A
<b>OFF to ON Response</b>	1ms max
<b>ON to OFF Response</b>	9ms max
<b>Terminal Type</b>	Removable
<b>Status Indicators</b>	Logic side
<b>Weight</b>	6.3 oz. (177g)
<b>Fuses</b>	8 (1 per common) 5A, 125V fast blow Order D3-FUSE-4 (5 per pack)

See page tDL3-26 for part numbers of **ZIPLink** cables and connection modules compatible with this I/O module.

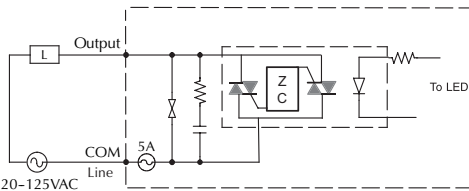
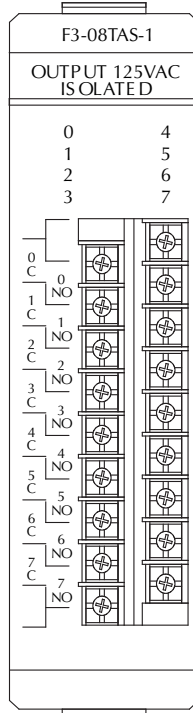
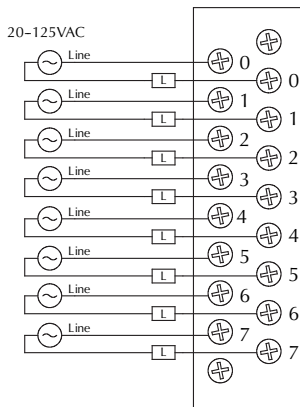
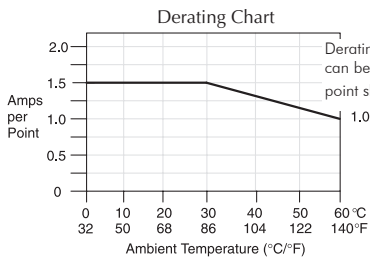

D3-08TA-1 AC Output	
<b>Outputs per Module</b>	8
<b>Commons per Module</b>	2 (isolated)
<b>Operating Voltage</b>	80–265 VAC
<b>Output Type</b>	Triac
<b>Peak Voltage</b>	265VAC
<b>AC Frequency</b>	47–63 Hz
<b>ON Voltage Drop</b>	1.5 VAC @ 1A
<b>Max. Current</b>	1A/point 3A/common
<b>Max Leakage Current</b>	1.2 mA @ 220VAC 0.52 mA @ 110VAC
<b>Max Inrush Current</b>	10A for 16ms 5A for 100ms
<b>Minimum Load</b>	25mA
<b>Base Power Required</b>	9V 20mA/ON pt. (160mA Max) 24V N/A
<b>OFF to ON Response</b>	1ms max
<b>ON to OFF Response</b>	8.33 ms max
<b>Terminal Type</b>	Removable
<b>Status Indicators</b>	Logic side
<b>Weight</b>	7.4 oz. (210g)
<b>Fuses</b>	2 (one 5A per common) non-replaceable

See page tDL3-26 for part numbers of **ZIPLink** cables and connection modules compatible with this I/O module.

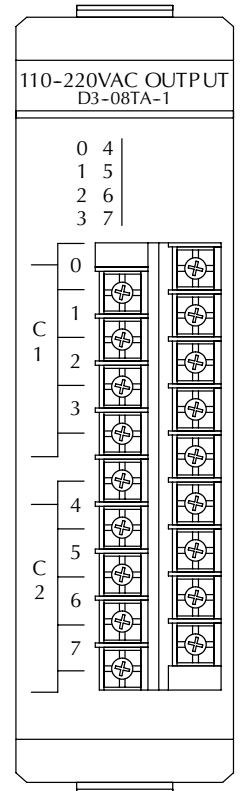
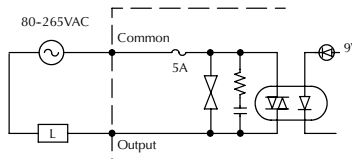
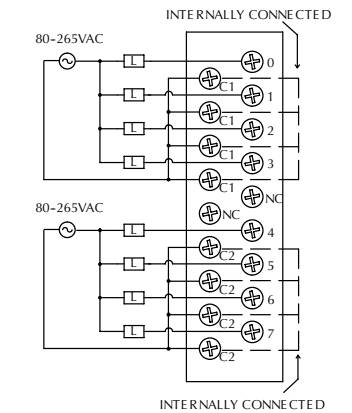
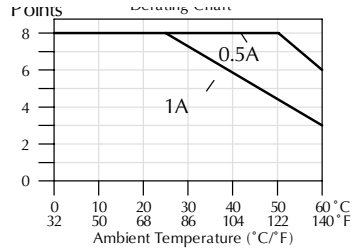

# Power Budget

## Managing your power resource

The I/O configuration depends on your choice of I/O modules, bases and I/O location. When determining the types and quantity of I/O modules you will be using, it's important to remember there is a limited amount of power available from the power supply.

The chart on the next page indicates the power supplied and used by each DL305 device. The adjacent chart shows an example of how to calculate the power used by your particular system. These two charts should make it easy for you to determine if the devices you have chosen fit within the power budget of your system configuration.

If the I/O you have chosen exceeds the maximum power available from the power supply, you can resolve the problem by shifting some of the modules to an expansion base.

## Use ZIPLinks to reduce power requirements

If your application requires a lot of relay outputs, consider using the ZIPLink AC or DC relay output modules. These modules can switch high current (10A) loads without putting a load on your base power budget. Refer to the Wiring Solutions section in this catalog for more information.

This logo is placed next to I/O modules that are supported by the ZIPLink connection systems. See the I/O module specifications at the end of this section.



**WARNING:** It is extremely important to calculate the power budget correctly. If you exceed the power budget, the system may operate in an unpredictable manner, which may result in a risk of personal injury or equipment damage.

## Example: How to calculate your power usage

The following example shows how to calculate the power budget for the DL305 system. The examples are constructed around a single 5-slot base using the devices shown. It is recommended you construct a similar table for each base in your DL305 system.

- Using a chart similar to the one below, fill in column 2.
- Using the tables on the opposite page, enter the current supplied and used by each device (columns 3, 4, and 5). Devices which fall into the "Other" category (Row D) are devices such as the Handheld Programmer or a Data Communication Unit, which also have power requirements, but do not directly plug into the base.

- Add the current used by the system devices (columns 3, 4, and 5), starting with Slot 1, then put the total in the row labeled "Maximum Current Required" (Row E).
- Subtract the row labeled "Maximum Current Required" (Row E), from the row labeled "Current Supplied" (Row B). Place the difference in the row labeled "Remaining Current" (Row F).
- If "Maximum Current Required" is greater than "Current Supplied" in columns 3, 4 or 5, the power budget will be exceeded. It will be unsafe to use this configuration and you will need to restructure your I/O configuration.

A	Column 1	Column 2	Column 3	Column 4	Column 5
<b>Base # 0</b>	Device Type		5 VDC (mA)	9VDC (mA)	24V(mA)
<b>B Current Supplied</b>					
<b>5-slot Base</b>	D3-05BDC		1400	800	500
<b>C Current Required</b>					
<b>CPU Slot</b>	D3-330		300	50	0
<b>Slot 0</b>	D3-16NE3		0	130	0
<b>Slot 1</b>	D3-16NE3		0	130	0
<b>Slot 2</b>	D3-08TA-1		0	160	0
<b>Slot 3</b>	D3-08TA-1		0	160	0
<b>D Other</b>					
	Handheld prog D3-HPP*		50	50	0
<b>E Maximum Current Required</b>			350	630	0
<b>F Remaining Current</b>			1050	170	500

\*Note: D3-HPP is discontinued as of 06/2021.

# DL305 Power Requirements

This section shows the amount of power supplied by the base power supplies and the amount of power used by each DL305 device. Note the base power supplies provide three internal voltages (5V, 9V, 24V). The chart shows how much power from each of these power sources is required for each DL305 device. Use this information when calculating the power budget for your system.

In addition to the three internal power sources, the DL305 bases provide an external power connection. There is 24VDC available from the 24VDC output terminals on the bases (except D3-05BDC and D3-10BDC).

The 24VDC can be used to power external devices or DL305 modules that require external 24VDC. The power used from this external 24VDC output reduces the internal system 24VDC that is available to the modules by an equal amount. When using the 24VDC output at the base terminal, it is recommended that 100mA not be exceeded.

Power Consumed				
Device	5V(mA)	9V(mA)	24V(mA)	Ext req.
<b>CPUs</b>				
D3-330	300	50	0	0
D3-340	300	20	0	0
D3-350	500	0	0	0
<b>DC Input Modules</b>				
D3-08ND2	0	10	112	0
F3-16ND3F	0	148	68	0
<b>AC Input Modules</b>				
D3-08NA-1	0	10	0	0
D3-08NA-2	0	10	0	0
D3-16NA	0	100	0	0
<b>AC/DC Input Modules</b>				
D3-16NE3	0	130	0	0
<b>DC Output Modules</b>				
D3-08TD1	0	20	24	0
D3-08TD2	0	30	0	0
D3-16TD1-1	0	40	96	0
D3-16TD2	0	180	0	0
<b>AC Output Modules</b>				
F3-08TAS-1	0	200	0	0
D3-08TA-1	0	160	0	0
D3-08TA-2	0	160	0	0
F3-16TA-2	0	250	0	0
D3-16TA-2	0	400	0	0

Power Supplied				
Device	5V(mA)	9V(mA)	24V(mA)	24 V (mA)
D3-05B-1	900	2000	500	100
D3-08B-1	900	2000	500	100
D3-10B-1	900	2000	500	100
D3-05BDC	900	2000	500	None
D3-10BDC	900	2000	500	None
D3-05B-NR	900	2000	500	100
D3-05BDC-NR	900	2000	500	None
<b>Power Consumed</b>				
Device	5V(mA)	9V(mA)	24V(mA)	External required
<b>Relay Output Modules</b>				
D3-08TR	0	360	0	0
F3-08TRS-1	0	296	0	0
F3-08TRS-2	0	296	0	0
D3-16TR	0	480	0	0
<b>Analog Temperature and Thermocouple Modules</b>				
F3-04ADS	0	183	50	0
F3-08AD-1	0	45	55	0
F3-08THM-n	0	50	34	0
F3-16AD	0	55	65	0
F3-04DA-1	0	144	108	0
F3-04DAS	0	154	145	0
<b>Communications and Networking</b>				
D3-232 DCU	500	0	0	Optional 5V@500mA
D3-422 DCU	500	0	0	Optional 5V@500mA
<b>Specialty Modules</b>				
D3-HSC	0	70	0	0
D3-TCSU	40	5	0	0
<b>Programming</b>				
D2-HPP	200	0	0	0
<b>Specialty CPUs</b>				
F3-OMUX-1*	409	0	0	0
F3-OMUX-2	262	0	150	0
F3-PMUX	455	0	0	0
F3-RTU	416	0	0	0
<b>Operator Interface</b>				
C-more Micro-Graphic	210	0	0	0

\* F3-OMUX-1 -As of 3/2021 CPU is no longer available from supplier.

## Wiring Solutions using the ZIPLink Wiring System

ZIPLinks eliminate the normally tedious process of wiring between devices by utilizing prewired cables and DIN rail mount connector modules. It's as simple as plugging in a cable connector at either end or terminating wires at only one end. Prewired cables keep installation clean and efficient, using half the space at a fraction of the cost of standard terminal blocks. There are several wiring solutions available when using the ZIPLink System ranging from

PLC I/O-to-ZIPLink Connector Modules that are ready for field termination, options for connecting to third party devices, GS, DuraPulse and SureServo Drives, and specialty relay, transorb and communications modules. Pre-printed I/O specific, adhesive label strips for quick marking of ZIPLink modules are provided with ZIPLink cables. See the following solutions to help determine the best ZIPLink system for your application.

### Solution 1: DirectLOGIC I/O Modules to ZIPLink Connector Modules

When looking for quick and easy I/O-to-field termination, a ZIPLink connector module used in conjunction with a prewired ZIPLink cable, consisting of an I/O terminal block at one end and a multi-pin connector at the other end, is the best solution.

Using the PLC I/O Modules to ZIPLink Connector Modules selector tables located in this section,

1. Locate your I/O module/PLC.
2. Select a ZIPLink Module.
3. Select a corresponding ZIPLink Cable.



### Solution 2: DirectLOGIC I/O Modules to 3rd Party Devices

When wanting to connect I/O to another device within close proximity of the I/O modules, no extra terminal blocks are necessary when using the ZIPLink Pigtail Cables. ZIPLink Pigtail Cables are prewired to an I/O terminal block with color-coded pigtail with soldered-tip wires on the other end.

Using the I/O Modules to 3rd Party Devices selector tables located in this section,

1. Locate your PLC I/O module.
2. Select a ZIPLink Pigtail Cable that is compatible with your 3rd party device.



### Solution 3: GS Series and DuraPulse Drives Communication Cables

Need to communicate via Modbus RTU to a drive or a network of drives?

ZIPLink cables are available in a wide range of configurations for connecting to PLCs and SureServo, SureStep, Stellar Soft Starter and AC drives. Add a ZIPLink communications module to quickly and easily set up a multi-device network.

Using the Drives Communication selector tables located in this section,

1. Locate your Drive and type of communications.
2. Select a ZIPLink cable and other associated hardware.



## Solution 4: Serial Communications Cables

ZIPLink offers communications cables for use with *Direct*LOGIC, CLICK, and Productivity3000 CPUs, that can also be used with other communications devices. Connections include a 6-pin RJ12 or 9-pin, 15-pin and 25-pin D-sub connectors which can be used in conjunction with the RJ12 or D-Sub Feedthrough modules.

Using the **Serial Communications Cables** selector table located in this section,

1. Locate your connector type
2. Select a cable.



## Solution 5: Specialty ZIPLink Modules

For additional application solutions, ZIPLink modules are available in a variety of configurations including stand-alone relays, 24VDC and 120VAC transorb modules, D-sub and RJ12 feedthrough modules, communication port adapter and distribution modules, and SureServo 50-pin I/O interface connection.

Using the **ZIPLink Specialty Modules** selector table located in this section,

1. Locate the type of application.
2. Select a ZIPLink module.



## Solution 6: ZIPLink Connector Modules to 3rd Party Devices

If you need a way to connect your device to terminal blocks without all that wiring time, then our pigtail cables with color-coded soldered-tip wires are a good solution. Used in conjunction with any compatible ZIPLink Connector Modules, a pigtail cable keeps wiring clean and easy and reduces troubleshooting time.

Using the **Universal Connector Modules and Pigtail Cables** table located in this section,

1. Select module type.
2. Select the number of pins.
3. Select cable.





# PLC I/O Modules to ZIPLink Connector Modules - DL305

DL305 PLC Input Module ZIPLink Selector				
PLC		ZIPLink		
Input Module	# of Terms	Component	Module Part No.	Cable Part No.
D3-08ND2	10		See Note 1	
F3-16ND3F	18		See Note 1	
D3-08NA-1	10		See Note 1	
D3-08NA-2	10		See Note 1	
D3-16NA	18		See Note 2	
D3-16NE3	18			

DL305 PLC Analog Module ZIPLink Selector				
PLC		ZIPLink		
Analog Module	# of Terms	Component	Module	Cable
F3-04ADS	18		See Note 2	
F3-08AD-1	18			
F3-16AD	18			
F3-04DA-1	18			
F3-04DAS	18			
F3-08THM-J	T/C Wire Only			

DL305 PLC Output Module ZIPLink Selector				
PLC		ZIPLink		
Output Module	# of Terms	Component	Module Part No.	Cable Part No.
D3-08TD1	10		See Note 1	
D3-08TD2	10		See Note 1	
D3-16TD1-1	18		See Note 2	
D3-16TD2	18			
F3-08TAS-1	18			
D3-08TA-1	18		See Note 1	
D3-08TA-2	10			
F3-16TA-2	18		See Note 2	
D3-16TA-2	18		See Note 1	
D3-08TR <sup>1</sup>	10		See Note 1	
D3-16TR	18		See Note 2	
F3-08TRS-1	18			
F3-08TRS-2	18			

<sup>1</sup>These I/O modules have non-removable terminal blocks which can be terminated using the ZL-CBL24-1P or 2P pigtail cable and the ZL-RTB20 module of the ZIPLink wiring system.

<sup>2</sup> Module is not supported by the ZIPLink wiring system



**NOTE: SEE THE COMPATIBILITY MATRIX TABLES UNDER THE ZIPLINK CONNECTOR MODULES CATALOG SECTION.**



**ZL-CBL24-1P**