

RHINO DC to DC Isolated Converter

This isolated DC to DC power supply is used for eliminating ground loops or addressing isolation issues when interfacing to PLC analog I/O modules. The design features handle many types of configuration problems. The FA-DCDC-1 is a DIN-rail mount, $\pm 10\text{VDC}$, $\pm 5\text{VDC}$ isolated power supply, with each output rated at 125mA. The input voltage range is 12-24V DC $\pm 15\%$ at approximately 6.7 Watts.

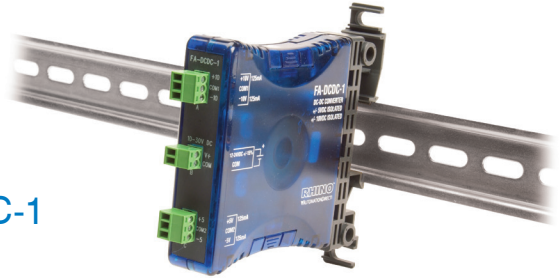

FA-DCDC-1

FA-DCDC-1 General Specifications ¹	
Input Voltage Range	12V to 24VDC $\pm 15\%$
Input Power²	6.7 Watts, Vin 27.6V, 125mA load each channel
Output Voltage³ (25°C)	+5V $\pm 1\%$, 125mA load, -5V $\pm 1\%$ 125mA load +10V $\pm 1\%$ typical, $\pm 2\%$ maximum; -10V $\pm 1\%$ typical, $\pm 2\%$ maximum
Output Current	125mA (per output voltage)
Output Ripple	$\pm 5\text{V}$ channels: <10mV peak to peak, Vin 10.2V 125mA load on both channels $\pm 10\text{V}$ channels: <25mV peak to peak, Vin 10.2V, 125mA load on both channels
Line Regulation⁴	$\pm 5\text{V}$ channels: <10mV, Vin 10.2V to 27.6V, 125mA load on both channels $\pm 10\text{V}$ channels: <20mV, Vin 10.2V to 27.6V, 125mA load on both channels
Load Regulation⁵	$\pm 5\text{V}$ channels: <20mV, Vin 10.2V, 0 - 125mA load variation $\pm 10\text{V}$ channels: <40mV, Vin 10.2V, 0 - 125mA load variation
Isolation	Input to Output: 1500V; $\pm 5\text{V}$ to $\pm 10\text{V}$: 1500V
Inrush Current (50ms)	970mA, Vin 10.2V, 125mA load all channels
Holdup Time (all channels)	30mS minimum, Vin 10V, 125mA load all channels
Overshoot Protection	No overshoot - Turn on and turn off of Vin
Input Protection (reverse DC input voltage)	Up to -50V reverse. \pm Vin reverse polarity connection.
Overload Protection	Auto shutdown. Short circuit. Cycle Vin post event
Output Protection	Indefinite duration. $\pm 5\text{V}$ tied to $\pm 10\text{V}$
Peak Line Transient Voltage	100V for 10mS. Voltage spike on input
Operating Temperature	0 to 60°C (32 to 140°F) full rated
Storage Temperature	-20 to 70°C (-4 to 158°F)
Enclosure	Clear Lexan 221-111 with UN5016 transparent blue colorant
Mounting	35mm wide DIN Rail: part # DN-R35S1 or DN-35HS1; surface mount
Connection	3.5mm screw terminal, 28-16AWG, 1.7 lb-in torque
Relative Humidity	5 to 90% (non-condensing)
Environmental Air	No corrosive gases permitted
Vibration	MIL STD 810C 514.2
Shock	MIL STD 810C 516.2
Noise Immunity	NEMA ICS3-304
Agency Standards and Approvals	UL/cUL listed, UL file E200031, UL508/CSA - C22.2 No. 142-M1987 for ordinary locations. Class I, Division 2, Groups A, B, C, D Hazardous Locations

Notes: 1. All specifications are over the full operating temperature range (0°C to 60°C) unless stated otherwise.
 2. "Channel" means Output Voltage. For example: +5V is one channel and -10V is another.
 3. All output voltage channels are independent of each other. Changing loading on one will have no effect on the other voltage outputs.
 4. LINE Regulation: varying the Input Voltage over entire range (12V to 24V $\pm 15\%$) and the resultant change in the Output Voltage(s) under worst case load conditions (all output channels drawing 125mA).
 5. LOAD Regulation: varying the output loads from no-load to a worst case 125mA load and measuring the resultant change in the Output Voltage(s) under a worst case minimum Input Voltage (10.2V) condition.

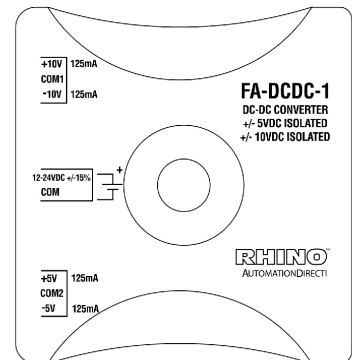
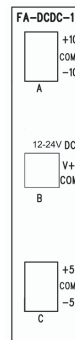
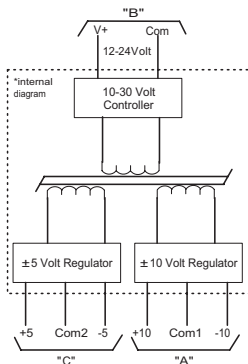

RHINO DC to DC Isolated Converter

Applications

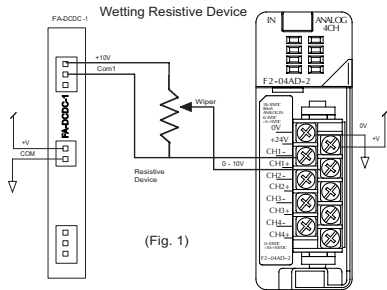

(Fig. 1)

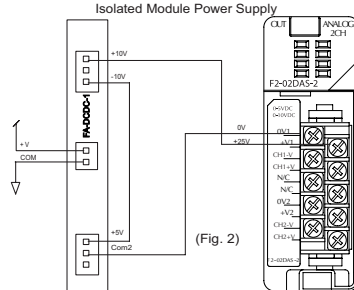

(Fig. 2)

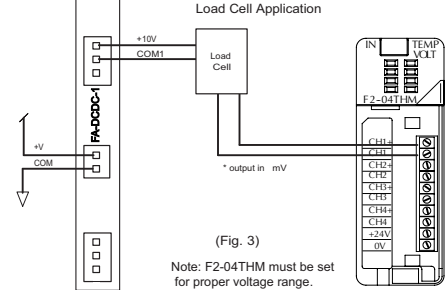

(Fig. 3)

Note: F2-04THM must be set for proper voltage range.

When using a linear potentiometer, the +10V connects to the high side of the potentiometer and the COM1 becomes the zero volt reference. The wiper connects to the analog input. The result is 0 to 10V at the analog module input. (Fig. 1)

Use in a solar/battery application where unregulated 12VDC is available and the analog module requires 24VDC for operation, connect the +10V to +24V module power, connect the -10V to the +5V and the COM2 to the 0V module power. (Fig. 2)

Use to power a load cell application. (Fig. 3)

- THIS EQUIPMENT IS SUITABLE FOR USE IN CLASS I, DIVISION 2/ZONE 2, GROUPS A, B, C AND D, OR NON-HAZARDOUS LOCATIONS ONLY.



WARNING - EXPLOSION HAZARD - SUBSTITUTION OF COMPONENTS MAY IMPAIR SUITABILITY FOR CLASS I, DIVISION 2/ZONE 2.



WARNING - EXPLOSION HAZARD - DO NOT CONNECT OR DISCONNECT CONNECTORS OR OPERATE SWITCHES WHILE CIRCUIT IS LIVE UNLESS THE AREA IS KNOWN TO BE NON HAZARDOUS.

Dimensions, in(mm)

