

FC-3RLY4 Analog Input, 4-Relay, Limit Alarm Module

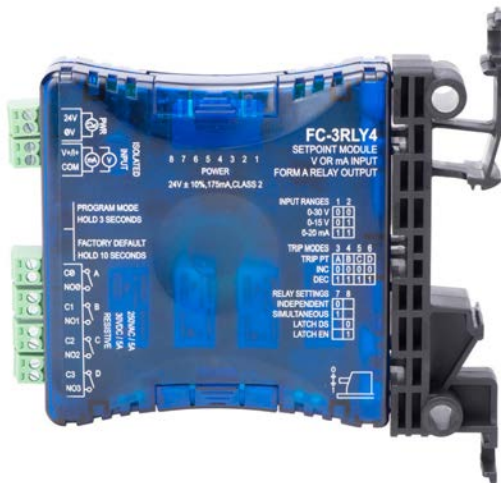

Overview

This is an Analog to Relay Limit Alarm module that is field configurable for a variety of alarm and control applications. The FC-3RLY4 can be powered by 24VAC or 24VDC and accept input signals of 0-15V, 0-30V, or 0-20mA. Configuration and Trip/Release Point programming is accomplished with DIP switches, and a single PGM-pushbutton. LEDs provide an indication of operating status and are used during the Trip/Release Point programming. The module can be 35mm DIN rail or side mounted.



| Specifications | |
|--|--|
| Input Specifications | |
| Number of Inputs and Type | (1) Single Ended, (1) Common |
| Input Ranges | 0-15VDC, 0-30VDC, 0-20mA (DIP Switch Selectable) |
| Input Impedance | 100K Ω voltage input / 250 Ohms current input |
| External DC Power Required | 24 VAC or 24VDC @ 100mA \pm 10% |
| Low-pass Filtering | -3dB at 100Hz, (-6dB per octave) |
| Set/Release Point Voltage Repeatability | 0.05% of full scale Voltage range (Constant temperature) |
| Set/Release Point Current Repeatability | 0.1% of full scale Current range (Constant temperature) |
| Output Specifications | |
| Relay Contacts | 4 SPST, Form A, non-latching |
| Current Contact Rating | 250VAC @ 5A, 30VDC @ 5A (Resistive Load) 380VAC Max., 30VDC Max. |
| Relay Operation | DIP Switch selectable |
| Relay Trip Point Setting | Program Mode enabled by pushbutton |
| Relay Release Point Setting | |
| Relay Dead-band = Trip Point \pm Release Point | 0-15VDC Range: 1.0% minimum deadband (150mV) 0-30VDC Range: 1.0% minimum deadband (300mV) 0-20mA Range: 3.0% minimum deadband (600 μ A) |
| Terminal Block Specifications | |
| Field Wiring | Removable Screw Type Terminal Blocks, (included) |
| Number of Positions | (6) Two Position (Dinkle: EC350V-02P) |
| Wire Range | 28-14 AWG solid or stranded conductor; wire strip length 1/4" (6-7mm) |
| Screw Torque | 1.7 inch-pounds (0.19 Nm) |
| General Specifications | |
| Surrounding Air Temperature | 0 to 60°C (32 to 140°F) IEC 60068-2-14 (Test Nb, Thermal Shock) |
| Storage Temperature | -20 to 70°C (-4 to 158°F) IEC 60068-2-1 (Test Ab, Cold) IEC 60068-2-2 (Test Bb, Dry Heat) IEC 60068-2-14 (Test Na, Thermal Shock) |
| Humidity | 5 to 95% (non-condensing) IEC 60068-2-30 (Test Db, Damp Heat) |
| Environmental Air | No corrosive gases permitted (EN61131-2 pollution degree 1) |
| Vibration | MIL STD 810C 514.2 IEC 60068-2-6 (Test Fc) |
| Shock | MIL STD 810C 516.2 IEC 60068-2-27 (Test Ea) |
| Insulation Resistance | >10 M Ω @ 500 VDC |
| Noise Immunity | NEMA ICS3-304 IEC 61000-4-2 (ESD) Impulse 1000 V @ 1 μ S pulse IEC 61000-4-4 (FTB) RFI, (145 MHz, 440 MHz 5W @ 15 cm) IEC 61000-4-3 (RFI) |
| Weight | 0.3lbs |
| Isolation | 1800 VDC Power to Output 1800 VDC Input to Output applied for 1 second (100% tested) |
| Agency Approvals | UL508**, File Number: E157382, CE |

* The 0V and COM terminals should be considered the same reference point. There is no isolation between the External Power and Input Terminal blocks.

** In order to comply with UL508, the supplied power must be less than 26 VDC and fused at a maximum of 3 amps.

FC-3RLY4 Modes of Operation

Independent and Simultaneous Relay Control Modes

Independent Relay Control Mode

- Relays A, B, C and D are controlled with independent Trip Points and Release Points for each relay. All relays can be independently set to operate in Increasing or Decreasing mode (see next section). This mode can be used to control multiple loads in sequence, or monitor for multilevel alarm conditions.

Simultaneous Relay Control Mode

- Relays A and B operate simultaneously, both controlled by Trip Point A and Release Point A settings. Both relays operate in Increasing or Decreasing mode (see next section).
- Relays C and D operate simultaneously, both controlled by Trip Point B and Release Point B settings. Both relays operate in Increasing or Decreasing mode (see next section).
- This mode can be used where it is desired to have two relays controlled by common Trip and Release Points such as using one relay for local alarm indication with a horn or strobe and the other relay for remote alarm monitoring by a PLC.

Relay Trip Point / Release Point Control Modes

Increasing (INC) Mode

The relay will turn ON when the input signal increases to the programmed Trip Point. The relay will remain ON until the input signal decreases below the Release Point. In INC mode, the Trip Point must always be greater than the Release Point (TP > RP).

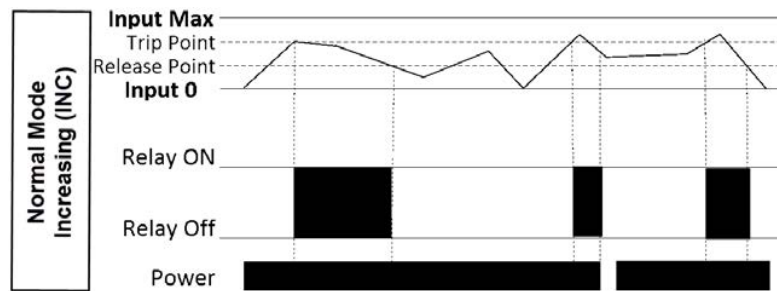

Decreasing (DEC) Mode

The relay will turn on when the input signal decreases below the programmed trip point. The relay will remain on until the input signal increases above the release point. In DEC mode, the Trip Point must always be less than the release point (TP < RP).

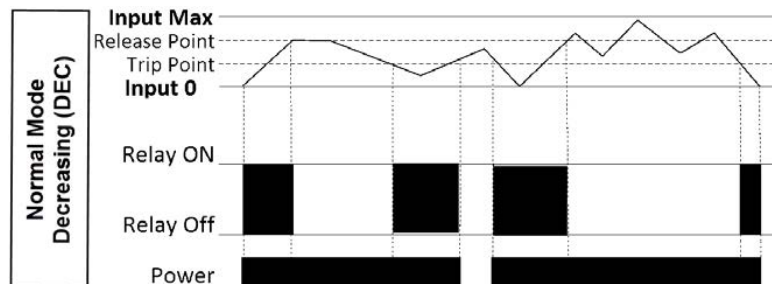

FC-3RLY4 Modes of Operation (continued)

Non-Latching and Latching Relay Control Modes

Non-Latching Relay Control Mode

All relays operate automatically at the Trip and Release Point settings.

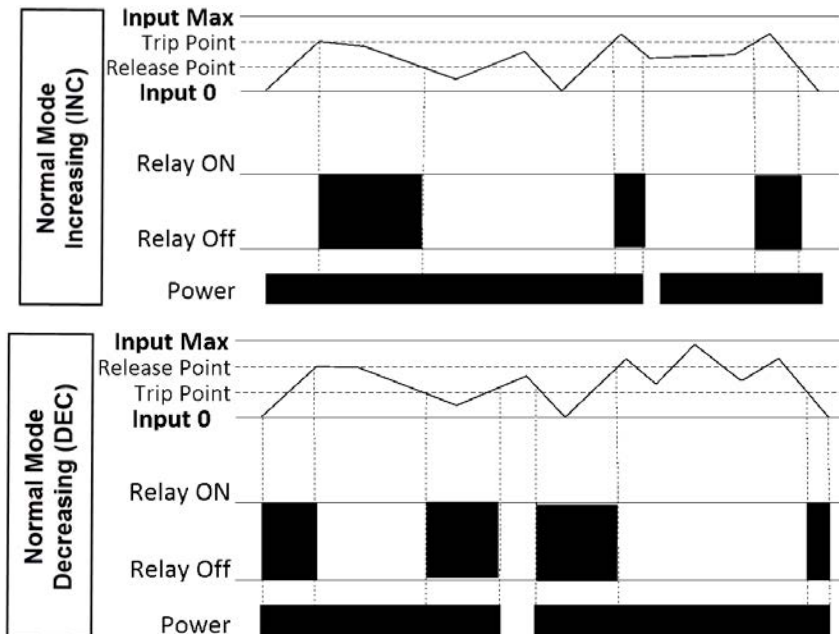

Latching Relay Control Mode

All relays operate automatically at the Latch Trip Point settings and remain *electrically* latched until the input signal reaches the Manual Release Point, at which time the FC-3RLY4 relays can be manually reset by pressing the PGM-pushbutton as shown in the following diagrams.

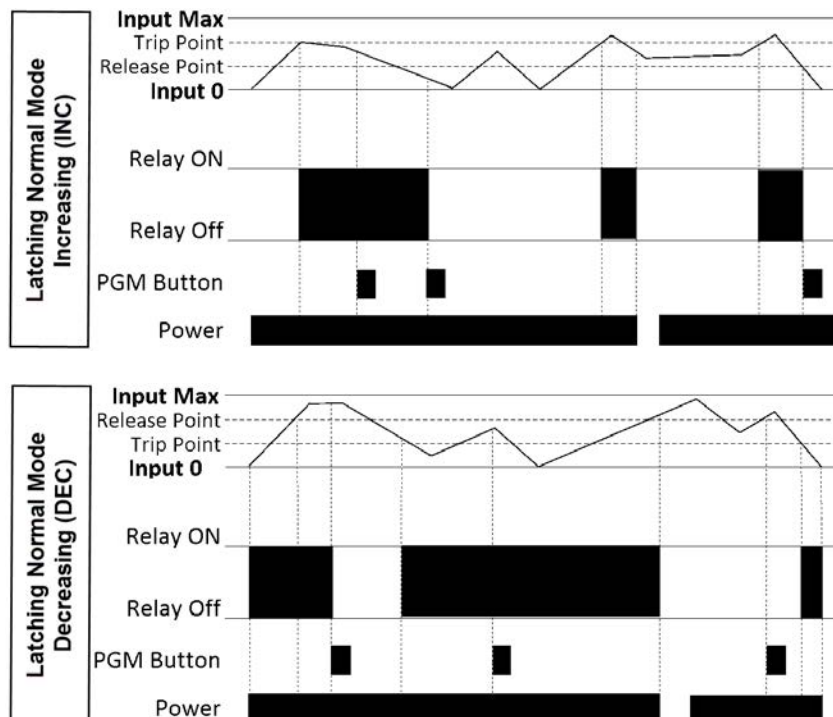

FC-3RLY4 Dimensions

Wiring Connections

| Power Terminal Block | |
|----------------------|--------------------------------|
| Faceplate Label | Description |
| 24V | 24VAC/VDC $\pm 10\%$ (Class 2) |
| 0V | 0V |

| Input Terminal Block | |
|----------------------|------------------------|
| Faceplate Label | Description |
| V+ / I+ | Voltage + / Current In |
| COM | Input Common |

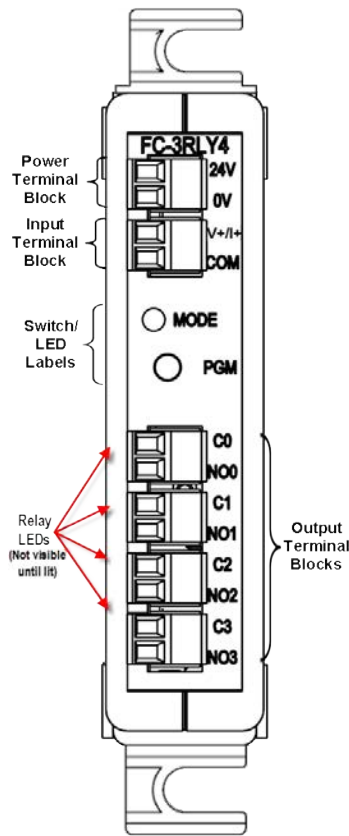

| Switch/LED Labels | |
|-------------------|---|
| Faceplate Label | Description |
| MODE | Diagnostic LED flashing indication |
| PGM | Pushbutton switch input to initiate programming, etc. |

| Output Terminal Block | |
|-----------------------|----------------------------|
| Faceplate Label | Description |
| C0/NO0 | Common # / Normally Open # |
| C1/NO1 | |
| C2/NO2 | |
| C3/NO3 | |

Dimensions

mm [inches]

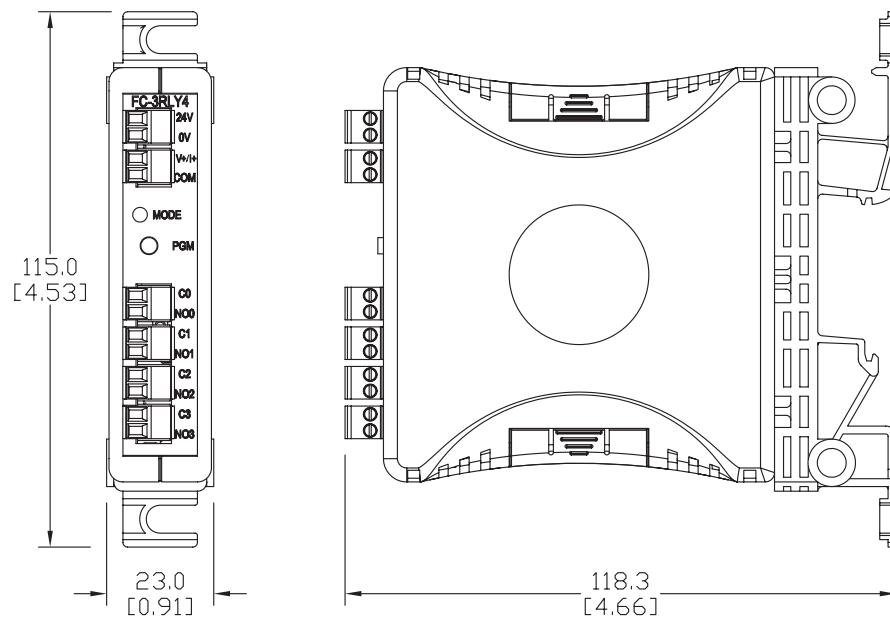

FC Series Accessories



FC-5MM



FC-35MM

Description

Universal terminal block replacements for the FC Series signal conditioners. Each package includes enough terminal blocks to replace all the terminal blocks on any FC Series signal conditioner according to the following table:

| FC Series Terminal Blocks | | |
|---------------------------|--|--|
| FC Series Model | Terminal Block Replacement Part Number | Package Includes |
| FC-11 | FC-5MM | (2) 2-pole blocks (2) 3-pole blocks (1) 4-pole blocks |
| FC-33 | | |
| FC-R1 | | |
| FC-T1 | | |
| FC-ISO-C | FC-35MM | (6) 2-pole blocks (2) 3-pole blocks (2) 4-pole blocks (1) 5-pole blocks (1) 6-pole blocks (2) 8-pole blocks |
| FC-ISO-D | | |
| FC-B34 | | |
| FC-35B | | |
| FC-P3 | | |
| FC-3RLY2 | | |
| FC-3RLY4 | | |

Note: Depending on the model, some terminal blocks in the package may be unused.

| Universal Signal Conditioners | | | | |
|-------------------------------|--|--------------------|--------------|-------|
| Part No. | Description | Rated Torque (N·m) | Weight (Lbs) | Price |
| FC-5MM | Terminal block, replacement, 5mm. Package of 5. For use with FC Series signal conditioners. | 0.5 | 0.1 | |
| FC-35MM | Terminal block, replacement, 3.5mm. Package of 14. For use with FC Series signal conditioners. | 0.2 | 0.1 | |

FC Series Signal Conditioners



FC-33

DC Selectable Signal Conditioner with 3-way isolation

Field configurable input and output ranges of 0-5V, 0-10 V, 0-20 mA and 4-20 mA with 1500 VDC isolation between input and output, and 1500 VDC isolation from 24 volt power and input/output. LED indicates normal operation and is used in conjunction with the calibration pushbutton for the internal calibration process.

- 3-way 1500 V isolation
- Push button calibration



FC-T1

Thermocouple/mV Isolated Signal Conditioner

Field configurable input for type J, K, E, T, R, S, B, N and C thermocouples or ± 156.25 mV inputs with 1500 VDC isolation between input and the 4-20 mA output. Cold junction compensation and burnout detection. Alarm/run LED.

- 1500 V isolation
- Cold junction compensation (CJC)
- Internal diagnostics (burnout detection or calibration errors)



FC-35B

Unipolar Voltage or Current to Bipolar Voltage Signal Conditioner

Field configurable input and output, unipolar input ranges of 0-5V, 0-10 V, 0-20 mA or 4-20 mA, and bipolar output ranges of ± 100 mV, ± 50 mV, ± 5 V, ± 10 V, ± 15 V. Field calibrated with offset and span adjustments.



FC-3RLY2

Analog Input, 2-Relay, Limit Alarm

Field configurable analog to relay limit alarm powered by 24VAC/VDC and Input signal ranges of 0-15V, 0-30V or 0-20mA. Trip/Release Point programmed via DIP switches. LED's indicate operating status.



FC-ISO-D

Encoder Signal Conditioner and Optical Isolator - Differential Line Driver Output

Ideal for use with single-ended (open collector, NPN, pull-up, push-pull, totem pole) or differential line driver encoders. Three complementary inputs (A, B, Z, A-not, B-not, Z-not) are rated for 4.5-7.5 and 12-26 VDC and frequency response up to 1 MHz.

Optical isolation separates the input signals from three differential line driver outputs (A, B, Z, A-not, B-not, Z-not) rated for 5VDC.



FC-11

4-20 mA Isolated Signal Conditioner

Loop powered 4-20 mA input/output signal with 1500 VDC isolation between input and output.

- 1500 V isolation
- Loop powered



FC-R1

RTD Input Signal Conditioner

Loop powered, non-isolated, 3-wire unit converts an RTD input to a linear 4-20 mA signal. User selectable CU10, PT100 or PT1000 input.



FC-P3

Potentiometer Input, Analog Output Signal Conditioner

Field configurable input and output, input ranges of 3-wire potentiometer 0 to 100 ohms through 0 to 100 kilohms, and output ranges of 0-5V, 0-10 V, 0-20 mA or 4-20 mA. Field calibrated to 10% of potentiometer full range.



FC-B34

Bipolar Voltage to Unipolar Voltage or Current Signal Conditioner

Field configurable input and output, bipolar input ranges of ± 100 mV, ± 50 mV, ± 5 V, ± 10 V, ± 15 V, and unipolar output ranges of 0-5V, 0-10 V, 0-20 mA or 4-20 mA. Field calibrated with offset and span adjustments.



FC-3RLY4

Analog Input, 4-Relay, Limit Alarm

Field configurable analog to relay limit alarm powered by 24VAC/VDC and Input signal ranges of 0-15V, 0-30V or 0-20mA. Trip/Release Point programmed via DIP switches. LED's indicate operating status.



FC-ISO-C

Encoder Signal Conditioner and Optical Isolator - Open Collector Output

Ideal for use with single-ended (open collector, NPN, pull-up, push-pull, totem pole) or differential line driver encoders. Three complementary inputs (A, B, Z, A-not, B-not, Z-not) are rated for 4.5-7.5 and 12-26 VDC and frequency response up to 1 MHz.

Optical isolation separates the input signals from three complementary open collector outputs (A, B, Z, A-not, B-not, Z-not) rated for 5-36 VDC that can be used in single-ended configurations.