

Fuji Duo Series SC-E Contactors

Features

- 5 to 100 hp at 480 VAC
- cULus and CSA approval, CE mark, meets JIS and IEC standards.
- Models SC-E02-xxx to SC-E4-xxx have 3-pole main circuits and come in three sizes with widths of 43 mm, 54 mm, and 67 mm.
- Models SC-E1-xxx to SC-E7-xxx employ a box terminal structure; allowing wires to be connected directly to the main circuit.
- Has a finger-protection terminal structure that prevents the exposure of live parts.
- Models SC-E5-xxx to SC-E7-xxx use a SUPERMAGNET™ (AC-input/DC-output operation) for high operating reliability and requires no surge suppressor.

Small Size

- SC-E02-xxx to E05-xxx: 43mm wide
- SC-E1-xxx to E25-xxx: 54mm wide
- SC-E3-xxx, E4-xxx: 67mm wide
- SC-E5-xxx: 88mm wide



SC-E2S



SC-E7

Safety

- Terminals with finger-touch protection (DIN 57106/VDE 0106 Teil100)

Utility

- Box lug terminal construction
- Long electrical life
- Easy to wire

Environmental

- Low power consumption
- Recycled thermoplastic resin used for plastic parts.
- The names of materials are indicated on all major parts to facilitate recycling

Standards & Approvals

- UL listed, file E42419, Standard UL 508
- cUL listed, file E42419, Standard CSA C 22.2 No.14
- VDE 0660
- JIS C 8201-4-1
- IEC 60947-4-1 / EN 60947-4-1
- CE compliant

Optional accessories

- Auxiliary contact blocks
- Coil surge suppression units
- Replacement coils for contactor sizes SC-E5 and larger

SC-E Series Contactors Specifications - UL and CSA													
Model	Price	Nominal Coil Voltage	Rated Capacity (HP)						Rated AC-3 Current (A) [note 1]	Rated AC-1 Thermal Current (A) [note 2]	SCCR Ratings (KA)	Rated Insulation Voltage (V)	Frame Width (mm)
			3-Phase Motor				1-Phase Motor						
			200V	220-240V	440-480V	550-600V	100-120V	220-240V					
SC-E02-24VAC		24VAC	2	2	5	5	1/3	1	9	20	5	690	43
SC-E02-110VAC		110VAC											
SC-E02-220VAC		220VAC											
SC-E02-440VAC		440-480VAC											
SC-E02-500VAC		500-550VAC											
SC-E02G-24VDC		24VDC											
SC-E03-24VAC		24VAC	3	3	7.5	7.5	1/2	2	12	20			
SC-E03-110VAC		110VAC											
SC-E03-220VAC		220VAC											
SC-E03-440VAC		440-480VAC											
SC-E03-500VAC		500-550VAC											
SC-E03G-24VDC		24VDC											
SC-E04-24VAC		24VAC	5	5	10	10	1	3	18	25			
SC-E04-110VAC		110VAC											
SC-E04-220VAC		220VAC											
SC-E04-440VAC		440-480VAC											
SC-E04-500VAC		500-550VAC											
SC-E04G-24VDC		24VDC											
SC-E05-24VAC		24VAC	5	7.5	15	15	2	3	25	32			
SC-E05-110VAC		110VAC											
SC-E05-220VAC		220VAC											
SC-E05-440VAC		440-480VAC											
SC-E05-500VAC		500-550VAC											
SC-E05G-24VDC		24VDC											

TABLE CONTINUED NEXT PAGE

Notes: 1. AC3 type loads consist of squirrel cage three-phase motors; occasional, limited jogging duty.
 2. AC1 non-inductive or slightly inductive loads. Typically resistive loads (i.e. furnaces, ovens, etc.)

Fuji Duo Series SC-E Contactors

SC-E Series Contactors Specifications - UL and CSA													
Model	Price	Nominal Coil Voltage	Rated Capacity (HP)						Rated AC-3 Current (A) [note 1]	Rated AC-1 Thermal Current (A) [note 2]	SCCR Ratings (KA)	Rated Insulation Voltage (V)	Frame Width (mm)
			3-Phase Motor				1-Phase Motor						
			200V	220-240V	440-480V	550-600V	100-120V	220-240V					
SC-E1-24VAC		24VAC	7.5	10	25	25	2	3	32	50	690	54	
SC-E1-110VAC		110VAC											
SC-E1-220VAC		220VAC											
SC-E1-440VAC		440-480VAC											
SC-E1-500VAC		500-550VAC											
SC-E1G-24VDC		24VDC											
SC-E2-24VAC		24VAC	10	15	30	30	3	5	40	60	690	54	
SC-E2-110VAC		110VAC											
SC-E2-220VAC		220VAC											
SC-E2-440VAC		440-480VAC											
SC-E2-500VAC		500-550VAC											
SC-E2G-24VDC		24VDC											
SC-E2S-24VAC		24VAC	15	20	30	30	3	10	50	65	690	54	
SC-E2S-110VAC		110VAC											
SC-E2S-220VAC		220VAC											
SC-E2S-440VAC		440-480VAC											
SC-E2S-500VAC		500-550VAC											
SC-E2SG-24VDC		24VDC											
SC-E3-24VAC		24VAC	20	25	50	50	5	15	65	100	690	67	
SC-E3-110VAC		110VAC											
SC-E3-220VAC		220VAC											
SC-E3-440VAC		440-480VAC											
SC-E3-500VAC		500-550VAC											
SC-E3G-24VDC		24VDC											
SC-E4-24VAC		24VAC	25	30	50	50	5	15	80	105	690	67	
SC-E4-110VAC		110VAC											
SC-E4-220VAC		220VAC											
SC-E4-440VAC		440-480VAC											
SC-E4-500VAC		500-550VAC											
SC-E4G-24VDC		24VDC											
SC-E5-24V		24VAC/VDC	30	30	60	75	7.5	15	105	150	690	88	
SC-E5-100V		110VAC/VDC											
SC-E5-200V		220VAC/VDC											
SC-E5-400V		380-450VAC											
SC-E5-500V		460-575VAC											
SC-E6-24V		24VAC/VDC	40	40	75	100	10	20	125	150	690	100	
SC-E6-100V		110VAC/VDC											
SC-E6-200V		220VAC/VDC											
SC-E6-400V		380-450VAC											
SC-E6-500V		460-575VAC											
SC-E7-24V		24VAC/VDC	50	50	100	125	15	25	150	200	690	115	
SC-E7-100V		110VAC/VDC											
SC-E7-200V		220VAC/VDC											
SC-E7-400V		380-450VAC											
SC-E7-500V		460-575VAC											

Notes: 1. AC3 type loads consist of squirrel cage three-phase motors; occasional, limited jogging duty.
 2. AC1 non-inductive or slightly inductive loads. Typically resistive loads (i.e. furnaces, ovens, etc.)

Fuji Duo Series SC-E Contactors

SC-E Series Contactors Specifications - IEC												
Contactor Type	Rated Capacity (kW)				Rated Operating Current (A)						Rated Thermal Current (A)	Internal Auxiliary Contact Arrangement
	3-Phase Motor AC-3 / AC-4				3-Phase Motor AC-3 / AC-4				Resistive Load AC-1			
	200-240V	380-440V	500-550V	600-690V	200-240V	380-440V	500-550V	600-690V	200-240V	380-440V		
SC-E02(G)-xxx	2.2 / 2.2	4 / 4	4 / NA	4 / NA	9 / 9	9 / 9	7 / NA	5 / NA	20	20	20	-
SC-E03(G)-xxx	3 / 3	5.5 / 5.5	5.5 / NA	5.5 / NA	12 / 12	12 / 12	9 / NA	7 / NA	20	20	20	-
SC-E04(G)-xxx	4 / 4	7.5 / 7.5	7.5 / NA	7.5 / NA	18 / 18	18 / 18	13 / NA	9 / NA	25	25	25	-
SC-E05(G)-xxx	5.5 / 4	11 / 7.5	11 / NA	7.5 / NA	25 / 18	25 / 18	17 / NA	9 / NA	32	32	32	-
SC-E1(G)-xxx	7.5 / 7.5	15 / 15	15 / NA	11 / NA	32 / 32	32 / 32	24 / NA	15 / NA	50	50	50	-
SC-E2(G)-xxx	11 / 11	18.5 / 18.5	18.5 / NA	15 / NA	40 / 40	40 / 40	29 / NA	19 / NA	60	60	60	-
SC-E2S(G)-xxx	15 / 11	22 / 18.5	25 / NA	22 / NA	50 / 40	50 / 40	38 / NA	26 / NA	65	65	65	-
SC-E3(G)-xxx	18.5 / 18.5	30 / 30	37 / NA	30 / NA	68 / 68	65 / 65	60 / NA	38 / NA	100	100	100	-
SC-E4(G)-xxx	22 / 18.5	40 / 30	37 / NA	37 / NA	80 / 68	80 / 65	60 / NA	44 / NA	105	105	105	-
SC-E5-xxx	30 / 30	55 / 55	5 5 / NA	55 / NA	105 / 105	105 / 105	85 / NA	64 / NA	150	150	150	2NO+2NC
SC-E6-xxx	37 / 37	60 / 60	6 0 / NA	60 / NA	125 / 125	125 / 125	90 / NA	72 / NA	150	150	150	2NO+2NC
SC-E7-xxx	45 / 45	75 / 75	75 / NA	90 / NA	150 / 150	150 / 150	120 / NA	103 / NA	200	200	200	2NO+2NC

Internal Auxiliary Contact Ratings

Internal Auxiliary Contact Ratings - UL and CSA						
Frame Size <small>(note 1)</small>	Rated Insulation Voltage (V)	NEMA ICS 5-2000 Ratings <small>(note 2)</small>				
		AC Ratings			DC Ratings	
		Designation	Making VA	Breaking VA	Designation	Making/Breaking VA
E5 to E7-xxx	690	A600	7200	720	Q300	69

Notes:

- E02(G) to E4(G) do not have internal auxiliary contact.
- NEMA ICS 5-2000. For more information, refer to Control Circuit Contact Electrical Ratings, see page MRC-111.

Internal Auxiliary Contact Ratings - IEC, JIS									
Based on IEC 60974-4-1, EN 60947-4-1, JIS C 8201-4-1									
Frame Size <small>(note 1)</small>	Rated Insulation Voltage (V)	Rated Thermal Current (A)	Making and Breaking Capacity (A)		Rated Operational Current (A)			Minimum Operating Voltage and Current	
			AC Voltage	Amps	AC Voltage	AC-15 (Ind. load)	DC Voltage		DC-13 (Ind. load)
E5 to E7-xxx	690	10	120V	60	120V	6	24V	3	5VDC, 3mA
			220V	30	220V	3	48V	1.5	
			440V	15	440V	1.5	110V	0.55	
			600V	12	600V	1.2	220V	0.27	

Note 1: E02(G) to E4(G) do not have internal auxiliary contact.

Fuji Duo Series SC-E Contactors

Coil Characteristics

AC Coil Characteristics								
Frame Size	Power Consumption (VA)		Power Loss (W)		Pick-Up Voltage (V)	Drop-Out Voltage (V)	Operating Time (ms)	
	Inrush	Sealed	50Hz	60Hz			Coil ON to Contact ON	Coil OFF to Contact OFF
	50/60Hz	50/60Hz						
E02 to E05-xxx	90/95	9/9	2.7	2.8	0.85 - 1.1 x U.S. rated coil voltage	0.2 - 0.75 x U.S. rated coil voltage	9-20	5-16
E1 to E2S-xxx	120/135	12.7/12.4	3.6	3.8	0.85 - 1.1 x U.S. rated coil voltage	0.2 - 0.75 x U.S. rated coil voltage	10-17	6-13
E3, E4-xxx	180/190	13.3/13.4	4.5	5	0.85 - 1.1 x U.S. rated coil voltage	0.2 - 0.75 x U.S. rated coil voltage	10-18	8-18
E5-xxx	80/95	4/4.6	3.2	3.6	0.85 - 1.1 x U.S. rated coil voltage	0.2 - 0.75 x U.S. rated coil voltage	39-45	27-33
E6, E7-xxx	190/230	4.9/5.8	3.4	3.7	0.8 - 1.1 x U.S. rated coil voltage	0.1 - 0.65 x U.S. rated coil voltage	31-37	30-36

DC Coil Characteristics						
Frame Size	Power Consumption (W)		Pick-Up Voltage (V)	Drop-Out Voltage (V)	Operating Time (ms)	
	Inrush	Sealed			Coil ON to Contact ON	Coil OFF to Contact OFF
E02G to E05G-xxx	7	7	0.85 - 1.1 x U.S. rated coil voltage	0.1 - 0.75 x U.S. rated coil voltage	45-49	10-26
E1G to E2SG-xxx	9	9	0.85 - 1.1 x U.S. rated coil voltage	0.1 - 0.75 x U.S. rated coil voltage	40-50	8-17
E3G, E4G-xxx	12	12	0.85 - 1.1 x U.S. rated coil voltage	0.1 - 0.75 x U.S. rated coil voltage	60-70	14-21
E5-xxx	90	2.8	0.85 - 1.1 x U.S. rated coil voltage	0.1 - 0.75 x U.S. rated coil voltage	35-41	26-32
E6, E7-xxx	225	3.2	0.8 - 1.1 x U.S. rated coil voltage	0.1 - 0.65 x U.S. rated coil voltage	28-34	27-33

Operating Coil	
AC Coil, SC-E02-xxx to SC-E4-xxx	
Voltage Code	Coil Operating Voltage / Frequency
24VAC	24VAC 50Hz / 24-26VAC 60Hz
110VAC	100-110VAC 50Hz / 110-120VAC 60Hz
220VAC	200-220VAC 50Hz / 220-240VAC 60Hz
440VAC	415-440VAC 50Hz / 440-480VAC 60Hz
500VAC	480-500VAC 50Hz / 500-550VAC 60Hz

Operating Coil	
AC/DC Coil (SUPERMAGNET), SC-E5-xxx to SC-E7-xxx	
Voltage Code	Coil Operating Voltage / Frequency
24V	24-25VAC 50/60Hz; 24VDC
100V	100-127VAC 50/60Hz; 100-120VDC
200V	200-250VAC 50/60Hz; 200-240VDC
400V	380-450VAC 50/60Hz
500V	460-575VAC 50/60Hz

Operating Coil	
DC Coil, SC-E02G-xxx to SC-E4G-xxx	
Voltage Code	Coil Operating Voltage
24VDC	24VDC

Performance Data

Frame size	Making current (A)		Breaking current (A)		Operating cycles per hour	Durability (operations)	
	220V	440V	220V	440V		Electrical	Mechanical
SC-E02	108	108	90	90	1800	2 million	10 million
SC-E03	144	144	120	120	1800	1.5 million	10 million
SC-E04	216	216	180	180	1800	1.5 million	10 million
SC-E05	250	250	200	200	1200	1.5 million	10 million
SC-E1	384	384	320	320	1200	1.5 million	10 million
SC-E2	480	480	400	400	1200	1.5 million	10 million
SC-E2S	500	500	400	400	1200	1.5 million	10 million
SC-E3	816	780	680	650	1200	1.5 million	5 million
SC-E4	816	800	680	650	1200	1 million	5 million
SC-E5	1260	1260	1050	1050	1200	1 million	5 million
SC-E6	1500	1500	1250	1250	1200	1 million	5 million
SC-E7	1800	1800	1500	1500	1200	1 million	5 million

Fuji Duo Series SC-E Contactors

Standard operating conditions

The magnetic contactors are manufactured for use in the standard operating conditions given in the table.

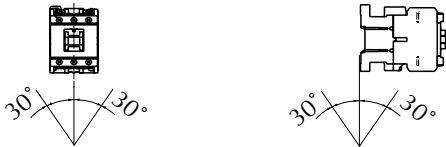

Standard Operating Conditions	
Ambient Temperature	Operating: -5 to 55°C No sudden temperature changes resulting in condensation or icing (The average temperature over a 24-hour period must not exceed 35°C) Storage: -40 to 65°C
Humidity	45 to 85%RH
Altitude	2000m or lower
Atmosphere	No excessive dust, smoke, corrosive gases, flammable gases, steam, or salt
Vibration	10 to 55Hz 15m/s ²
Shock	50m/s ²
Mounting	35mm IEC DIN rail mounting (SC-E02 to SC-E4), screw mounting
Mounting Angle	
Standard	IEC 947-4-1, EN 60947-4-1, VDE 0660 JIS C 8201-4-1, JEM 1038 UL 508, file E42419; CSA C22.2, file 20479

Wiring

Be sure to perform wiring correctly with reference to the wiring diagrams. Main terminals for models SC-E02 to SC-E7 are wired using solid wires or stranded wires. Stranded wires or flexible stranded wires can be connected by twisting them together and crimping a sleeve (ferrule) onto them before connecting.

Tightening torque

If wires are not tightened sufficiently, they may become hot or loosen, resulting in a fire, short-circuit, electric shock, or other potentially dangerous situation. Tighten wires to the torques specified in these tables.

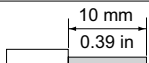
Wire Sizes, Tightening Torques - Control Circuit		
Solid or Stranded Wire (mm²)	One	0.75 to 2.5 (1 to 1.6 mm diameter)
	Two	0.75 to 2.5 (1 to 1.6 mm diameter)
AWG	One	18 to 14
	Two	18 to 14
Insulation Stripping Length		
Fork Terminal	Max. 7.7mm wide	
Terminal Screw Size	M3.5	
Tool	Phillips screwdriver, H-type, No. 2 (ISO 8764); ADC part number DN-SP1 or DN-SP2 Flat-blade screwdriver, 1 x 5.5 x L-type, B (ISO 2830); ADC part number DN-SS5	
Tightening Torque (N·m)	0.8 to 1	

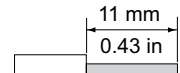
Wire Sizes, Tightening Torques - Main Circuit					
Contactor Type		SC-E02-xxx	SC-E03-xxx	SC-E04-xxx	SC-E05-xxx
Solid Wire (mm²)	One	0.75 to 4		0.75 to 6	
	Two	1 to 4		1.5 to 6	
Stranded Wire (mm²)	One	0.75 to 4		0.75 to 6	
	Two	1 to 4		1.5 to 6	
AWG	One	12 max.		10 max.	
	Two	12 max.		10 max.	
Insulation Stripping Length					
Terminal Screw Size	M4				
Tool	Phillips screwdriver, H-type, No. 2 (ISO 8764); ADC part number DN-SP1 or DN-SP2 Flat-blade screwdriver, 1 x 5.5 x L-type, B (ISO 2830); ADC part number DN-SS5				
Tightening Torque (N·m)	1.2 to 1.5				

Fuji Duo Series SC-E Contactors

Wire Sizes, Tightening Torques - Main Circuit						
Contactor Type		SC-E1, E2, E2S-xxx	SC-E3, E4-xxx	SC-E5, E6-xxx	SC-E7-xxx	
Top-Only Connection	Solid or stranded wire (mm ²) ¹		0.75 to 35	1.5 to 70	4 to 70	4 to 120
	Flexible stranded wire with sleeve (mm ²) ¹		0.75 to 25	1.5 to 50	2.5 to 50	2.5 to 95
	Flexible stranded wire without sleeve (mm ²)		0.75 to 25	1.5 to 50	4 to 50	4 to 95
	AWG		18 to 2	16 to 2/0	12 to 2/0	12 to 250MCM
	Solid or stripping length (mm)		15	19.5	26.5	28.5
Bottom-Only Connection	Single stranded wire (mm ²) ¹		0.75 to 25	1.5 to 50	4 to 70	4 to 120
	Flexible stranded wire with sleeve (mm ²) ¹		0.75 to 16	1.5 to 35	2.5 to 50	2.5 to 95
	Flexible stranded wire without sleeve (mm ²)		0.75 to 16	1.5 to 35	4 to 50	4 to 95
	AWG		18 to 3	16 to 1/0	12 to 2/0	12 to 250MCM
	Sheath stripping length (mm)		12.5	16	26.5	28.5
Top/Bottom Connection	Solid or stranded wire (mm ²) ¹	Top/ bottom	0.75 to 25	1.5 to 50	4 to 70	4 to 120
	Flexible stranded wire with sleeve (mm ²) ¹	Top/ bottom	0.75 to 16	1.5 to 35	2.5 to 50	2.5 to 95
	Flexible stranded wire without sleeve (mm ²)	Top/ bottom	0.75 to 16	1.5 to 35	4 to 50	4 to 95
	AWG	Top/ bottom	18 to 3	16 to 1/0	12 to 2/0	12 to 250MCM
Tool		Phillips screwdriver, H-type, No.2 (ISO 8764); ADC part number DN-SP1 or DN-SP2		Hex. wrench 4 (ISO 2936)		
		Flat-blade screwdriver, 1 x 5, 5xL-type, B (ISO 2830); ADC part number DN-SS5				
Tightening Torque (Nm)		2.5	8	10		
Self-locking Torque (Nm) ²		1	2			
<p>Note 1: Stranded wire (0 to 25mm²) consists of 7 wires or less. Stranded wire (35 to 120mm²) consists of 19 wires or less. Flexible stranded wire consists of more number wires than the above.</p>		<p>Note 2: The tightening bolt must be loosened in order to insert the wire. However, stop loosening the bolt when the anti-drop attachment on the bottom of the bolt reaches the top edge of the terminal. If a torque exceeding that given in the table is applied in this state, the retaining bracket may loosen.</p>				

Fuji Duo Series SC-E Contactors

Electrical durability

AC-3 duty / SC-E02 to SC-E05-xxx

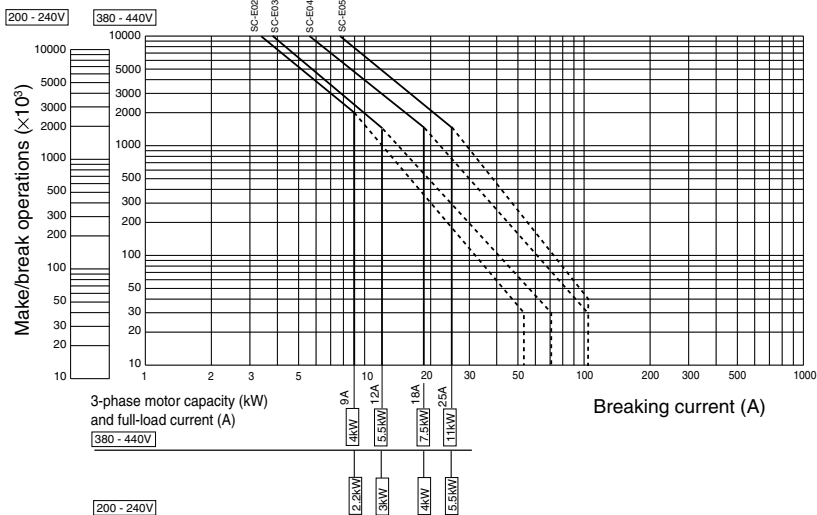

AC-3 duty / SC-E1 to SC-E7-xxx

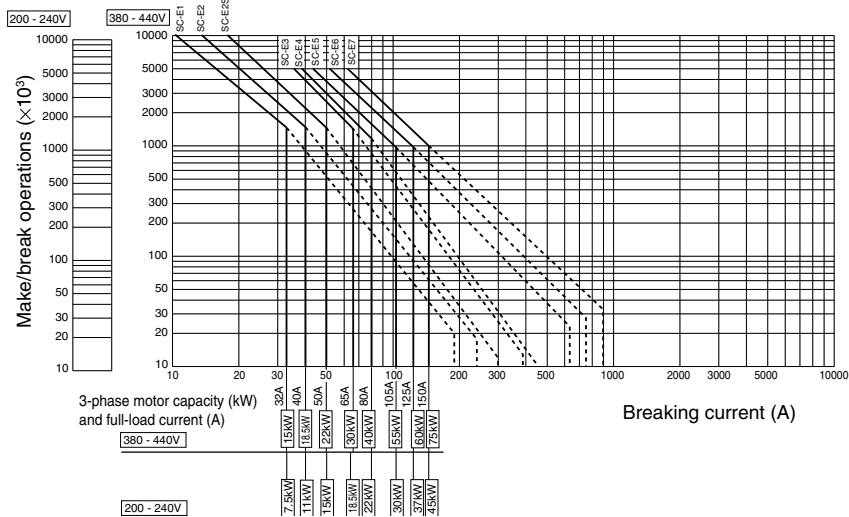

AC-1 duty / SC-E02 to SC-E7-xxx

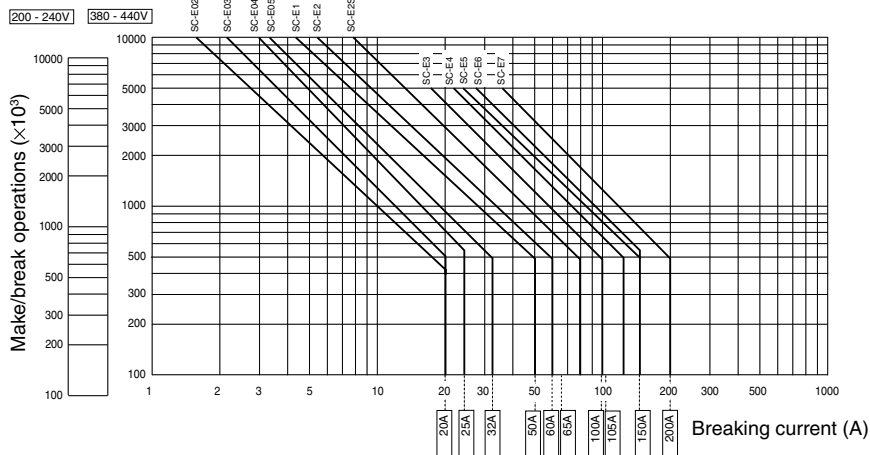

Fuji Duo Series SC-E Contactors

Accessories

Optional accessories

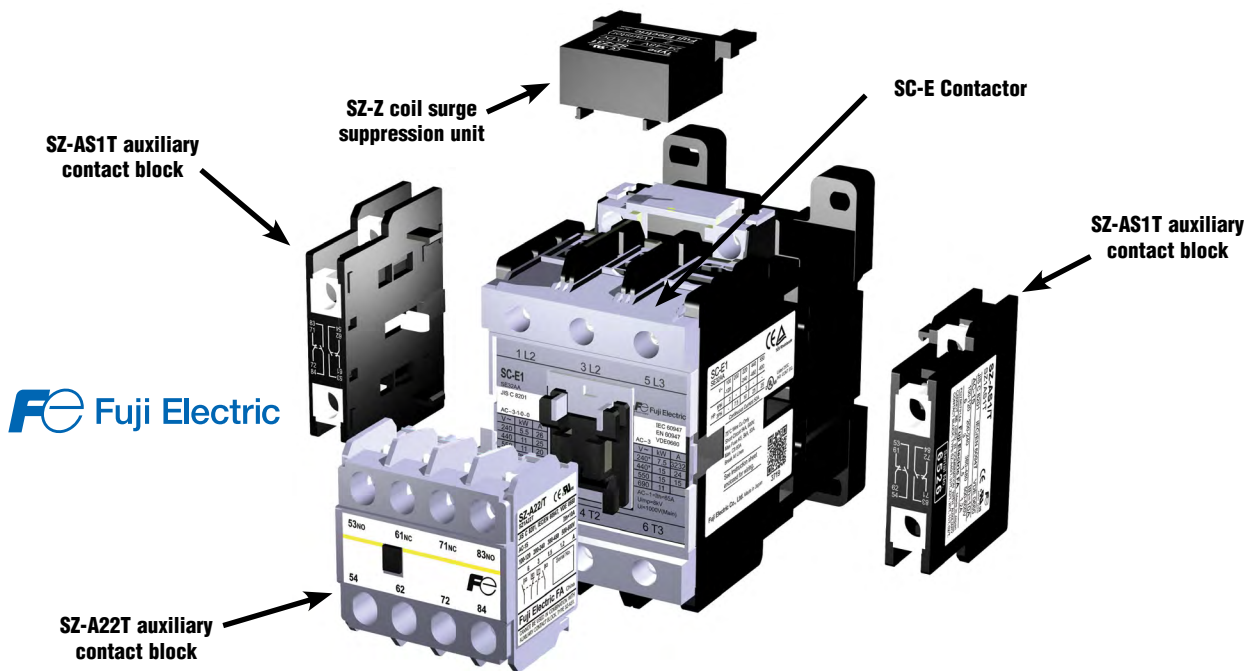

Auxiliary contact blocks with terminal covers

Maximum auxiliary contact blocks: 2 side mounted (1 per side) **OR** 1 front mounted. The front and side blocks cannot be mounted together on the same contactor.



SZ-A22T



SZ-A11T



SZ-AS1T



SZ-AS2T

Caution on use:

1. Front mounting auxiliary contact block and side mounting block cannot be attached to one contactor at the same time.
2. Only one front mounting block can be attached to one contactor.
3. Where interlock unit is already attached, side mounting auxiliary contact block can be attached on one side only.

Auxiliary Contact Blocks with Terminal Covers					
Part Number	Price	Applicable Contactor	Mounting	Number of Contacts	Contact Arrangement
SZ-A22T		SC-E02(G)-xxx to E4(G)-xxx	Front mounting	4	2NO + 2NC
SZ-A20T				2	2NO
SZ-A11T				2	1NO + 1NC
SZ-AS1T		SC-E5, E6, E7-xxx, SC-N4, N5, N6, N7, N8, N10, N11, N12, SC-E5(G)-xxx to E7(G)-xxx	Side mounting	2	1NO + 1NC
SZ-AS2T				2	1NO + 1NC

Accessory Auxiliary Contact Ratings - UL and CSA				
NEMA ICS 5-2000 Ratings (note 1)				
AC Ratings			DC Ratings	
Designation	Making VA	Breaking VA	Designation	Making/Breaking VA
A600	7200	720	Q300	69

For more information, refer to Control Circuit Contact Electrical Ratings, page MRC-111

Accessory Auxiliary Contact Ratings - IEC and JIS continued on next page.

Fuji Duo Series SC-E Contactors Accessories

Accessory Auxiliary Contact Ratings - IEC and JIS							
Rated Thermal Current (A)	Making and Breaking Capacity at AC (A)		Rated operational current (A)				Minimum Operating Voltage and Current
			AC		DC		
			Voltage	AC-15 (Ind. load)	Voltage	DC-13 (Ind. load)	
10	120V	60	120V	6	24V	3	5VDC, 3mA
	220V	30	220V	3	48V	1.5	
	440V	15	440V	1.5	110V	0.55	
	600V	12	600V	1.2	220V	0.27	

Coil surge suppression units



SZ-Z1

SZ-Z37

Suppress surge voltage due to contactor ON-OFF operations; easily connect to contactor coil terminals.

Important: When driving 24VDC Fuji contactors with a PLC solid-state output, we recommend using diode terminal block part number DN-D10DR-A or ZL-TSD8-24. Please see application note AN-MISC-032 for additional information located on Automationdirect.com/technotes.

Coil Surge Suppression Units					
Part Number	Price	Applicable Contactor		Operating Coil Voltage	Device
		AC Operated	DC Operated		
SZ-Z1		SC-E02-xxx to E05-xxx	SC-E02G-xxx to E05G-xxx	24-48V AC/DC	varistor
SZ-Z2				100-250V AC/DC	
SZ-Z31		SC-E1-xxx to -E4xxx	SC-E1G-xxx to E4G-xxx	24-48V AC/DC	
SZ-Z32				100-250V AC/DC	
SZ-Z4		SC-E02-xxx to E05-xxx	SC-E02G-xxx to E05G-xxx	24-48V AC/DC	capacitor / resistor
SZ-Z5				100-250V AC/DC	
SZ-Z34		SC-E1-xxx to E4-xxx	-	24-48V AC/DC	
SZ-Z35				100-250V AC/DC	
SZ-Z36		-	SC-E1G-xxx to E4G-xxx	24-48V AC/DC	
SZ-Z37				100-250V AC/DC	
SC-E02 to E05				380-440V AC/DC	
SC-E1 to E4				380-440V AC/DC	

Note: Super Magnet Coils on SC-E5, SC-E6, and SC-E7 contactors have internal surge suppression. See diagram below.

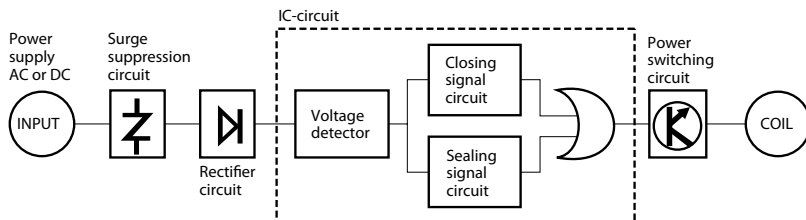

Replacement contactor coils



SZ-GSN5-100

SC-E Series Replacement Contactor Coils			
Part Number	Price	Applicable Contactor	Coil Voltage
SZ-GSN5-100		SC-E5-xxx	100-127VAC 50/60Hz / 100-120VDC
SZ-GSN6-100		SC-E6-xxx, SC-E7-xxx	100-127VAC 50/60Hz / 100-120VDC
SZ-GSN5-200		SC-E5-xxx	200-250VAC 50/60Hz / 200-240VDC
SZ-GSN6-200		SC-E6-xxx, SC-E7-xxx	200-250VAC 50/60Hz / 200-240VDC
SZ-GSN5-24		SC-E5-xxx	24-25VAC/ 50/60Hz / 24VDC
SZ-GSN6-24		SC-E6-xxx, SC-E7-xxx	24-25VAC/ 50/60Hz / 24VDC

Replacement coils are available for contactor sizes SC-E5 and larger only. Replacement coils are not available for coil codes 440VAC, 500VAC, 400V, 500V.

Fuji Duo Series SC-E Accessories

Connection kits for reversing SC-E contactors



SZ-ERW1A



SZ-ERW1B



SZ-ERW1D



SZ-ERW2A



SZ-ERW2B

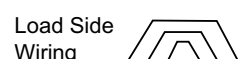
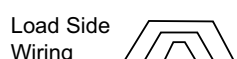
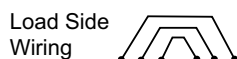

SZ-ERW2D



SZ-ERW3A



SZ-ERW3B



SZ-ERW3D

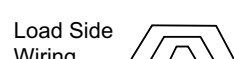
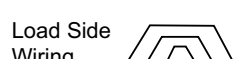
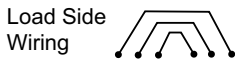

Connection Kits			
Part Number	Price	Description	Use with Contactors
SZ-ERW1A		Line side reversing connection kit.	
SZ-ERW1B*		Load side reversing connection kit. For wiring load side when using contactors only or with a MMS device.	SC-E02-xxx to SC-E05-xxx
SZ-ERW1D		Load side reversing connection kit. For wiring load side when using two contactors with a thermal overload relay.	
SZ-ERW2A		Line side reversing connection kit.	
SZ-ERW2B*		Load side reversing connection kit. For wiring load side when using contactors only or with a MMS device.	SC-E1-xxx to SC-E2S-xxx
SZ-ERW2D		Load side reversing connection kit. For wiring load side when using two contactors with a thermal overload relay.	
SZ-ERW3A		Line side reversing connection kit.	
SZ-ERW3B*		Load side reversing connection kit. For wiring load side when using contactors only or with a MMS device.	SC-E3-xxx to SC-E4-xxx
SZ-ERW3D		Load side reversing connection kit. For wiring load side when using two contactors with a thermal overload relay.	

* When using the SZ-ERWxB, a TK-E thermal overload relay must be separately mounted and wired using an SZ-HxE base. To assemble a TK-E overload directly to the contactor use a SZ-ERWxD load side connection kit.

Mechanical interlock unit



SZ-RM

Mechanical Interlock Unit			
Part Number	Price	Description	Use with Contactors
SZ-RM		Used when building a reversing starter. Prevents both contactors from being pulled in at once.	SC-E02-xxx to SC-E4-xxx

NOTE: Mechanical interlock unit cannot be used with SC-E5-xxx through E7-xxx contactors.

Parts for reversing Fuji SC-E contactors

- SC-E (Contactors - qty. 2)
- SZ-ERWxA (Line side connection kit - qty. 1)
- SZ-ERWxB* (Load side connection kit - qty. 1)
- SZ-RM (Mechanical interlock - qty. 1)
- SZ-AxxT (Auxiliary contact blocks - qty. 1)



Fuji Duo Series SC-E Contactors

Dimensions (mm)

Contactors

SC-E02, E03, E04, E05-xxx

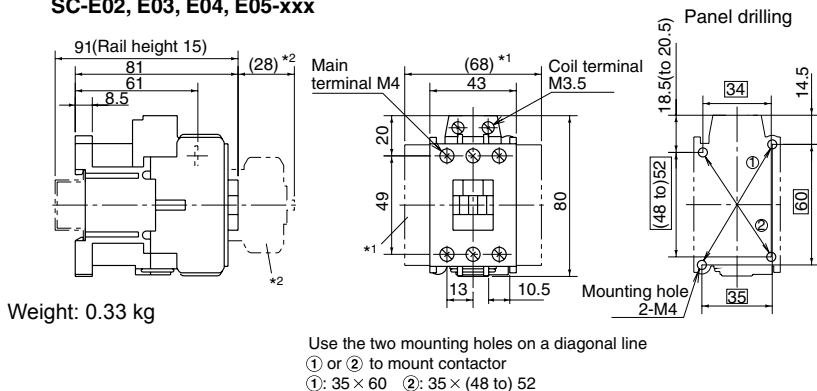

SC-E1, E2, E2S-xxx

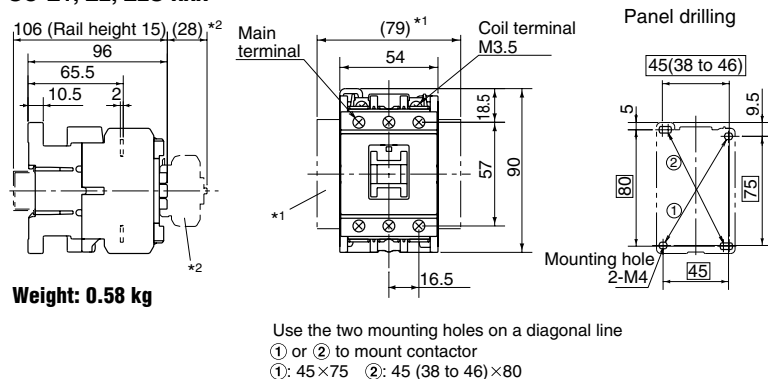

SC-E3, E4-xxx

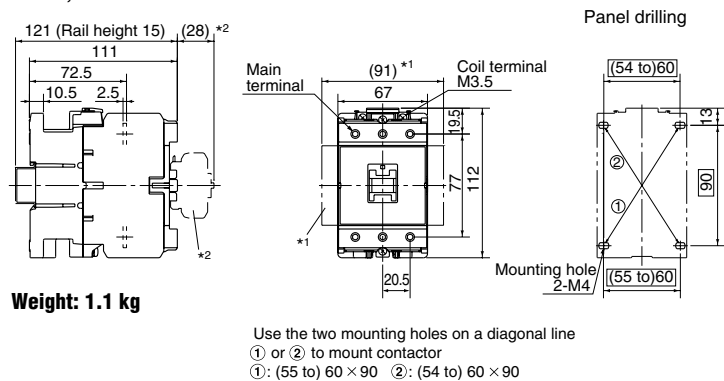

Wiring diagrams

Contactors

SC-E02 to E05-xxx
 SC-E1 to E4-xxx
 SC-E02G to E05G-xxx
 SC-E1G to E4G-xxx
 SC-E2S, E2SG-xxx

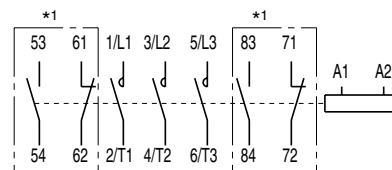

SC-E5, E6, E7-xxx

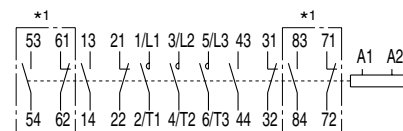

*1 In case of aux. contact 4NO+4NC

Fuji Duo Series SC-E Contactors

Dimensions (mm)

Contactors

SC-E5-xxx

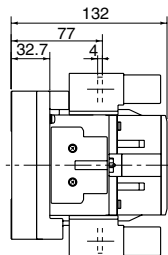

Weight: 2.0 kg

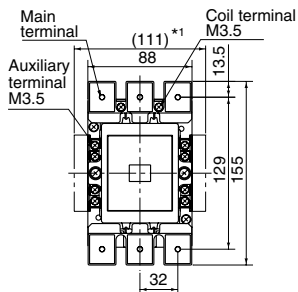

Panel drilling

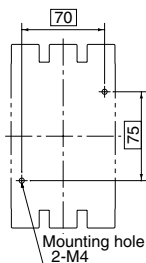

*1 Side mounting aux. contact block
*2 Front mounting aux. contact block

SC-E6-xxx

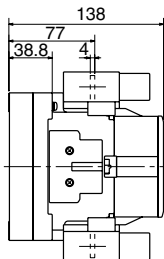

Weight: 2.6 kg

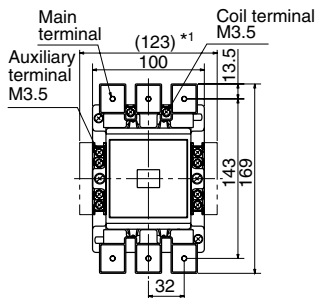

Panel drilling

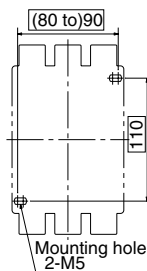

SC-E7-xxx

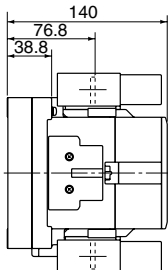

Weight: 2.9 kg

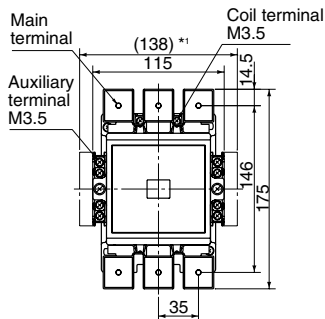

Panel drilling

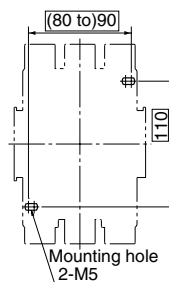

SC-E02G, E03G, E04G, E05G-xxx

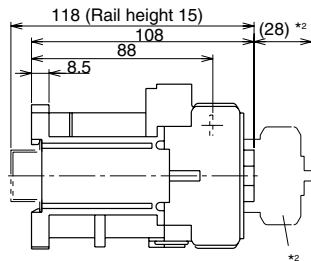

Weight: 0.59 kg

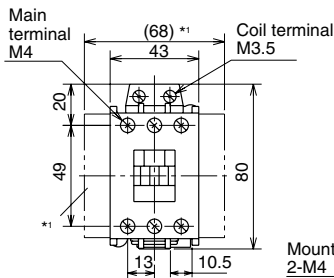

Panel drilling

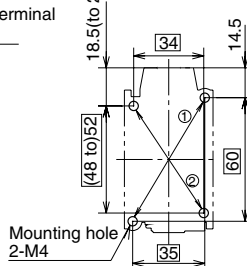

Use the two mounting holes on a diagonal line
① or ② to mount contactor
① 35 × 60 ②: 35 × (48 to 52)

Fuji Duo Series SC-E Contactors

Dimensions (mm)

Contactors

SC-E1G, E2G, E2SG-xxx

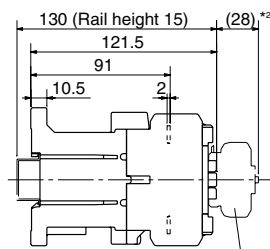

Weight: 0.79 kg

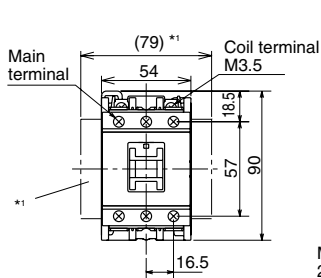

Panel drilling

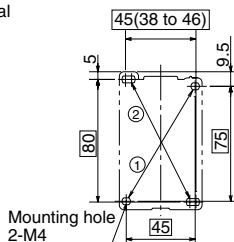

*1 Side mounting aux. contact block
*2 Front mounting aux. contact block

Use the two mounting holes on a diagonal line
① or ② to mount contactor
①: 45×75 ②: 45 (38 to 46)×80

SC-E3G, E4G-xxx

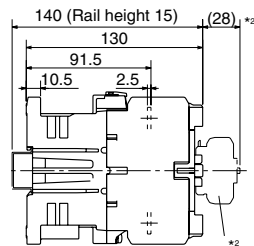

Weight: 1.4 kg

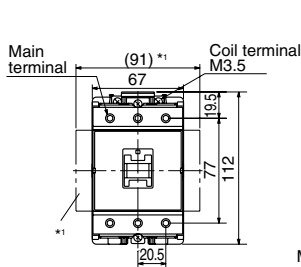

Panel drilling

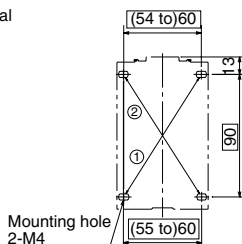

*1 Side mounting aux. contact block
*2 Front mounting aux. contact block

Use the two mounting holes on a diagonal line
① or ② to mount contactor
①: (55 to 60) 60×90 ②: (54 to 60) 60×90

Dimensions-mm

Auxiliary contact blocks - front mounting

SZ-A22T, A20T, A11T for SC-E02 (G)-xxx to E4 (G)-xxx

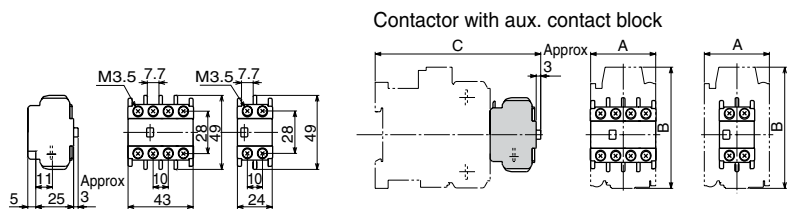

A22T Weight: 36 g
SZ-A20T, A11T Weight: 20 g

Wiring diagrams

SZ-A22T, A20T, A11T

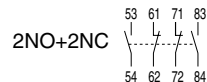
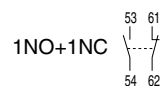
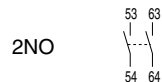

Type	A	B	C
SC-E02, E03, E04, E05-xxx	43	80	109
SC-E1, E2, E2S-xxx	54	90	124
SC-E3, E4-xxx	67	112	139
SC-E02G, E03G, E04G, E05(G)-xxx	43	80	136
SC-E1G, E2G, E2SG-xxx	54	90	149.5
SC-E3G, E4G-xxx	67	112	158

Fuji Duo Series SC-E Contactors

Dimensions (mm)

Auxiliary contact blocks - side mounting

SZ-AS1T for SC-E02(G)-xxx to E4(G)-xxx

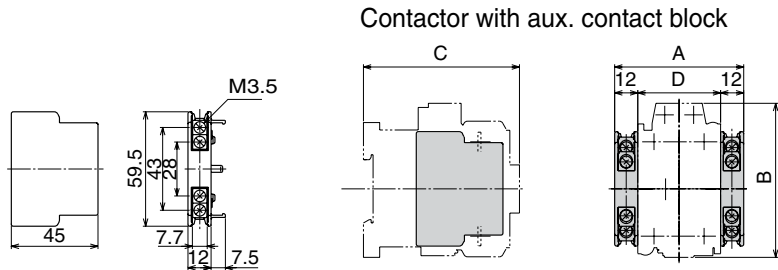

Weight: 28 g

Type	A	B	C	D
SC-E02, E03, E04, E05-xxx	67	80	81	43
SC-E1, E2, E2S-xxx	78	90	54	54
SC-E3, E4-xxx	91	112	67	67
SC-E02G, E03G, E04G, E05(G)-xxx	67	80	108	43
SC-E1G, E2G, E2SG-xxx	78	90	121.5	54
SC-E3G, E4G-xxx	91	112	130	67

Wiring diagrams

1 N.O. + 1 N.C.

Mounted on right side

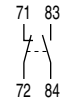

Mounted on left side



SZ-AS2T for SC-E5 to E7-xxx

Contactor with aux. contact block

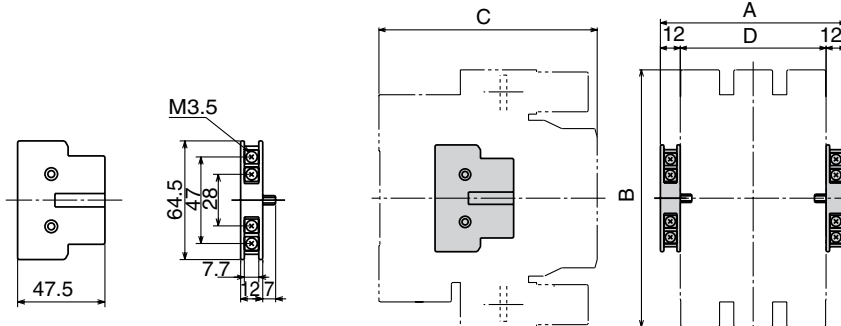

Weight: 40 g

Type	A	B	C	D
SC-E5-xxx	112	155	132	88
SC-E6-xxx	124	169	138	100
SC-E7-xxx	139	175	140	115

1 N.O. + 1 N.C.

Mounted on right side



Mounted on left side



Fuji Duo Series SC-E Contactors

Dimensions (mm)

Coil surge suppression units

SZ-Z1, Z2, Z4, Z5

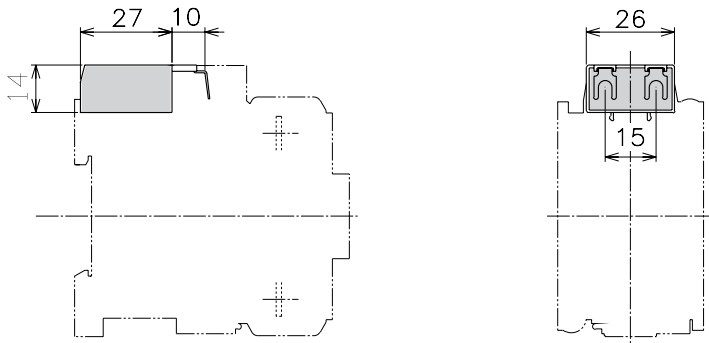

Weight: 14 g

SZ-Z31, Z32, Z34, Z35, Z36, Z36, Z37

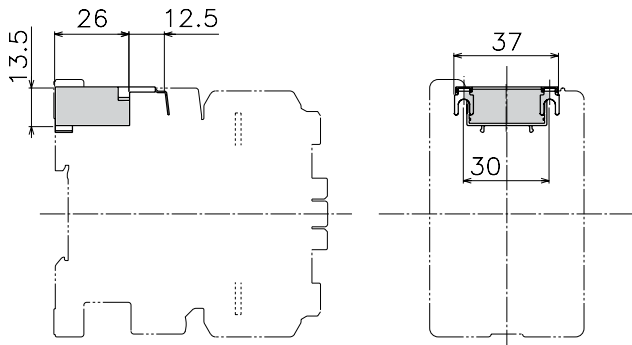

Weight: 15 g

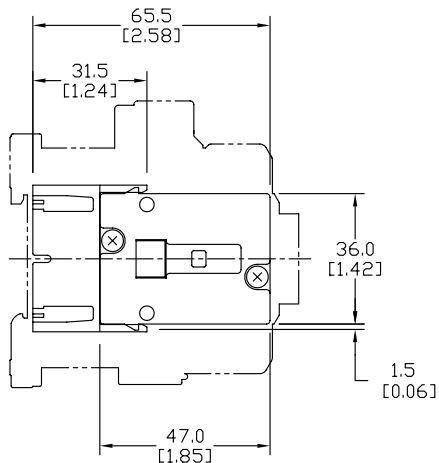

SZ-RM

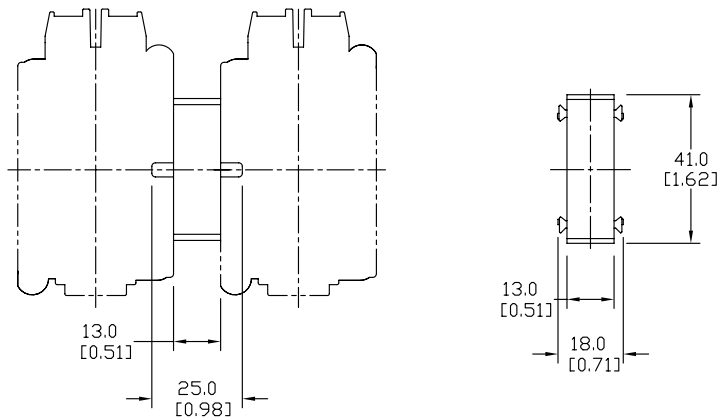

Wiring diagrams

SC-E02 to E05-xxx + SZ-Z1, Z2 (Built-in varistor)

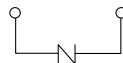

SC-E02 to E05-xxx + SZ-Z4, Z5 (Built-in capacitor/resistor)

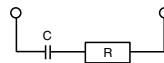

SC-E1 to E4-xxx + SZ-Z31, Z32 (Built-in varistor)

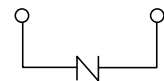

SC-E1 to E4-xxx + SZ-Z34, Z35 (Built-in capacitor/resistor)

SC-E1G to E4G-xxx + SZ-Z36, Z37 (Built-in capacitor/resistor)

