



# Pneumatic GVP Series Miniature Latching Solenoid Valves



Part No. GVP-311CL-24D



Part No. GVP-321CL-12D

Diagram "A"

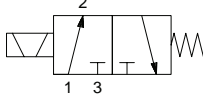

3-way, 2-position, Spring Return

NITRA pneumatic latching solenoid valves will stay open after being momentarily energized thus saving power consumption and reducing heat. Valves must be mounted to a GM-3 series manifold (sold separately).

## Features

- 10mm and 15mm valve widths
- 3-way normally closed configuration
- Reversing polarity changes state
- GM-3 series manifolds sold separately



See for a wide variety of fitting options

GVP Series Miniature Latching Solenoid Valves		
Model	GVP-311CL-24D	GVP-321CL-12D
Price		
Weight (lbs)	0.05	0.1
Size	10mm	15mm
Valve Type	3-way, 2-position, Normally Closed	3-way, 2-position, Normally Closed
Acting	Single latching solenoid spring return poppet	
Diagram	A	A
Fluid	Air or Inert Gas (to be filtered by 40µ filter element)	
Min. / Max. Pressure	0 to 105 psi (0 to 7.24 bar)	
Flow (Cv)	0.013	0.047
Port	Requires GM type 10mm or 15mm manifolds for operation	
Voltage	24VDC	12VDC
Continuous ON Power	1.3 W	1.6 W
Expected Life	50,000,000 cycles at max 2 cycles/second	
Wiring	Connector Receptacle (Wire connector required)	18" Flying Leads
Response Time	6ms (on), 8ms (off)	
Indication	LED	
Temperature - Operation and Storage	14-122°F (-10-50°C)	
Lubrication	Not Required	
Body	Glass-filled nylon	
Protection	n/a	



# Pneumatic GVP Series Miniature Latching Solenoid Valves

## Dimensions

mm [inches]

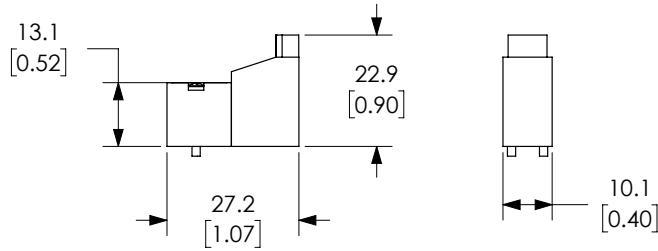

**GVP-x11CL-xxD**

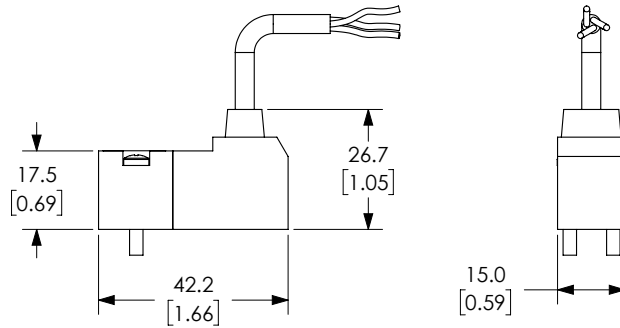

**GPV-x21CL-xxD**

See our website [for complete Engineering drawings.](#)







# Pneumatic GVP Series Miniature Solenoid Valve Manifolds



NITRA manifolds designed to work with 10mm wide GVP series valves.

- Single to 6 stations
- #10-32 female threaded ports
- Precision machined
- Compact
- Anodized aluminum for corrosion resistance
- Made in USA



Nitra Pneumatic GVP Series 10mm Miniature Solenoid Valve Manifolds					
Item	Part No.	Description	A inches [mm]	Price	Weight (lbs)
	<b>GM-311</b>	NITRA pneumatic valve manifold, anodized aluminum, rectangular, (1) station, #10-32 female threaded inlet(s), #10-32 female threaded outlet(s), #10-32 female threaded exhaust(s). For use with GVP-21 and GVP-31 series solenoid valves.	N/A		0.05
	<b>GM-312</b>	NITRA pneumatic valve manifold, anodized aluminum, rectangular, (2) stations, #10-32 female threaded inlet(s), #10-32 female threaded outlet(s), #10-32 female threaded exhaust(s). For use with GVP-21 and GVP-31 series solenoid valves.	1.42 [36.1]		0.05
	<b>GM-314</b>	NITRA pneumatic valve manifold, anodized aluminum, rectangular, (4) stations, #10-32 female threaded inlet(s), #10-32 female threaded outlet(s), #10-32 female threaded exhaust(s). For use with GVP-21 and GVP-31 series solenoid valves.	2.25 [78.2]		0.10
	<b>GM-316</b>	NITRA pneumatic valve manifold, anodized aluminum, rectangular, (6) stations, #10-32 female threaded inlet(s), #10-32 female threaded outlet(s), #10-32 female threaded exhaust(s). For use with GVP-21 and GVP-31 series solenoid valves.	3.08 [78.2]		0.15

## Assembly Example

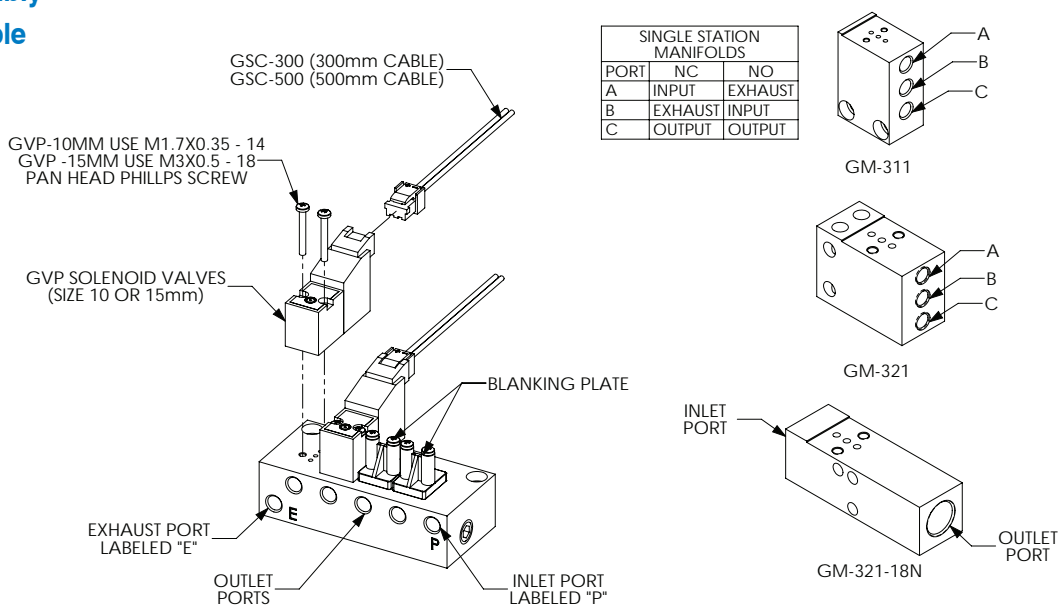







# Pneumatic GVP Series Miniature Solenoid Valve Manifolds



NITRA manifolds designed to work with 15mm wide GVP series valves.

- Single to 4 stations
- #10-32 threaded or 1/8in NPT female ports
- Precision machined
- Compact
- Anodized aluminum for corrosion resistance
- Made in USA



Nitra Pneumatic GVP Series 15mm Miniature Solenoid Valve Manifolds					
Item	Part No.	Description	A inches [mm]	Price	Weight (lbs)
	<b>GM-321</b>	NITRA pneumatic valve manifold, anodized aluminum, rectangular, (1) station, #10-32 female threaded inlet(s), #10-32 female threaded outlet(s), #10-32 female threaded exhaust(s). For use with GVP-22 and GVP-32 series solenoid valves.	N/A		0.05
	<b>GM-322</b>	NITRA pneumatic valve manifold, anodized aluminum, rectangular, (2) stations, 1/8in female NPT inlet(s), #10-32 female threaded outlet(s), 1/8in female NPT exhaust(s). For use with GVP-22 and GVP-32 series solenoid valves.	2.13 [54.0]		0.15
	<b>GM-324</b>	NITRA pneumatic valve manifold, anodized aluminum, rectangular, (4) stations, 1/8in female NPT inlet(s), #10-32 female threaded outlet(s), 1/8in female NPT exhaust(s). For use with GVP-22 and GVP-32 series solenoid valves.	3.37 [85.7]		0.25
	<b>GM-321-18N</b>	NITRA pneumatic valve manifold, anodized aluminum, rectangular, (1) station, 1/8in female NPT inlet(s), 1/8in female NPT outlet(s), vent hole exhaust(s). For use with GVP-22 and GVP-32 series solenoid valves.	N/A		0.6

## Assembly Example

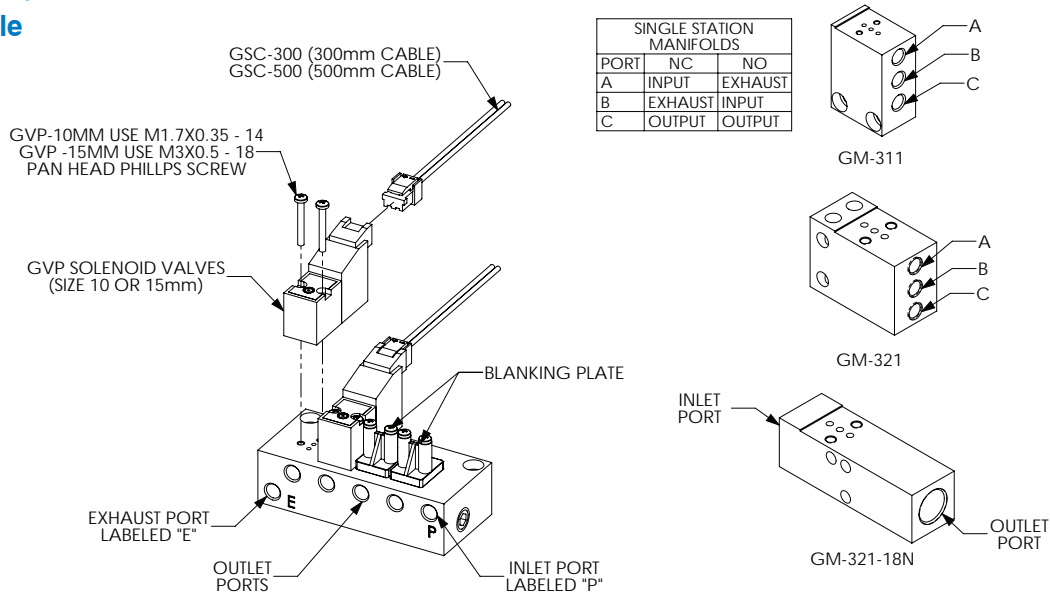



# Pneumatic GVP Series Miniature Solenoid Valve Manifolds

## Dimensions

mm [inches]

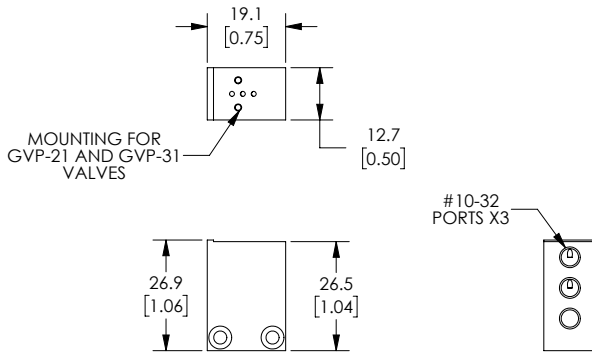

**Part No. GM-311**

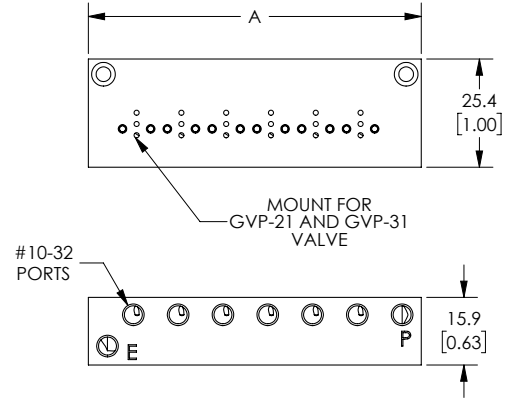

**Part No. GM-312, GM-314, GM-316**

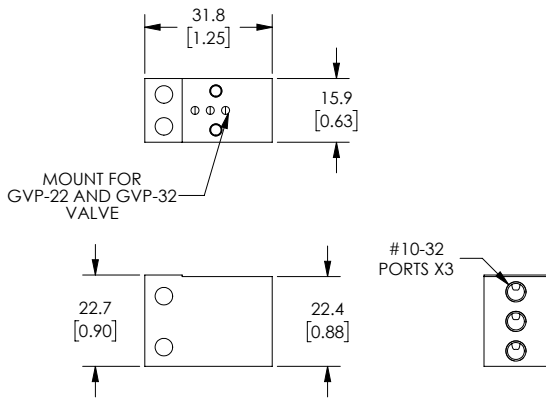

**Part No. GM-321**

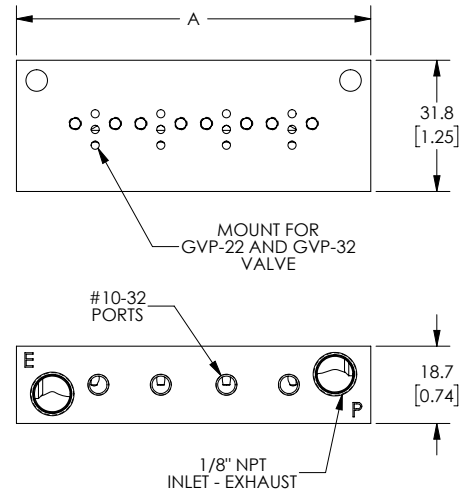

**Part No. GM-322, GM-324**

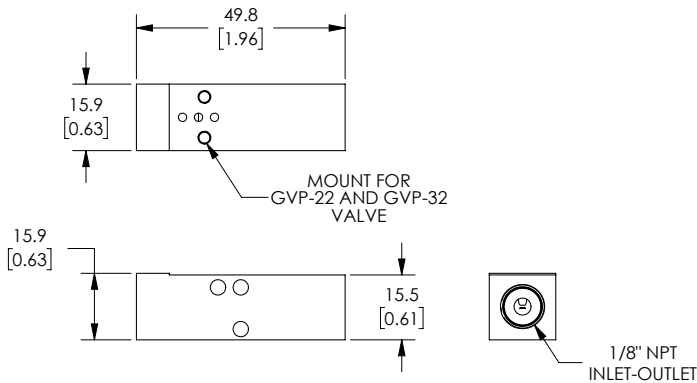





**Part No. GM-321-18N**

See our website for complete Engineering drawings.



# Pneumatic GVP Series Miniature Solenoid Manifold Accessories



Nitra Pneumatic GVP Series Miniature Solenoid Valve Manifold Accessories				
Item	Part No.	Description	Price	Weight (lbs)
	<b>GM-31BP</b>	NITRA blanking plate, nylon. For use with GM-31 series manifolds. Gasket and mounting screws included.		0.05
	<b>GM-32BP</b>	NITRA blanking plate, nylon. For use with GM-32 series manifolds. Gasket and mounting screws included.		0.05
	<b>GSC-300</b>	NITRA solenoid valve cable, miniature pin plug to pigtail, 11.8in/300mm cable length. For use with GVP series solenoid valves.		0.05
	<b>GSC-500</b>	NITRA solenoid valve cable, miniature pin plug to pigtail, 19.6in/500mm cable length. For use with GVP series solenoid valves.		0.05

## Dimensions

mm [inches]

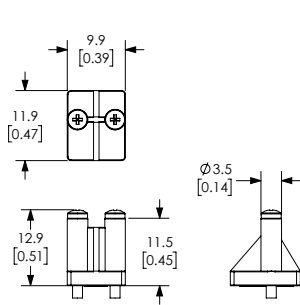

Part No. GM-31BP

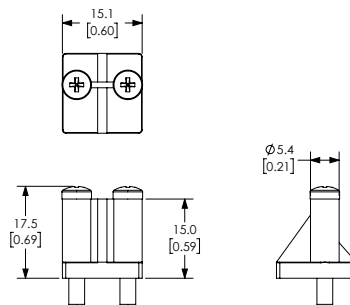

Part No. GM-32BP

See our website for complete Engineering drawings.