







# Pneumatic GVP Series Miniature Solenoid Valve Manifolds



NITRA manifolds designed to work with 15mm wide GVP series valves.

- Single to 4 stations
- #10-32 threaded or 1/8in NPT female ports
- Precision machined
- Compact
- Anodized aluminum for corrosion resistance
- Made in USA



Nitra Pneumatic GVP Series 15mm Miniature Solenoid Valve Manifolds						
Item	Part No.	Description	A inches [mm]	Price	Weight (lbs)	
	<b>GM-321</b>	NITRA pneumatic valve manifold, anodized aluminum, rectangular, (1) station, #10-32 female threaded inlet(s), #10-32 female threaded outlet(s), #10-32 female threaded exhaust(s). For use with GVP-22 and GVP-32 series solenoid valves.	N/A		0.05	
	<b>GM-322</b>	NITRA pneumatic valve manifold, anodized aluminum, rectangular, (2) stations, 1/8in female NPT inlet(s), #10-32 female threaded outlet(s), 1/8in female NPT exhaust(s). For use with GVP-22 and GVP-32 series solenoid valves.	2.13 [54.0]		0.15	
	<b>GM-324</b>	NITRA pneumatic valve manifold, anodized aluminum, rectangular, (4) stations, 1/8in female NPT inlet(s), #10-32 female threaded outlet(s), 1/8in female NPT exhaust(s). For use with GVP-22 and GVP-32 series solenoid valves.	3.37 [85.7]		0.25	
	<b>GM-321-18N</b>	NITRA pneumatic valve manifold, anodized aluminum, rectangular, (1) station, 1/8in female NPT inlet(s), 1/8in female NPT outlet(s), vent hole exhaust(s). For use with GVP-22 and GVP-32 series solenoid valves.	N/A		0.6	

## Assembly Example

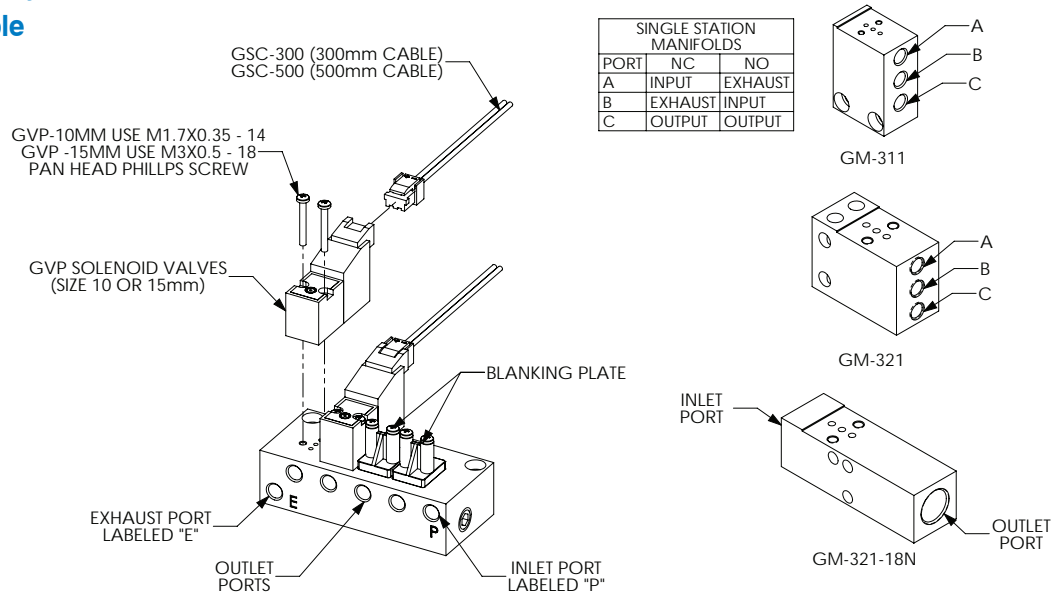



# Pneumatic GVP Series Miniature Solenoid Valve Manifolds

## Dimensions

mm [inches]

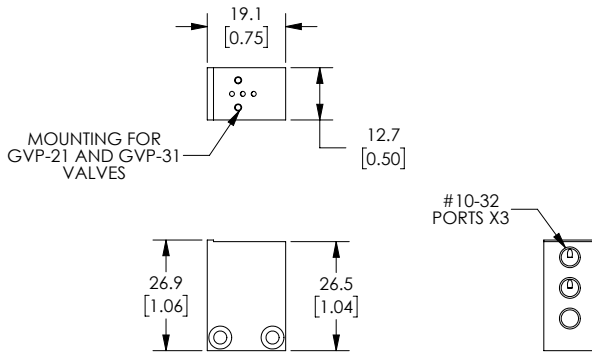

**Part No. GM-311**

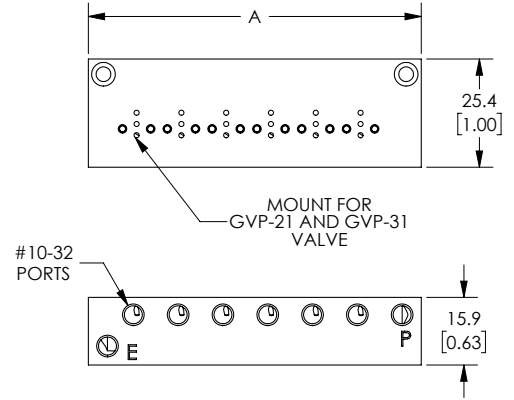

**Part No. GM-312, GM-314, GM-316**

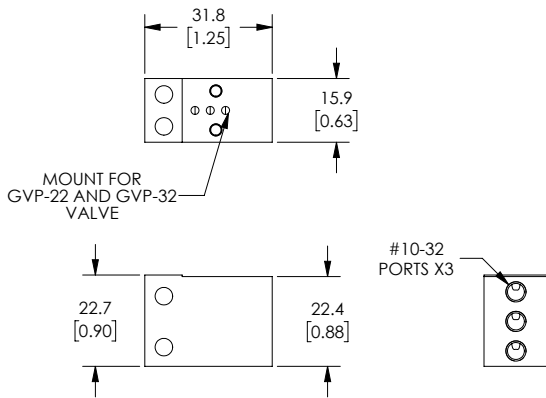

**Part No. GM-321**

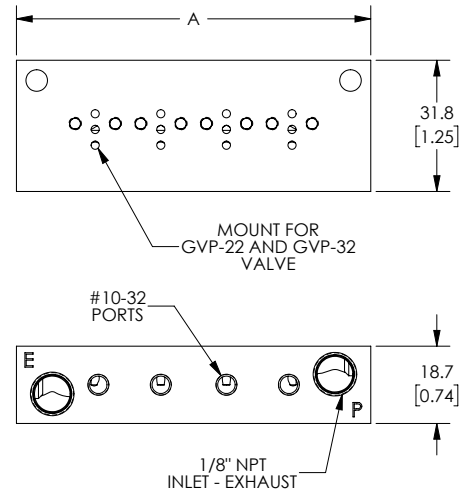

**Part No. GM-322, GM-324**

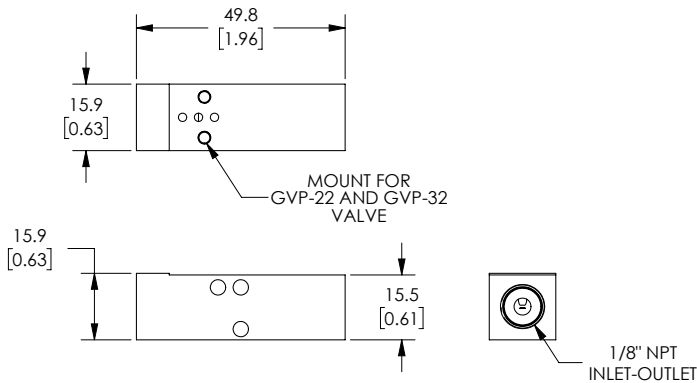





**Part No. GM-321-18N**

See our website for complete Engineering drawings.



# Pneumatic GVP Series Miniature Solenoid Manifold Accessories



Nitra Pneumatic GVP Series Miniature Solenoid Valve Manifold Accessories				
Item	Part No.	Description	Price	Weight (lbs)
	<b>GM-31BP</b>	NITRA blanking plate, nylon. For use with GM-31 series manifolds. Gasket and mounting screws included.		0.05
	<b>GM-32BP</b>	NITRA blanking plate, nylon. For use with GM-32 series manifolds. Gasket and mounting screws included.		0.05
	<b>GSC-300</b>	NITRA solenoid valve cable, miniature pin plug to pigtail, 11.8in/300mm cable length. For use with GVP series solenoid valves.		0.05
	<b>GSC-500</b>	NITRA solenoid valve cable, miniature pin plug to pigtail, 19.6in/500mm cable length. For use with GVP series solenoid valves.		0.05

## Dimensions

mm [inches]

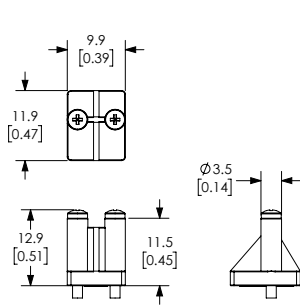

Part No. GM-31BP

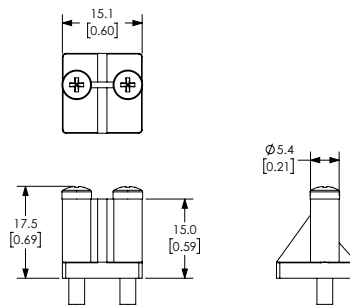

Part No. GM-32BP

See our website for complete Engineering drawings.