

3P Series Molded Case Circuit Breakers Overview

Overview

Designed to provide branch and feeder circuit protection in industrial control panels, this line of Molded Case Circuit Breakers supplies protection against overload in conductors and short circuit in connected equipment such as motors. They are UL listed for installation in UL 508 control panels. Their small size, in relation to standard circuit breakers or other comparable devices, saves panel space. Four frame sizes and all standard accessories are available.

Features

- UL489 listed performance for branch circuit overcurrent protection and disconnecting means
- Patented contact conductor designs featuring high-speed “blow-open” action, providing superior performance when high level fault currents produce extra-ordinary electromechanical forces
- Advanced arc extinguishing technology
- Toggle handle provides three positions (on/off/tripped) along with visual indicators
- Manufactured in ISO 9000 certified facilities
- HACR (heating, air conditioning and refrigeration) rated
- G-Frame and F-Frame breakers are suitable for reverse feed
- K-Frame and L-Frame breakers include 3-pole adjustable magnetic trip.

Listings

- UL 489 MCCB, File: E7819
- Field-installed accessories: UL file E64983
- CSA 22.2 No.5, File: 43556
- IEC 157-1
- NEMA Standards Pub. No. AB1-1993



Manufactured by Eaton Corporation

Note: These parts available for sale to North American locations only.

Molded Case Circuit Breakers Technical Specifications

Circuit Breaker Type	Ampere Rating at 40°C	No. Poles	Volts		Type of Trip*	Federal Specification W-C-375b	UL 489 Interrupting Ratings (rms Symmetrical Amperes) (kA)			
			AC	DC			Volts AC (50/60 Hz)			Volts DC
							240	480	600	
G-Frame	15 -100	3	480	250	N.I.T.U	13b	65	22	–	10
F-Frame	60 - 225	3	600	250	N.I.T.U	22a	65	35	18	10
K-Frame	250 - 400	3	600	250	I.T.U	23a	65	35	25	10
L-Frame	400 - 600	3	600	250	I.T.U	23a	65	35	25	22

*Note: N.I.T.U denotes non-interchangeable trip unit. I.T.U denotes interchangeable trip unit.

**Note: For DC or 1-phase AC applications, use the two outside poles of the 3-pole circuit breaker

Molded Case Circuit Breakers Part Numbering System

G 3P - 020 - AUX

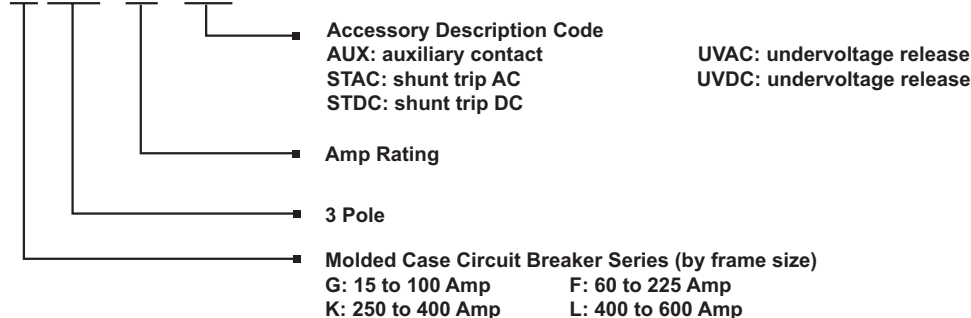

3P Series Molded Case Circuit Breakers 250-400 Amp K-Frame

K-Frame circuit breakers are available as individual components or in a kit. Breaker frame includes 3-pole adjustable magnetic trip. Available

accessories are field installable on this frame size. All breakers include base mounting hardware for panel mount applications.



K3P-400

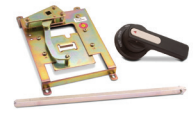

KHMVD12B

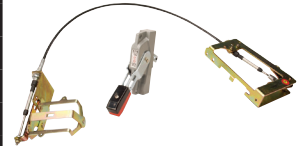

F3S03C

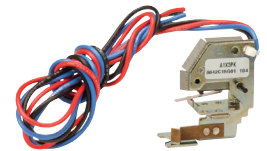

A1X3PK



SNT3P04K

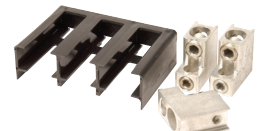

3TA401K

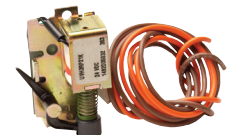

UVH3LP08K

K-Frame Series Three Pole Molded Case Circuit Breakers						
Part Number	Price	Description	Kits	Ampere Rating	Voltage	Interrupt Capacity
K3P-250	1.00	Molded case circuit breaker with adjustable thermal magnetic trip; line and load lug terminals included.	MCCB only	250	240VAC 480VAC 600VAC 250VDC	65kA 35kA 25kA 10kA*
K3P-250-AUX	6.00		Kit includes K3P-250 and A1X3PK			
K3P-250-STAC	1.00		Kit includes K3P-250 and SNT3P11K			
K3P-250-STDC	1.00		Kit includes K3P-250 and SNT3P04K			
K3P-250-UVAC	1.00		Kit includes K3P-250 and UVH3LP08K			
K3P-250-UVDC	1.00		Kit includes K3P-250 and UVH3LP21K			
K3P-300	1.00	Molded case circuit breaker with adjustable thermal magnetic trip; line and load lug terminals included.	MCCB only	300	240VAC 480VAC 600VAC 250VDC	65kA 35kA 25kA 10kA*
K3P-300-AUX	7.00		Kit includes K3P-300 and A1X3PK			
K3P-300-STAC	1.00		Kit includes K3P-300 and SNT3P11K			
K3P-300-STDC	1.00		Kit includes K3P-300 and SNT3P04K			
K3P-300-UVAC	1.00		Kit includes K3P-300 and UVH3LP08K			
K3P-300-UVDC	1.00		Kit includes K3P-300 and UVH3LP21K			
K3P-350	1.00	Molded case circuit breaker with adjustable thermal magnetic trip; line and load lug terminals included.	MCCB only	350	240VAC 480VAC 600VAC 250VDC	65kA 35kA 25kA 10kA*
K3P-350-AUX	7.00		Kit includes K3P-350 and A1X3PK			
K3P-350-STAC	1.00		Kit includes K3P-350 and SNT3P11K			
K3P-350-STDC	1.00		Kit includes K3P-350 and SNT3P04K			
K3P-350-UVAC	1.00		Kit includes K3P-350 and UVH3LP08K			
K3P-350-UVDC	1.00		Kit includes K3P-350 and UVH3LP21K			
K3P-400	1.00	Molded case circuit breaker with adjustable thermal magnetic trip; line and load lug terminals included.	MCCB only	400	240VAC 480VAC 600VAC 250VDC	65kA 35kA 25kA 10kA*
K3P-400-AUX	7.00		Kit includes K3P-400 and A1X3PK			
K3P-400-STAC	1.00		Kit includes K3P-400 and SNT3P11K			
K3P-400-STDC	1.00		Kit includes K3P-400 and SNT3P04K			
K3P-400-UVAC	1.00		Kit includes K3P-400 and UVH3LP08K			
K3P-400-UVDC	1.00		Kit includes K3P-400 and UVH3LP21K			

*Note: For DC or 1-phase AC applications, use the two outside poles of the 3-pole circuit breaker

K-Frame Accessory Selection Guide		
Part Number	Price	Description
KHMVD12B		NEMA 1/12 rotary handle for K-Frame.. Position indicating. Lock-off feature. Shaft length: 12"
HM3R12X		NEMA 4/4X rotary handle for K-Frame.. Position indicating. Lock-off feature. Shaft length: 12"
HM3R24X		NEMA 4/4X rotary handle for K-Frame.. Position indicating. Lock-off feature. Shaft length: 24"
F3S03C		NEMA 1/12 flexible shaft cable operator for K-Frame. Flange Mounted. Lockable. Cable length: 3'
F3S06C		NEMA 1/12 flexible shaft cable operator for K-Frame. Flange Mounted. Lockable. Cable length: 6'
A1X3PK		Field installable auxiliary contact for K-Frame MCCB, SPDT, 18" pigtail leads
SNT3P11K		Field installable 110 - 240 VAC / 110 - 125 VDC shunt trip for K-Frame, 18" pigtail leads
SNT3P04K		Field installable 12/24 VDC / VAC shunt trip for K-Frame, 18" pigtail leads
3TA401K		Replacement lug kit for K-Frame. Package of 3
UVH3LP08K		Field installable 110 - 127 VAC undervoltage release for K-Frame, 18" pigtail leads
UVH3LP21K		Field installable 24 VDC undervoltage release for K-Frame, 18" pigtail leads

Note: See 3P Series Molded Case Circuit Breakers Accessories catalog pages for accessory electrical specifications.

AWG Wire Range Specifications				
Circuit Breaker	Ampere Rating	Wire Type	AWG Wire Range	Metric Wire Range mm ²
K-Frame	250 - 350	Cu/Al	250 - 500 (1)	120 - 240
	400		3/0 - 250 (2)	95 - 120

3P Series Molded Case Circuit Breakers 250-400 Amp K-Frame

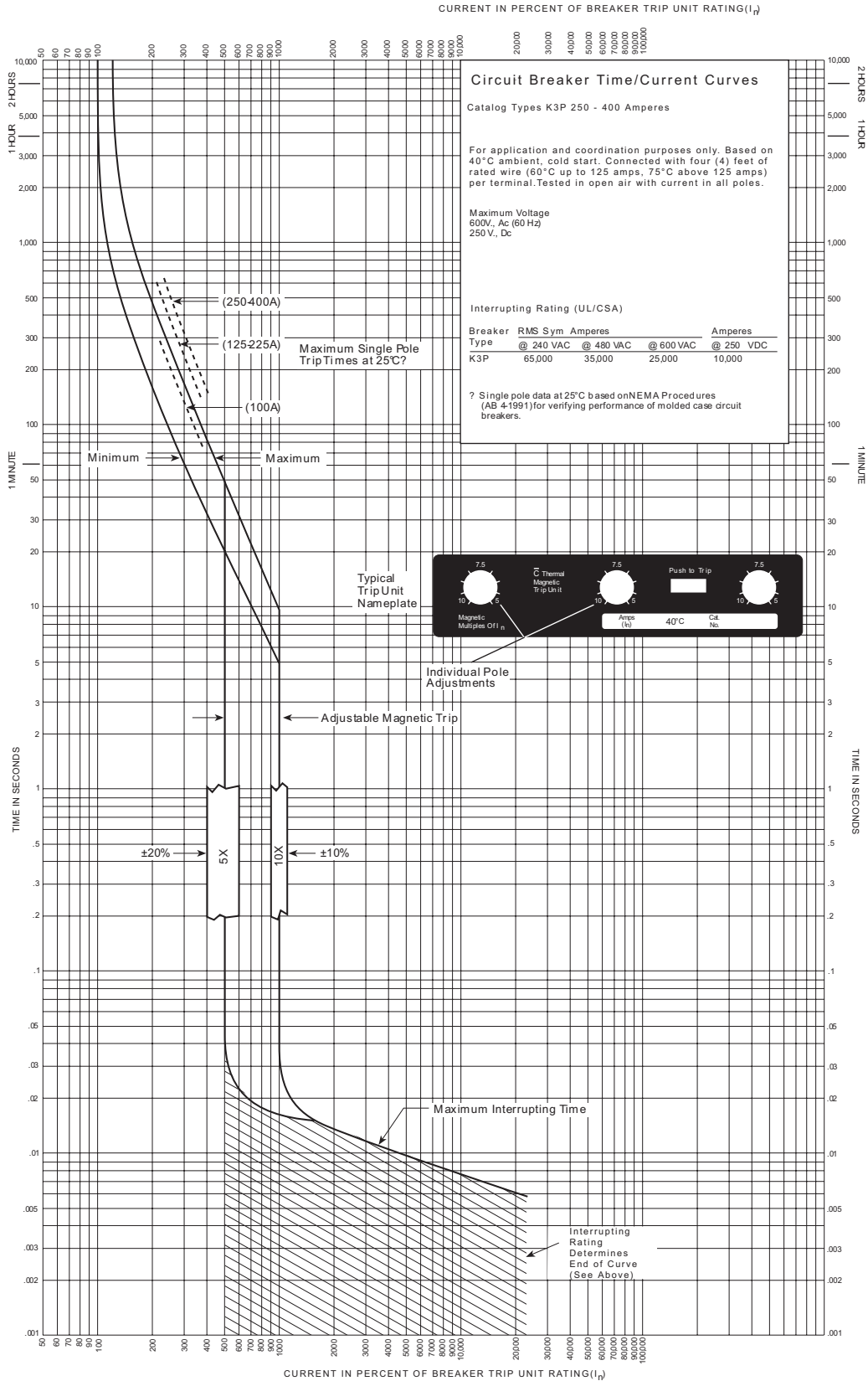

3P Series Molded Case Circuit Breakers

Dimensions

Dimensions

mm [inches]

250 - 400 Amp K-Frame

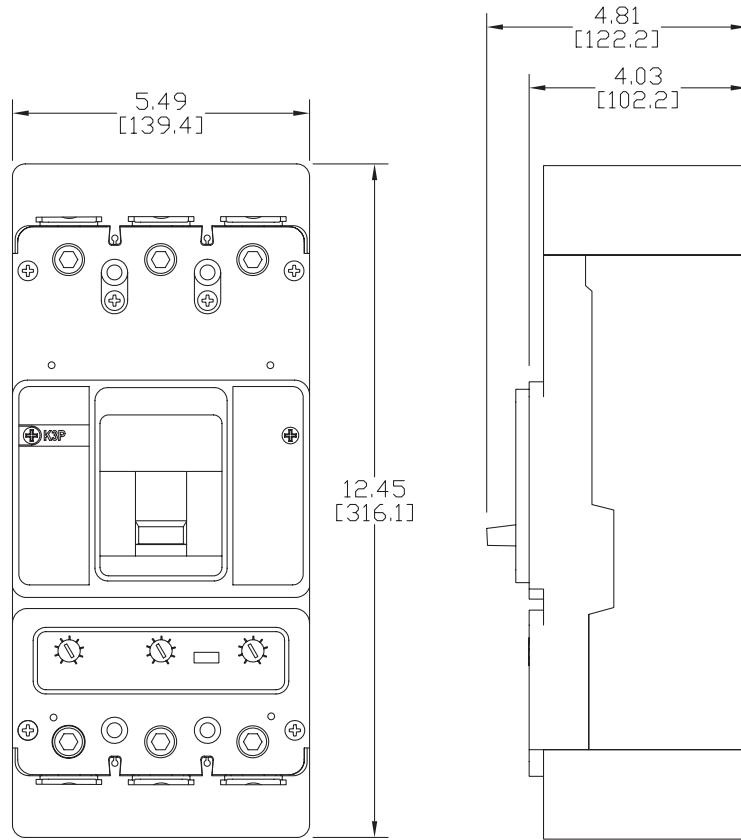

400 - 600 Amp L-Frame

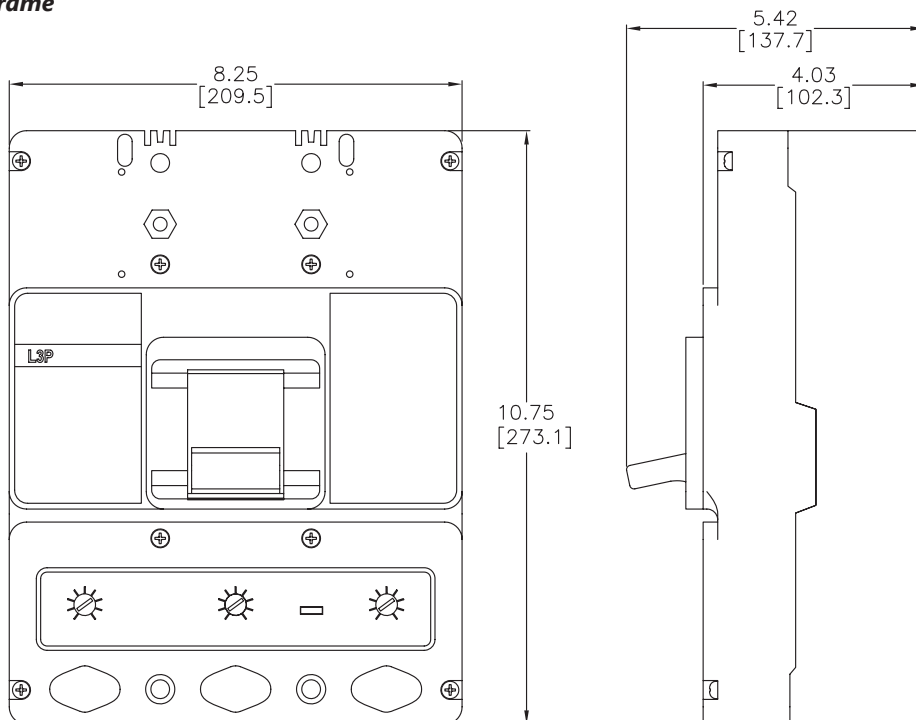

3P Series Molded Case Circuit Breakers

Accessories

Field Mountable Accessories



GHMVD12B

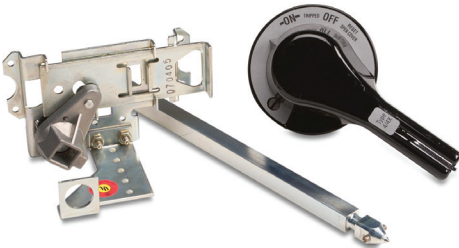

HM1R12X

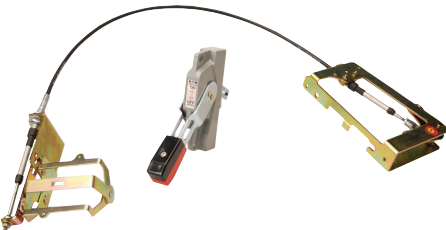

F0S03C

Rotary Handles

A rotary handle is available for each frame size of molded case circuit breaker.

The C-Series rotary handle (HM) is available for F, K, & L frame molded case breakers. These robust and durable handles include the following features:

- Suitable for use with NEMA 4/4X enclosures
- Handle, shaft, and mechanism made from all metal parts
- Large handle easily accommodates gloves
- Heavy Duty Metal locking hasp
- Door interlock and defeater
- Standard ON/OFF/Trip markings and a 45-degree rotation
- UL 489, CSA

The Universal rotary series handles (HMV) is available for G, F, K, & L frame molded case breakers. These handles include the following features:

- Suitable for use with NEMA 1/12 enclosures
- Composite Nylon handle with metal shaft, and mechanism
- Large handle easily accommodates gloves
- Access Handle Lock-Off by pressing arrow on handle insert
- Door interlock and defeater
- Global ON/OFF markings (I/ON, O/OFF) and TRIP indication on handle plus 90-degree rotation
- UL 489, IEC 947-1/-2, CSA

Rotary Handle Accessory Selection Guide

Part Number	Price	Description
GHMVD06B		NEMA 1/12 black rotary handle for G-Frame MCCB. Shaft length: 6in [152.4 mm]
GHMVD12B		NEMA 1/12 black rotary handle for G-Frame MCCB. Shaft length: 12in [304.8 mm]
FHMVD12B		NEMA 1/12 black rotary handle for F-Frame MCCB. Shaft length: 12in [304.8 mm]
HM1R12X		NEMA 4/4X black rotary handle for F-Frame MCCB. Shaft length: 12in [304.8 mm]
HM1R24X		NEMA 4/4X black rotary handle for F-Frame MCCB. Shaft length: 24in [609.6 mm]
KHMVD12B		NEMA 1/12 black rotary handle for K-Frame MCCB. Shaft length: 12in [304.8 mm]
HM3R12X		NEMA 4/4X black rotary handle for K-Frame MCCB. Shaft length: 12in [304.8 mm]
HM3R24X		NEMA 4/4X black rotary handle for K-Frame MCCB. Shaft length: 24in [609.6 mm]
LHMVD12B		NEMA 1/12 black rotary handle for L-Frame MCCB. Shaft length: 12in [304.8 mm]
HM4R12X		NEMA 4/4X black rotary handle for L-Frame MCCB. Shaft length: 12in [304.8 mm]
HM4R24X		NEMA 4/4X black rotary handle for L-Frame MCCB. Shaft length: 24in [609.6 mm]

Flex Shaft™ Flexible Handle

Meeting crucial time limits for shutdown procedures is easier with an externally mounted handle. The flexible handle makes it possible to operate the circuit breaker externally and can be used in enclosures of varying depths and heights. It can be used with NEMA 1, NEMA 3R and NEMA 12 enclosures, and it accepts up to three padlock shackles. Each item includes a painted steel handle, breaker operating mechanism, and cable.

Note: A minimum bending radius of four inches is necessary for proper operation.

Flex Shaft™ Flexible Handle Accessory Selection Guide

Part Number	Price	Description
F0S03C		NEMA 1/12 flex shaft cable operator for G-Frame MCCB. Cable length: 3ft [0.91 m]
F0S06C		NEMA 1/12 flex shaft cable operator for G-Frame MCCB. Cable length: 6ft [1.83 m]
F1S03C		NEMA 1/12 flex shaft cable operator for F-Frame MCCB. Cable length: 3ft [0.91 m]
F1S06C		NEMA 1/12 flex shaft cable operator for F-Frame MCCB. Cable length: 6ft [1.83 m]
F3S03C		NEMA 1/12 flex shaft cable operator for K-Frame MCCB. Cable length: 3ft [0.91 m]
F3S06C		NEMA 1/12 flex shaft cable operator for K-Frame MCCB. Cable length: 6ft [1.83 m]
F4S04C		NEMA 1/12 flex shaft cable operator for L-Frame MCCB. Cable length: 4ft [1.22 m]
F4S06C		NEMA 1/12 flex shaft cable operator for L-Frame MCCB. Cable length: 6ft [1.83 m]

3P Series Molded Case Circuit Breakers Accessories



High Performance Flex Shaft™ Flange Handles

These two-position flange handles feature external front mounting. Models are available for NEMA 1/3R/12 and 4/4X enclosures and for G-frame, F-frame, K-frame or L-frame model MCCBs. All models are lockable in the OFF position and are defeatable. The Flex Shaft handle will accept up to three padlock shackles, each with a maximum diameter of 0.375 in [9.5 mm]. Each item includes a high-strength nylon handle, breaker operating mechanism, and cable.

Flange Handle Accessory Selection Guide

Part Number	Price	Description
F0S03HP		3ft [0.91 m] cable length, NEMA 1/3R/12. For use with G-frame model MCCBs.
F0S06HP		6ft [1.83 m] cable length, NEMA 1/3R/12. For use with G-frame model MCCBs.
F1S03HP		3ft [0.91 m] cable length, NEMA 1/3R/12. For use with F-frame model MCCBs.
F1S06HP		6ft [1.83 m] cable length, NEMA 1/3R/12. For use with F-frame model MCCBs.
F3S03HP		3ft [0.91 m] cable length, NEMA 1/3R/12. For use with K-frame model MCCBs.
F3S06HP		6ft [1.83 m] cable length, NEMA 1/3R/12. For use with K-frame model MCCBs.
F4S04HP		4ft [1.22 m] cable length, NEMA 1/3R/12. For use with L-frame model MCCBs.
F4S06HP		6ft [1.83 m] cable length, NEMA 1/3R/12. For use with L-frame model MCCBs.
F0S03HPX		3ft [0.91 m] cable length, NEMA 4/4X. For use with G-frame model MCCBs.
F0S06HPX		6ft [1.83 m] cable length, NEMA 4/4X. For use with G-frame model MCCBs.
F1S03HPX		3ft [0.91 m] cable length, NEMA 4/4X. For use with F-frame model MCCBs.
F1S06HPX		6ft [1.83 m] cable length, NEMA 4/4X. For use with F-frame model MCCBs.
F3S03HPX		3ft [0.91 m] cable length, NEMA 4/4X. For use with K-frame model MCCBs.
F3S06HPX		6ft [1.83 m] cable length, NEMA 4/4X. For use with K-frame model MCCBs.
F4S04HPX		4ft [1.22 m] cable length, NEMA 4/4X. For use with L-frame model MCCBs.
F4S06HPX		6ft [1.83 m] cable length, NEMA 4/4X. For use with L-frame model MCCBs.

Note: A minimum bending radius of four inches is necessary for proper operation.

3P Series Molded Case Circuit Breakers Accessories

Field Mountable Accessories

Auxiliary Contact

The auxiliary contact provides circuit breaker contact status information by monitoring the position of the molded cross bar which contains the moving contact arms. The auxiliary switch is used for remote indication and interlock system verification, and consists of one SPDT switch housed in a plug-in module. Each SPDT switch has one 'a' and one 'b' contact. When the circuit breaker contacts are open, the 'a' contact is open and the 'b' contact is closed.

Note: Field installable auxiliary contacts are not available for the G and F frame breakers.

For G and F frame auxiliary contacts, order breakers with -AUX as part of the part number. Please see G and F-frame sections for available selections.

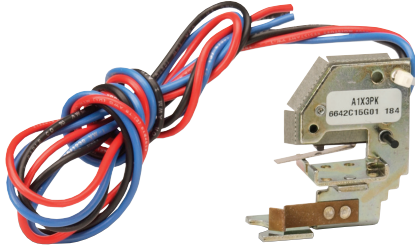

A1X3PK

Auxiliary Contact Accessory Selection Guide		
Part Number	Price	Description
A1X3PK		Field installable auxiliary contact for K-Frame MCCB, SPDT, 18" pigtail leads
A1X4PK		Field installable auxiliary contact for L-Frame MCCB, SPDT, 18" pigtail leads

K-Frame Electrical Ratings ^{1,2}					
	Max Volts	Frequency	Max Amperes	Dielectric Withstand Voltage	Notes
K-Frame Auxiliary Switch	600	50/60 Hz	6	2500	1. Endurance: 5000 electrical operations plus 1000 mechanical operations. 2. Pigtail wire size: 18 AWG (0.82 mm ²) 3. Non-inductive load
	125	DC	0.50 ³		
	250	DC	0.25 ³		

L-Frame Electrical Ratings ^{1,2}					
	Max Volts	Frequency	Max Amperes	Dielectric Withstand Voltage	Notes
L-Frame Auxiliary Switch	600	50/60 Hz	6	2500	1. Endurance: 5000 electrical operations plus 1000 mechanical operations. 2. Pigtail wire size: 18 AWG (0.82 mm ²) 3. Non-inductive load
	125	DC	0.50 ³		
	250	DC	0.25 ³		

Undervoltage Release

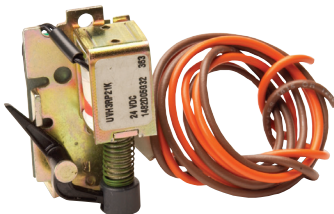

UVH3LP21K

This product monitors a voltage (typically a line voltage) and trips the circuit breaker when the voltage falls to between 70% and 35% of the solenoid coil rating. It consists of a continuous rated solenoid, with a plunger and tripping lever mounted in a plug-in module.

Note: The undervoltage release is a pre-installed accessory on G-Frame and F-Frame breakers.

Undervoltage Release Accessory Selection Guide		
Part Number	Price	Description
UVH3LP08K		Field installable 110 - 127 VAC undervoltage release for K-Frame MCCB
UVH4LP08K		Field installable 110 - 127 VAC undervoltage release for L-Frame MCCB
UVH3LP21K		Field installable 24 VDC undervoltage release for K-Frame MCCB
UVH4LP21K		Field installable 24 VDC undervoltage release for L-Frame MCCB

K-Frame Undervoltage Release Mechanism	Supply Voltage	Dropout Voltage		Pickup Voltage	VA	Notes	
		Min	Max	Max			
	24 VDC	8.4	16.8	20.4	3.1		1. Endurance: 5000 electrical operations plus 1000 mechanical operations. 2. 50/60 Hz
	110 VAC ²				1.8		
	120 VAC ²	44.5	77.0	93.5	2.1		
127 VAC ²				2.4			

L-Frame Undervoltage Release Mechanism	Supply Voltage	Dropout Voltage		Pickup Voltage	VA	Notes	
		Min	Max	Max			
	24 VDC	8.4	16.8	20.4	3.1		1. Endurance: 5000 electrical operations plus 1000 mechanical operations. 2. 50/60 Hz
	110 VAC ²				1.8		
	120 VAC ²	44.5	77.0	93.5	2.1		
127 VAC ²				2.4			

3P Series Molded Case Circuit Breakers Accessories

Field Mountable Accessories

Shunt Trip

The Shunt Trip provides remote controlled tripping of the circuit breaker. Consisting of an intermittent rated solenoid with a tripping plunger and a cutoff switch assembled to a plug-in module, shunt trip coils are designed to be applied at specific AC or DC voltages.

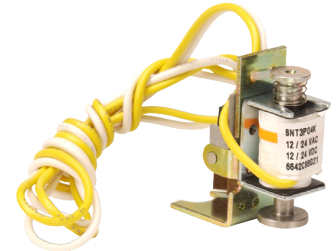

SNT3P04K

Shunt Trip Accessory Selection Guide		
Part Number	Price	Description
SNT3P11K		Field installable 110/240 VAC / 110/125 VDC shunt trip for K-Frame MCCB.
SNT4RP11K		Field installable 110/240 VAC shunt trip for L-Frame MCCB
SNT3P04K		Field installable 12/24 VAC/DC shunt trip for K-Frame MCCB
SNT4RP03K		Field installable 12/24 VAC/DC shunt trip for L-Frame MCCB

K-Frame Shunt Trip	Supply Voltage	Min Operating Voltage	VA	Supply Voltage	Min Operating Voltage	VA	Notes
	VAC 50/60 Hz			VDC			
	12	9	45	12	8.4	35	
24	200		24	170			
110	60	100	110	77	110		
120		120	120	77	130		
127		140	125	77	140		
208		420	-	-	-		
220		470	-	-	-		
240		550	-	-	-		

1. Endurance: 5000 electrical operations plus 1000 mechanical operations.
2. Approx. unlatching time: 6 ms
Approx. total circuit breaker contact opening time: 8 ms

L-Frame Shunt Trip	Supply Voltage	Min Operating Voltage	VA	Supply Voltage	Min Operating Voltage	VA	Notes
	VAC 50/60 Hz			VDC			
	12	9	45	12	9	35	
24	200		24	170			
110	60	100	-	-	-		
120		120	-	-	-		
127		140	-	-	-		
208		420	-	-	-		
220		470	-	-	-		
240		550	-	-	-		

1. Endurance: 5000 electrical operations plus 1000 mechanical operations.
2. Approx. unlatching time: 6 ms
Approx. total circuit breaker contact opening time: 18 ms

3P Series Molded Case Circuit Breakers

Accessories

Field Mountable Accessories

Six-wire Connector

This is a field installable multi-wire connector which allows six wires to be connected to the load side (OFF) end terminals. It is used to distribute the load from the circuit breaker to multiple devices without the use of separate distribution terminal blocks. UL listed for copper only as used on the load side (OFF) end. Includes mounting hardware, insulators and tin-plated aluminum connectors.

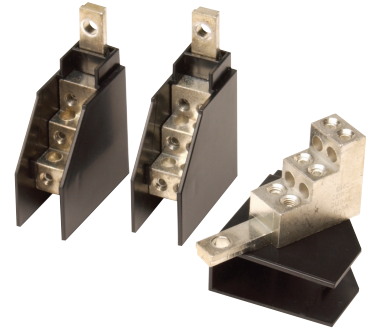

3TA100G6K

Six-wire Connector Accessory Selection Guide		
Part Number	Price	Description
3TA100G6K		For G-Frame MCCBs. Pkg. of 3. Wire size: 14 - 6 AWG, copper
3TA150F6K		For F-Frame MCCBs. Pkg. of 3. Wire size: 14 - 6 AWG, copper

Multi-Wire Box Type Wiring Lug

These multi-wire lugs allow for cost and space savings within a panel and allow for improved short-circuit ratings by eliminating the need for power distribution blocks. Designed for load-side mounting. Choose for G-frame, F-frame, or K-frame model MCCBs. Mounting hardware and insulators included. Package of 3.



3TA100G3K

Multi-Wire Box Type Wiring Lug Selection Guide		
Part Number	Price	Description
3TA100G3K		100A, 3 openings, #14-2 AWG copper only. For use with G-frame model MCCBs.
3TA150F3K		225A, 3 openings, #14-2 AWG copper only. For use with F-frame model MCCBs.
3TA400K3K		400A, 3 openings, #14-2/0 AWG copper only. For use with K-frame model MCCBs.
3TA400K6K		400A, 6 openings, #14-3 AWG copper only. For use with K-frame model MCCBs.

Replacement Lug Kit

Line and load terminals provide wire connecting capabilities for specific ranges of continuous current ratings and wire types. Replacement lugs will accept wire types Cu/Al as standard.

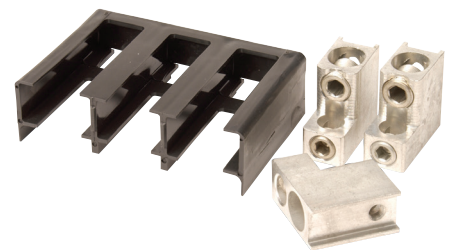

3TA401K

Replacement Lug Kit Accessory Selection Guide		
Part Number	Price	Description
3TA225FD		Replacement lug kit for F-Frame MCCB. Wire range (1) #4-4/0 (25-95 mm ²). Package of (3) terminals.
3TA401K		Replacement lug kit for K-Frame MCCB. Wire range (2) 2/0-250 kcmil or (1) 2/0-500 kcmil (70-240 mm ²). 3-pole kit (one terminal per pole and one terminal cover).
3TA603LDK		Replacement lug kit for L-Frame MCCB. 3-pole kit (one terminal per pole and one terminal cover). Wire range 400-500 AWG (185-240 mm ²), 2 conductors.

Note: G-frame terminals are factory-installed only. No replacement terminals available.

Din Rail Mounting Clip



GDIN

Din Rail Mount Clip Accessory Selection Guide		
Part Number	Price	Description
GDIN		Clip for mounting G-Frame to 35 mm Din rail. Mounting hardware included. Pkg of 1

3P Series Molded Case Circuit Breakers Accessories

Field Mountable Accessories

NEMA 12 Safety Door Hardware

Type C361 door interlocking safety handle kits are designed for use with AutomationDirect 3P series MCCBs and flexible handle when mounted in an SDN12, or equivalent, enclosure. These handles secure the SDN12 enclosure, protecting against unauthorized entry while the MCCB is in the ON position. Use them on enclosures with right-side flanges only and material thickness from 16 gauge through 3/16 in. All mounting hardware is included for enclosures up to 40in [101.6 cm] tall. The addition of the C361KR roller kit is necessary for enclosures taller than 40in [101.6 cm] that require a 3-point latch. See SDN12 Enclosures section for enclosure specifications.

Safety Door Hardware Selection Guide		
Part Number	Price	Description
<u>C361KJ4</u>		Handle length: 4in [10.16 cm]. Mounting hardware included for enclosures up to 40in [101.6 cm] tall. For taller enclosures that require a 3-point latch, the C361KR (purchase separately) will also be needed.
<u>C361KJ6</u>		Handle length: 6in [15.24 cm]. Mounting hardware included for enclosures up to 40in [101.6 cm] tall. For taller enclosures that require a 3-point latch, the C361KR (purchase separately) will also be needed.
<u>C361KR</u>		Door interlocking safety roller kit for use with the C361KJ4 and C361KJ6 safety handle kits when the SDN12 series enclosure is taller than 40in [101.6 cm] and 3-point latching is required. Kit includes roller and all hardware.

Note: The 1/4" x 1/2" standard mill rectangular locking bar is not supplied with these kits. The bar is supplied with the enclosures.

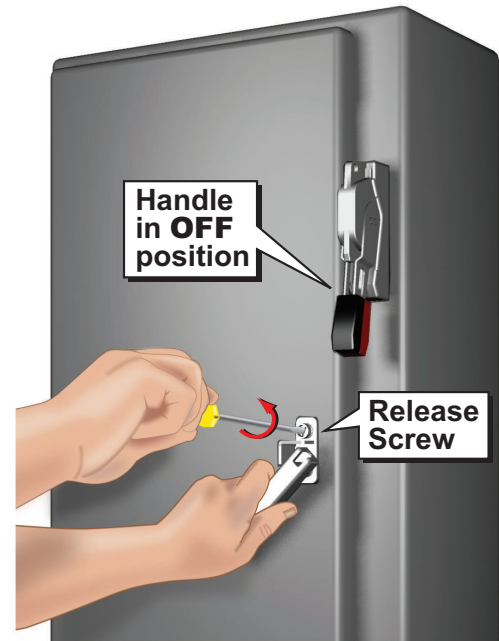

Safety Handle shown on enclosure