

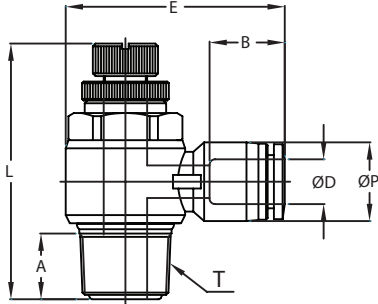

# Pneumatic Push-to-Connect Flow Control (Speed Controller) Valves

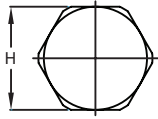

NITRA pneumatic push-to-connect **meter-in** flow control valve (speed controller) elbow with rotating thermoplastic (PBT) body, nickel-plated brass threads, stainless steel tube gripping claws, and pre-applied Teflon thread sealant (#10-32, M5 and G threads have O-ring instead of thread sealant). For use with polyurethane or nylon tubing. Two fittings per package.



*Inch/Metric Flow Control Valve*



*G-Thread (BSPP) Flow Control Valve*

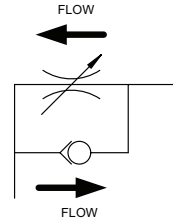

NITRA Elbow Flow Control Valve Meter-In													
Inch Sizes - dimensions in inches (in.)													
Part No.	Price	Size	øD	øP	T	L		E	A	B	H (Hex)	Package Weight (lbs)	Qty. per pack
						Min.	Max.						
<b>FVR18-10N</b>		1/8 in. x #10-32	1/8	0.30	UNF 10-32	1.06	1.15	0.85	0.14	0.44	5/16	0.1	2
<b>FVR532-10N</b>		5/32 in. (4 mm) x #10-32	5/32	0.41	UNF 10-32	1.06	1.15	1.04	0.14	0.59	5/16	0.1	2
<b>FVR532-18N</b>		5/32 in. (4 mm) x 1/8 NPT	5/32	0.41	NPT 1/8	1.37	1.57	1.21	0.32	0.59	7/16	0.1	2
<b>FVR14-10N</b>		1/4 in. x #10-32	1/4	0.51	UNF 10-32	1.06	1.15	1.13	0.14	0.66	5/16	0.1	2
<b>FVR14-18N</b>		1/4 in. x 1/8 NPT	1/4	0.51	NPT 1/8	1.37	1.57	1.26	0.32	0.66	7/16	0.1	2
<b>FVR14-14N</b>		1/4 in. x 1/4 NPT	1/4	0.51	NPT 1/4	1.60	1.85	1.41	0.43	0.66	19/32	0.2	2
<b>FVR516-18N</b>		5/16 in. (8 mm) x 1/8 NPT	5/16	0.57	NPT 1/8	1.37	1.56	1.31	0.32	0.72	7/16	0.1	2
<b>FVR516-14N</b>		5/16 in. (8 mm) x 1/4 NPT	5/16	0.57	NPT 1/4	1.59	1.85	1.47	0.43	0.72	19/32	0.2	2
<b>FVR516-38N</b>		5/16 in. (8 mm) x 3/8 NPT	5/16	0.57	NPT 3/8	1.88	2.16	1.59	0.52	0.72	3/4	0.3	2
<b>FVR38-14N</b>		3/8 in. x 1/4 NPT	3/8	0.69	NPT 1/4	1.60	1.85	1.57	0.43	0.79	19/32	0.2	2
<b>FVR38-38N</b>		3/8 in. x 3/8 NPT	3/8	0.69	NPT 3/8	1.89	2.16	1.65	0.52	0.79	3/4	0.4	2
<b>FVR38-12N</b>		3/8 in. x 1/2 NPT	3/8	0.69	NPT 1/2	2.12	2.41	1.86	0.65	0.79	15/16	0.4	2
<b>FVR12-38N</b>		1/2 in. x 3/8 NPT	1/2	0.82	NPT 3/8	1.89	2.16	1.78	0.52	0.90	3/4	0.4	2
<b>FVR12-12N</b>		1/2 in. x 1/2 NPT	1/2	0.82	NPT 1/2	2.12	2.41	1.99	0.65	0.90	15/16	0.4	2

BSPT = British Standard Pipe Taper  
 BSPP = British Standard Pipe Parallel



# Pneumatic Push-to-Connect Flow Control (Speed Controller) Valves

NITRA Elbow Flow Control Valve Meter-In													
R-Thread (BSPT) Metric Sizes - dimensions in millimeters (mm)													
Part No.	Price	Size	øD	øP	T	L		E	A	B	H (Hex)	Package Weight (lbs)	Qty. per pack
						Min.	Max.						
<b>FVR4M-M5</b>		4 mm (5/32 in.) x M5	4	10.5	M5*0.8p	27.1	29.1	25.4	3.6	14.9	8	0.1	2
<b>FVR4M-18R</b>		4 mm (5/32 in.) x R1/8	4	10.5	R 1/8	35.5	40.7	30.5	8.2	14.9	11	0.1	2
<b>FVR6M-M5</b>		6 mm x M5	6	12.5	M5*0.8p	27.1	29.1	27.8	3.6	16.4	8	0.1	2
<b>FVR6M-18R</b>		6 mm x R1/8	6	12.5	R 1/8	35.5	40.7	31.3	8.2	16.4	11	0.1	2
<b>FVR6M-14R</b>		6 mm x R1/4	6	12.5	R 1/4	40.3	46.6	35.3	11.0	16.4	15	0.2	2
<b>FVR8M-14R</b>		8 mm (5/16 in.) x R1/4	8	14.5	R 1/4	40.3	46.6	37.4	11.0	18.7	15	0.2	2
<b>FVR8M-38R</b>		8 mm (5/16 in.) x R3/8	8	14.5	R 3/8	46.9	54.9	40.4	12.2	18.7	19	0.1	2
<b>FVR10M-14R</b>		10 mm x R1/4	10	17.5	R 1/4	40.3	46.6	38.8	11.0	20.1	15	0.1	2
<b>FVR10M-38R</b>		10 mm x R3/8	10	17.5	R 3/8	46.9	54.9	42.1	12.2	20.1	19	0.2	2
<b>FVR10M-12R</b>		10 mm x R1/2	10	17.5	R 1/2	54.0	60.1	47.3	16.5	20.1	24	0.4	2
<b>FVR12M-38R</b>		12 mm x R3/8	12	20.5	R 3/8	46.9	54.9	45.2	12.2	22.8	19	0.4	2
<b>FVR12M-12R</b>		12 mm x R1/2	12	20.5	R 1/2	54.0	60.1	50.1	16.5	22.8	24	0.4	2
G-Thread (BSPP) Metric Sizes - dimensions in millimeters (mm)													
<b>FVR4M-18G</b>		4 mm (5/32 in.) x G1/8	4	10.5	G 1/8	34.6	39.8	30.3	6.0	15.3	8	0.2	2
<b>FVR6M-18G</b>		6 mm x G1/8	6	12.5	G 1/8	34.6	39.8	31.2	6.0	16.4	8	0.2	2
<b>FVR6M-14G</b>		6 mm x G1/4	6	12.5	G 1/4	39.8	46.1	35.2	8.0	16.4	12	0.3	2
<b>FVR6M-38G</b>		6 mm x G3/8	6	12.5	G 3/8	47.7	54.9	38.7	8.0	16.4	14	0.4	2
<b>FVR8M-14G</b>		8 mm (5/16 in.) x G1/4	8	14.5	G 1/4	39.8	46.1	36.9	8.0	18.3	12	0.2	2
<b>FVR8M-38G</b>		8 mm (5/16 in.) x G3/8	8	14.5	G 3/8	47.7	54.9	39.9	8.0	18.3	14	0.3	2
<b>FVR8M-12G</b>		8 mm (5/16 in.) x G1/2	8	14.5	G 1/2	54.5	61.7	45.8	9.0	18.3	17	0.4	2
<b>FVR10M-38G</b>		10 mm x G3/8	10	17.5	G 3/8	47.7	54.9	42.2	8.0	19.7	14	0.4	2
<b>FVR10M-12G</b>		10 mm x G1/2	10	17.5	G 1/2	54.5	61.7	48.4	9.0	19.7	17	0.5	2

BSPT = British Standard Pipe Taper  
 BSPP = British Standard Pipe Parallel



# Pneumatic Push-to-Connect Flow Control (Speed Controller) Valves

## Flowrate Charts

FVR18-10N  
FVR4M-M5  
FVR532-10N  
FVR6M-M5  
FVR14-10N  
FVS18-10N  
FVS4M-M5  
FVS6M-M5  
FVS14-10N  
FVS532-10N

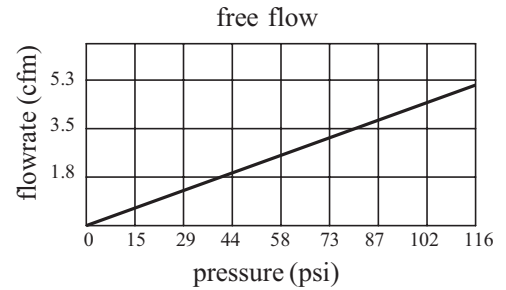
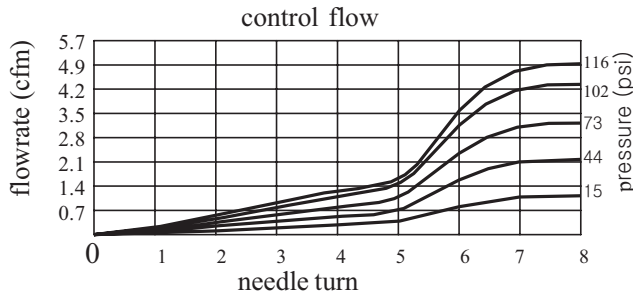

FVR4M-18R  
FVR532-18N  
FVR6M-18R  
FVR14-18N  
FVR516-18N  
FVS4M-18R  
FVS6M-18R  
FVS14-18N  
FVS516-18N

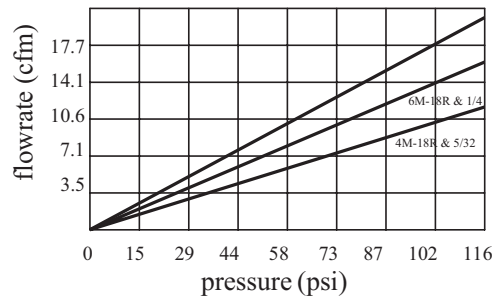
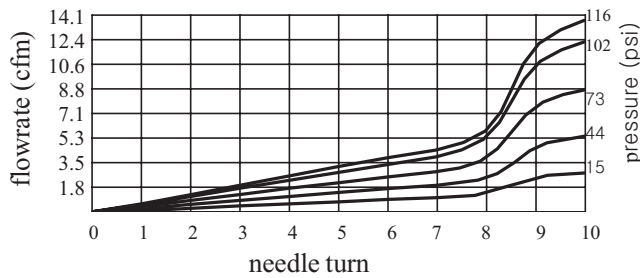

FVR6M-14R  
FVR14-14N  
FVR8M-14R  
FVR516-14N  
FVR10M-14R  
FVR38-14N  
FVS6M-14R  
FVS14-14N  
FVS8M-14R  
FVS516-14N  
FVS10M-14R  
FVS38-14N

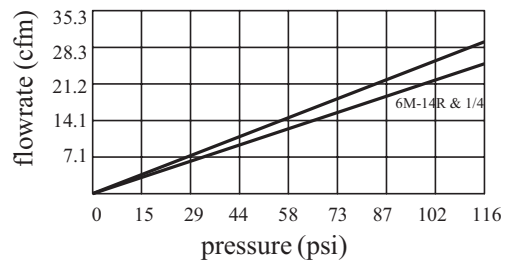
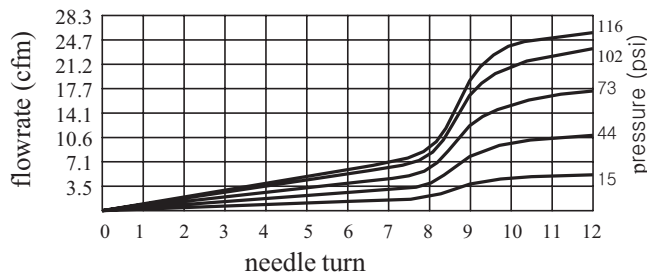

FVR8M-38R  
FVR516-38N  
FVR10M-38R  
FVR38-38N  
FVR12M-38R  
FVR12-38N  
FVS8M-38R  
FVS516-38N  
FVS10M-38R  
FVS38-38N  
FVS12M-38R  
FVS12-38N

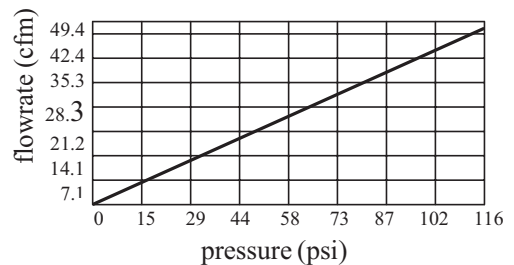
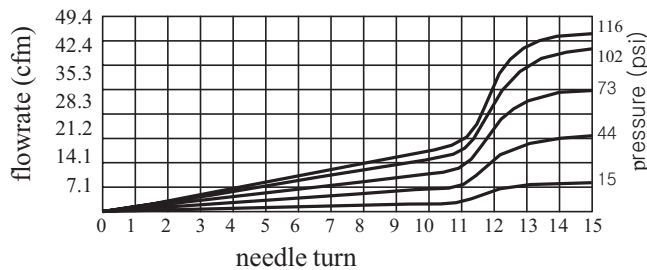

FVR10M-12R  
FVR38-12N  
FVR12M-12R  
FVR12-12N  
FVS10M-12R  
FVS38-12N  
FVS12-12N  
FVS12M-12R

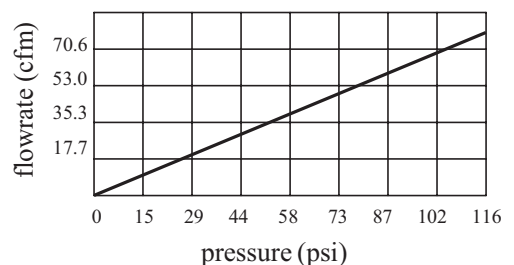
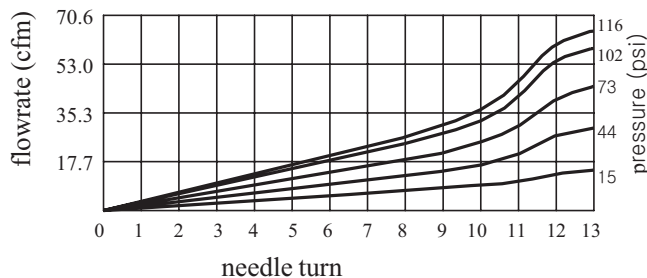



# Pneumatic Push-to-Connect Flow Control (Speed Controller) Valves

**NITRA** Pneumatic Push-to-Connect Flow Control (Speed Controller) Valves provide accurate airflow regulation for precise speed control of pneumatic cylinders. **NITRA** flow control valve bodies are made of a strong thermoplastic (PBT) and have stainless steel tube gripping claws. Threaded components are made of nickel-plated brass and have pre-applied Teflon thread sealant (O-ring on #10-32, M5 and G threads). Flow control valve bodies can be rotated after installation to allow for variations in piping direction. **NITRA** Polyurethane and Nylon 12 tubing is easily connected by simply inserting the tubing end into the fitting. To release the tubing, press the circular release ring and the tubing can be easily pulled out.

## Features

- Meter-in , meter-out and in-line configurations
- Inch and metric sizes available
- NPT, BSPT (R) and BSPP (G) threads available
- Tough thermoplastic bodies, stainless steel tube gripping claws, nickel-plated threads with pre-applied Teflon sealant (O-ring on #10-32, M5 and G threads)
- Bodies can be rotated after installation
- Release rings are color coded to differentiate between meter-in and meter-out
- For use with air only.
- Working pressure: -29.5" Hg to 150 psi.
- Working Temperature 32 to 140°F (0 to 60°C)

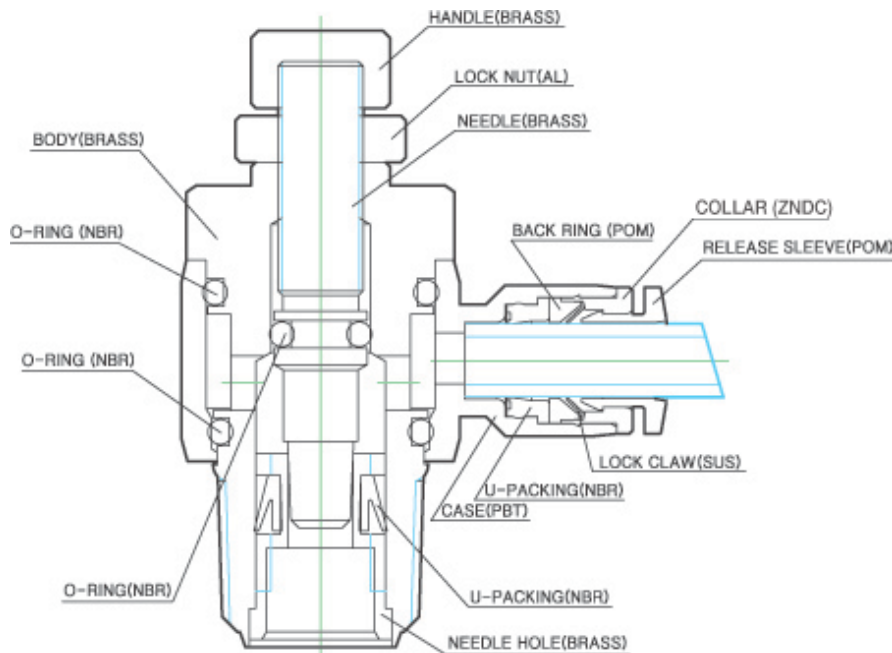

*Flow Control Valve Cut-away Diagram*