



D-Series Heavy Duty Pneumatic Cylinders – 3-1/4 inch Bore

3-1/4 in. Bore, Double-acting, Tapped End Caps, Magnetic Piston



NITRA heavy duty pneumatic, NFPA interchangeable cylinder, 3-1/4 inch bore, 1 inch diameter piston rod, 1/2" female NPT ports, double acting, tapped end caps and one side for mount, flange, pivot and clevis mount options available. Some models available with cushions on both ends.

3-1/4 in bore, double acting, tapped end caps						
Part Number no Cushions	Price	Part Number w/ Cushions*	Price	Stroke Length (in)	"A" (in [mm])	Weight (lbs)
D52010DT-M		D52010DT-MC		1	5.25 [133.3]	6.8
D52020DT-M		D52020DT-MC		2	6.25 [158.7]	7.3
D52030DT-M		-		3	7.25 [184.1]	7.7
-		D52040DT-MC		4	8.25 [209.5]	8.1
-		D52050DT-MC		5	9.25 [234.9]	8.6
D52070DT-M		-		7	11.25 [285.7]	9.4
-		D52080DT-MC		8	12.25 [311.1]	9.9
D52110DT-M		-		11	15.25 [387.3]	11.2
D52140DT-M		-		14	18.25 [463.5]	12.5
-		D52160DT-MC		16	20.25 [514.3]	13.4
D52180DT-M		-		18	22.25 [565.1]	14.2
D52200DT-M		D52200DT-MC		20	24.25 [615.9]	15.1
-		D52240DT-MC		24	28.25 [717.5]	16.8

Specifications	
Aluminum hard anodized to 60 Rc cylinder body	8.3 sq. in. piston area
Solid aluminum bar, black anodized end caps	Pressure rating 250 psi, AIR ONLY
High tensile ground and polished hard chrome plated steel piston rod	Non-detergent petroleum based oil is recommended
Low friction Buna-N seals	Temperature range -40°F to 250°F (-40 to 121°C)
Extend force at 100 psi = 830 lb.	Retract force at 100 psi = 751 lb.
Filtration: Not essential, however a standard 40 micron filter placed upstream will prolong seal life.	

Mounting Accessories		
Style	NFPA Designation	Part No.
Front Flange	MF1	DFM-4
Rear Flange	MF2	DFM-4
Rear Pivot	MP4	DPA-4

* The cushions decelerate the piston rod over the last 11/16 inch (approx.) of stroke and are adjustable. Cushioned cylinders have an adjustable orifice and pre-lubricated nitrile cushion seal.

Dimensions

inches [mm]

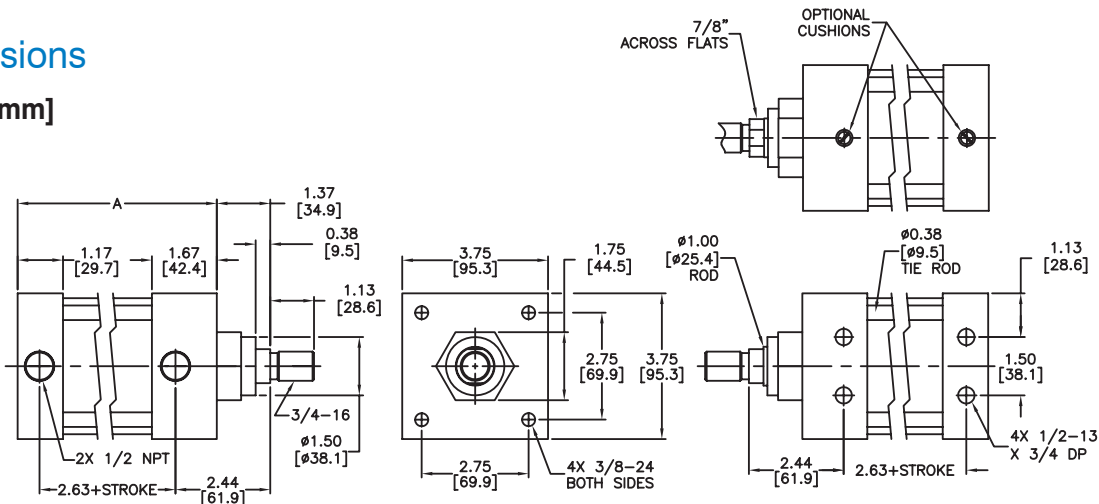



D-Series Heavy Duty Pneumatic Cylinders

Nitra Heavy Duty Pneumatic Air Cylinders

The NITRA Pneumatics D-Series heavy duty cylinders include bore sizes from 1-1/2" to 4" and stroke lengths from 1" to 24" to meet a broad range of applications where abusive conditions exist. These heavy duty cylinders are constructed with high quality aluminum components and a magnetic piston fitted with a PTFE wear band.

The cylinders are fitted with a Teflon® impregnated and hardcoat anodized heavy-duty external rod bearing. This bearing ensures smooth rod motion while maintaining rod rigidity and stability.

All D-Series cylinders have a magnetic piston that can be used along with solid state or reed switches for rod position sensing. The solid state and reed switches sense the rod position by emitting an electrical signal when the magnetized piston reaches a point adjacent to their location. Tie rod mounting allows fast and accurate positioning setup.

Cushioned cylinders are also available to provide end-of-stroke deceleration at both ends. The cushions decelerate the piston rod at the end-of-stroke and are adjustable with a flat head screwdriver.

Mounting Options

Flange Mounted:

The cylinder has holes on the ends of the end caps that allow easy mounting to a plate or other surfaces. See Flange Mount Kits in Accessories section.

Front Flange Mount (MF1)

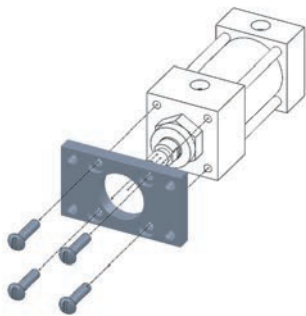

Rear Flange Mount (MF2)

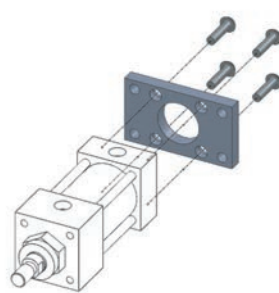

Side Mounted:

The cylinder has holes on the sides of the end caps that allow easy mounting to a surface. No mounting kit needed, only bolts.

Side Tap Mount (MS4)

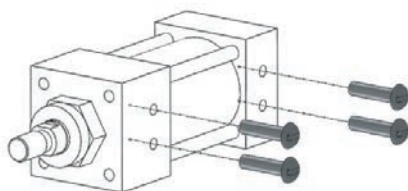

Features

- Interchangeable with other popular brands of NFPA cylinders
- Available bore sizes: 1-1/2", 2", 2-1/2", 3-1/4", 4"
- Wide selection of stroke lengths
- All models are double-acting
- Head and tail caps drilled for mounting
- All models have a magnetic piston
- Teflon® impregnated and hardcoat anodized heavy-duty external rod bearing
- 250 psi max operating pressure
- Some models available with adjustable cushions (both ends)
- Made in the USA
- All models are typically available for same-day shipment

Operation

Double-acting cylinders have two compressed air ports. One of the ports will extend the rod in the "push" direction and the other port will retract the rod in the "pull" direction.

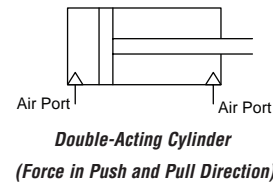

Rear Clevis and Rear Pivot Mount:

Clevis and Pivot mounts use a bracket that allows a pivoted mount. See Rear Clevis and Pivot Attachments in Accessories section.

Rear Clevis Mount (MP2)

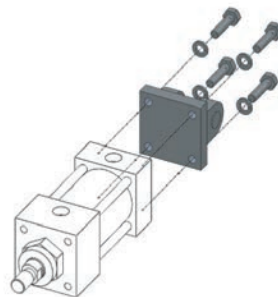

Rear Pivot Mount (MP4)

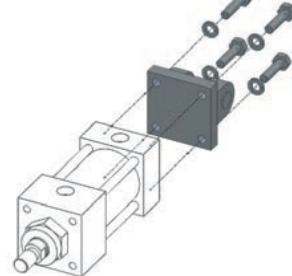

Rod Clevis:

The Rod Clevis uses a rod-mounted bracket and pin that allows a pivoted mount. Rod Eye uses a rod-mounted block with eye that allows a pivoted mount. See Accessories Section.

Rod Clevis

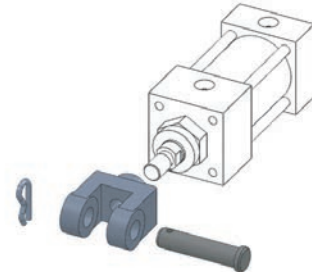

Rod Eye

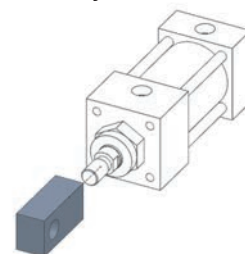

D-Series Heavy Duty Pneumatic Cylinders

Cylinder Features

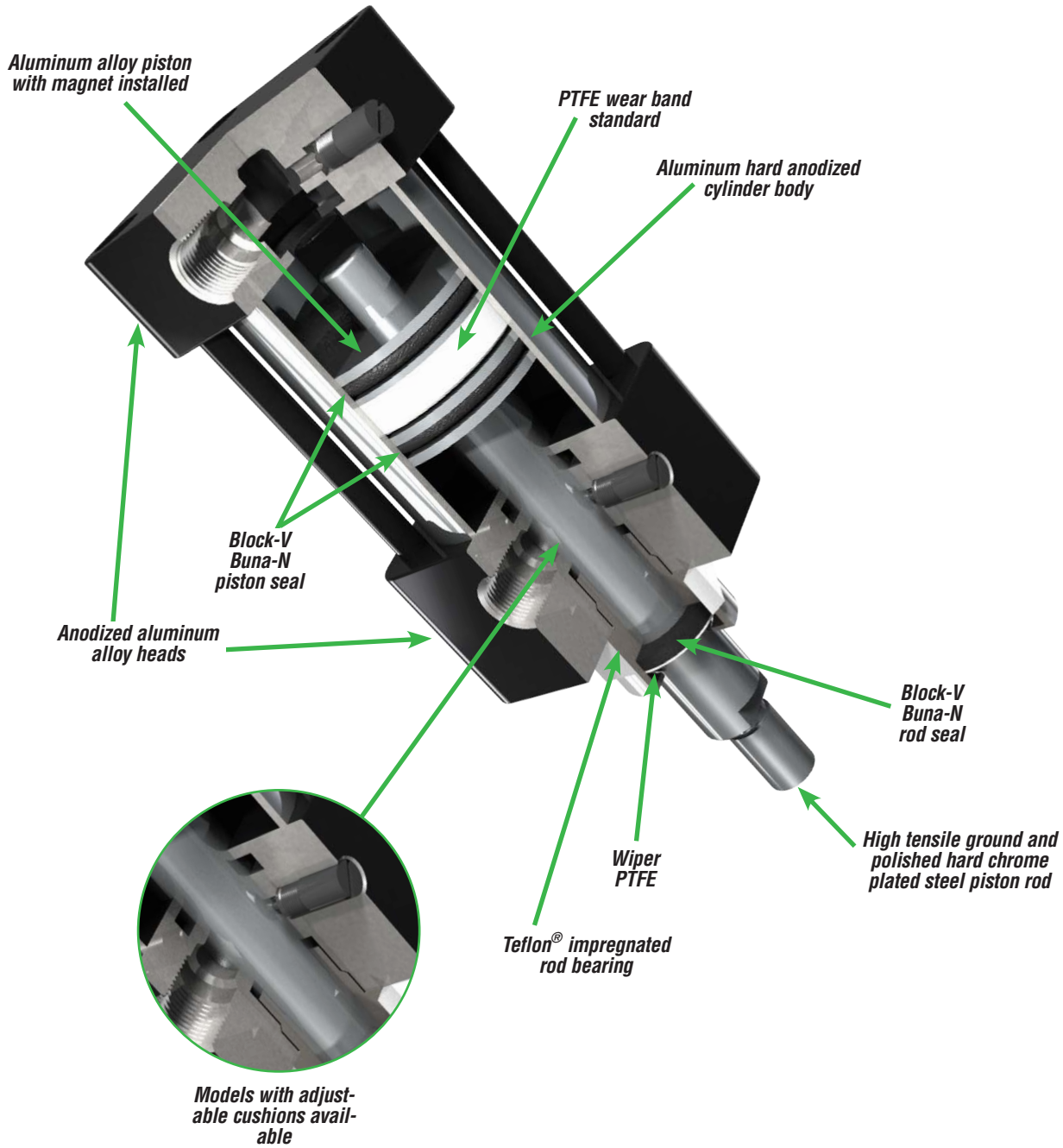

D-Series Heavy Duty Pneumatic Cylinders – Accessories

D-Series Heavy Duty Pneumatic Cylinder Accessories				
Part Number	Description	Pcs/Pkg	Wt (lb)	Price
DRE-1	Cylinder rod eye, 7/16-20 thread, for 1-1/2, 2 and 2-1/2 inch bore NITRA NFPA D-series pneumatic cylinders	1	0.4	
DPC-3	NFPA style MP2 cylinder rear clevis bracket and attaching hardware, for 2-1/2 inch bore NITRA NFPA D-series pneumatic cylinders	1	0.8	
DPA-2	NFPA style MP4 cylinder rear pivot eye and attaching hardware, for 2 inch bore NITRA NFPA D-series pneumatic cylinders	1	0.5	
DPA-4	NFPA style MP4 cylinder rear pivot eye and attaching hardware, for 3-1/4 inch bore NITRA NFPA D-series pneumatic cylinders	1	1.3	
DPA-5	NFPA style MP4 cylinder rear pivot eye and attaching hardware, for 4 inch bore NITRA NFPA D-series pneumatic cylinders	1	1.4	
DFM-1	NFPA style MF1 or MF2 cylinder flange mounting plate and attaching hardware, for 1-1/2 inch bore NITRA NFPA D-series pneumatic cylinders	1	0.3	
DFM-3	NFPA style MF1 or MF2 cylinder flange mounting plate and attaching hardware, for 2-1/2 inch bore NITRA NFPA D-series pneumatic cylinders	1	0.5	
DFM-4	NFPA style MF1 or MF2 cylinder flange mounting plate and attaching hardware, for 3-1/4 inch bore NITRA NFPA D-series pneumatic cylinders	1	3.0	

Rod Eye Dimensions

inches [mm]

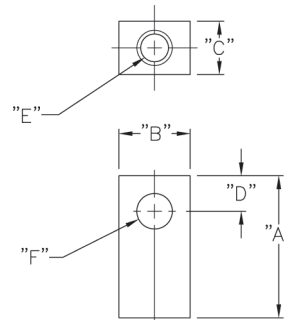

Rod Eye Dimension Table						
Part #	A	B	C	D	E	(Dia) F
DRE-1	2.00 [50.8]	1.00 [25.4]	0.75 [19.1]	0.50 [12.7]	7/16-20 x 3/4	ø0.50 [ø12.7]

D-Series Heavy Duty Pneumatic Cylinders – Accessories

Rear Clevis Dimensions

inches [mm]

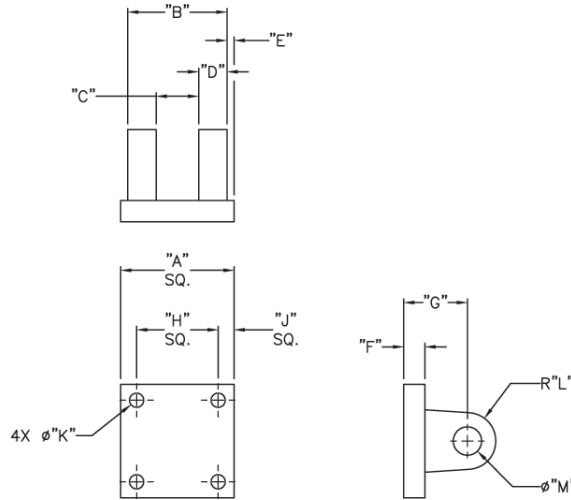

Note: Comes with pivot pin installed.

Rear Clevis Dimension Table												
Part #	A	B	C	D	E	F	G	H	J	(Dia) K	(R) L	(Dia) M
DPC-3	3.00 [76.2]	1.76 [44.7]	0.76 [19.3]	0.50 [12.7]	0.62 [15.7]	0.37 [9.5]	1.13 [28.6]	2.19 [55.6]	0.41 [10.3]	ø0.34 [ø8.6]	R 0.50 [R 12.7]	ø0.50 [ø12.8]

Rear Pivot Eye Dimensions

inches [mm]

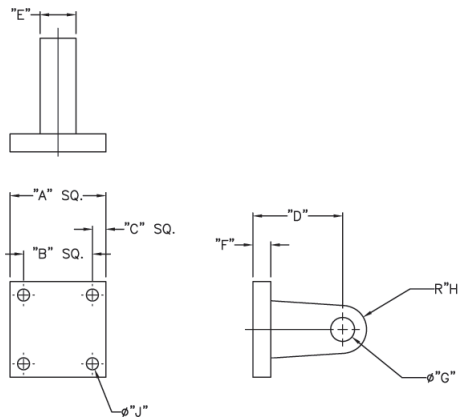

Rear Pivot Eye Dimension Table									
Part #	A	B	C	D	E	F	(Dia) G	(R) H	(Dia) J
DPA-2	2.50 [63.5]	1.84 [46.7]	0.33 [8.4]	1.13 [28.6]	0.75 [19.1]	0.37 [9.50]	ø0.5 [ø12.7]	R 0.50 [R 12.7]	ø0.34 [ø8.6]
DPA-4	3.80 [96.5]	2.77 [70.4]	0.52 [13.1]	1.87 [47.6]	1.25 [31.8]	0.63 [15.9]	ø0.75 [ø19.1]	R 0.75 [R 19.1]	ø0.41 [ø10.4]
DPA-5	4.50 [114.3]	3.32 [84.3]	0.59 [15.0]	1.87 [47.6]	1.25 [31.8]	0.63 [15.9]	ø0.75 [ø19.1]	R 0.75 [R 19.1]	ø0.41 [ø10.4]

D-Series Heavy Duty Pneumatic Cylinders – Accessories

Flange Attachment Dimensions

inches [mm]

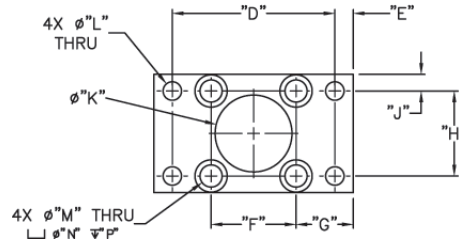
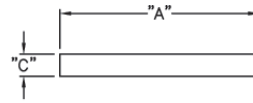

Flange Attachment Dimension Table

Part #	A	B	C	D	E	F	G	H	J	(Dia) K	(Dia) L	(Dia) M	(Dia) N	P
DFM-1	3.38 [85.9]	2.00 [50.8]	0.38 [9.7]	2.75 [69.9]	0.31 [7.9]	1.44 [36.6]	0.97 [24.6]	1.44 [36.6]	0.28 [7.1]	ϕ 1.30 [ϕ 33.0]	ϕ 0.31 [ϕ 7.9]	ϕ 0.38 [ϕ 9.7]	ϕ 0.66 [ϕ 16.8]	0.16 [4.1]
DFM-3	4.63 [117.6]	3.00 [76.2]	0.38 [9.7]	3.88 [98.6]	0.38 [9.7]	2.19 [55.6]	1.22 [31.0]	2.19 [55.6]	0.41 [10.4]	ϕ 1.74 [ϕ 44.2]	ϕ 0.38 [ϕ 9.7]	ϕ 0.38 [ϕ 9.7]	ϕ 0.66 [ϕ 16.8]	0.16 [4.1]
DFM-4	5.50 [139.7]	3.75 [95.3]	0.63 [16.0]	4.69 [119.1]	0.41 [10.4]	2.75 [69.9]	1.38 [35.1]	2.75 [69.9]	0.50 [12.7]	ϕ 2.06 [ϕ 52.3]	ϕ 0.44 [ϕ 11.2]	ϕ 0.42 [ϕ 10.7]	ϕ 0.82 [ϕ 20.8]	ϕ 0.36 [ϕ 9.1]



D-Series Heavy Duty Pneumatic Cylinder Replacement Seal Kit

Part Number	Description	Pcs/Pkg	Wt (lb)	Price
DSK-24	Seal kit, replacement, for NITRA D24 series pneumatic cylinders. Includes 4 Buna-N seals and PTFE rod wiper and wear strip.	1	0.1	
DSK-40	Seal kit, replacement, for NITRA D40 series pneumatic cylinders. Includes 4 Buna-N seals and PTFE rod wiper and wear strip.	1	0.1	

Position Switch Cross Reference Chart			
NITRA Switch Type	Cylinder Brand (may fit some of these cylinders)	Photo Example	Groove Illustration
CPS CPSF	NITRA A-Series, D-Series, F-Series		
CPS9C	DE-STA-CO Robohand SMC Compact Air		
CPS9D	Fabco Numatics Rotomation		
CPS9F	NITRA G-Series Fabco Festo Numatics Rotomation		
CPS9H	NITRA E-Series NITRA H-Series		
CPS9M	Norgren		
CPS9Q	NITRA G-Series Parker		
CPS9T	SMC		