



Pneumatic Manual Valves

Heavy Duty Toggle and Pushbutton Valves



Part No. GVS-520F-PB

NITRA GVS manual valves offer a simple, convenient method for directional control and other pneumatic valve applications. All valves can be thru-panel mounted for a very clean looking operator interface.

- Single stem design
- High flow
- Made in USA



Part No. GVS-520F-TD



Part No. GVS-521F-PB



Part No. GVS-521F-TD

Diagram "A"

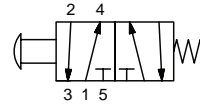

5-port, 2-position

Diagram "B"

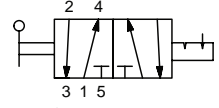

5-port, 2-position

Specifications				
Models	GVS-520F-PB	GVS-520F-TD	GVS-521F-PB	GVS-521F-TD
Price				
Weight (lbs)	0.1	0.1	0.1	0.15
Valve Type	5-port (4-way) 2-position			
Acting	Pushbutton, spring return, through panel mount	Toggle style actuator, detented, through panel mount	Pushbutton, spring return, through panel mount	Toggle style actuator, detented, through panel mount
Diagram	A	B	A	B
Port Size	#10-32 female threaded inlet(s), #10-32 female threaded outlet(s), #10-32 female threaded exhaust(s)	#10-32 female threaded inlet(s), #10-32 female threaded outlet(s), #10-32 female threaded exhaust(s)	1/8in FNPT inlet(s), 1/8in FNPT outlet(s), 1/8in FNPT exhaust(s)	1/8in FNPT inlet(s), 1/8in FNPT outlet(s), 1/8in FNPT exhaust(s)
Flow (Cv)	0.23	0.23	0.37	0.37
Fluid	Air (to be filtered by 40µ filter element)			
Min. / Max. Pressure	0 to 125 psi (0 to 8.62 bar)			
Temperature	-20°F to 160°F (-51°C to 71°C)			
Lubrication	Not Required			
Body	Aluminum/ Anodize, Brass/ Electroless Nickel, Acetal, Stainless Steel, Nylon, Brass, Buna-N			
Protection	IP65			

Dimensions mm [inches]

Note: For panel mounting
 • Maximum thickness 0.25"
 • Diameter Ø 0.484 thru

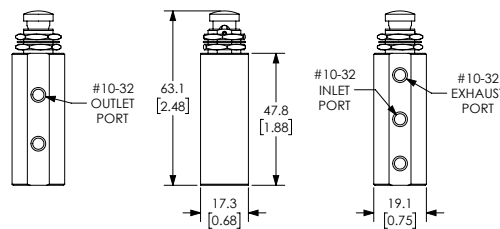

Part No. GVS-520F-PB

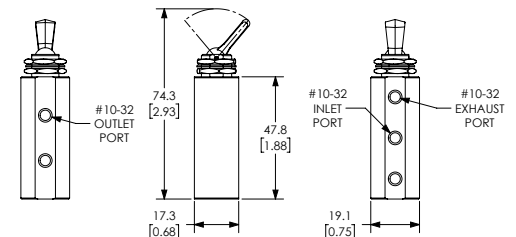

Part No. GVS-520F-TD

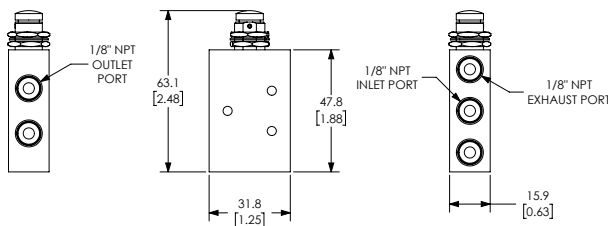

Part No. GVS-521F-PB

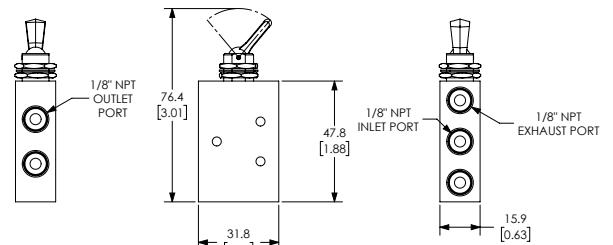



Part No. GVS-521F-TD

See our website for complete Engineering drawings.



GVP and GVS Series Pneumatic Valve Accessories



Nitra Pneumatic GVP and GVS Series Pneumatic Valve Accessories				
Item	Part No.	Description	Price	Weight (lbs)
	GV-BKT	NITRA 90 degree mounting bracket, plated steel. For use with all GVP and GVS valves.		0.5
	GV-CAM	NITRA roller cam actuator, plated steel, for use with all GVP and GVS valves. The roller is manufactured from durable acetal plastic. All cams feature a unique acetal pad which minimizes side load and virtually eliminates wear.		0.5
	GV-TMB	NITRA thumb actuator, plated steel, for use with all GVP and GVS valves.		0.5

Assembly Example

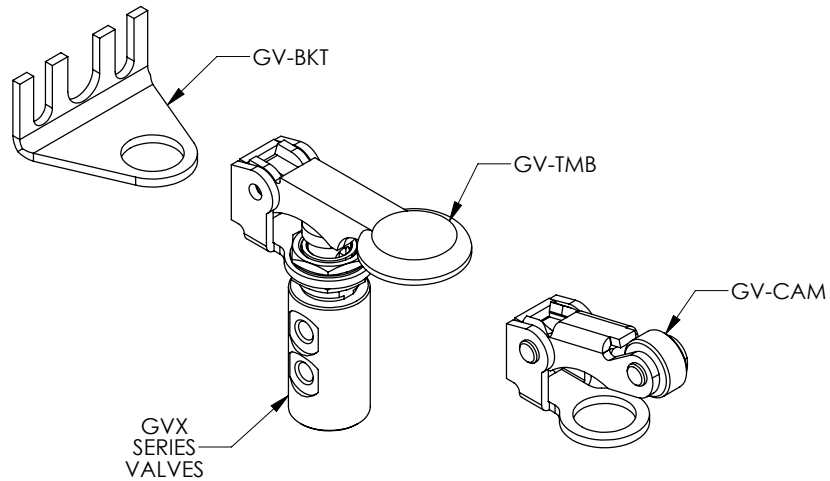

See our website for complete Engineering drawings.