



# F-Series All Stainless Steel Pneumatic Cylinders - 1-1/16 inch Bore

## 1-1/16 in. Bore, Double-acting, Front Nose Mount



Part no. F17030DN

NITRA pneumatic stainless steel round body, interchangeable, non-repairable cylinder, 1-1/16 inch bore, 1/8 inch female NPT ports, double acting, front nose mount.

All Stainless Steel Cylinder 1-1/16 in. bore, double acting, front nose mount				
Part Number	Stroke Length (in.)	"A" (in.)	Weight (lbs)	Price
F17005DN	0.5	3.75	0.6	
F17010DN	1.0	4.25	0.6	
F17020DN	2.0	5.25	0.6	
F17030DN	3.0	6.25	0.8	
F17040DN	4.0	7.25	0.8	
F17050DN	5.0	8.25	0.9	
F17060DN	6.0	9.25	0.9	
F17080DN	8.0	11.25	1.1	
F17100DN	10.0	13.25	1.2	
F17120DN	12.0	15.25	1.4	

Specifications	
300 series stainless steel cylinder body	0.90 sq. in. piston area
300 series stainless steel end caps	Pre-lubricated for maintenance-free life
300 series stainless steel piston rod	Pressure rating 250 psi
Low friction Buna-N seals	Temperature range -20°F to 200°F (-28 to 93°C)
Extend force at 100 psi = 90.0 lb.	Retract force at 100 psi = 82.3 lb.

Mount Style	Bracket	Nut
Front Nose Mount	FMB-6	FN-58-18
Rear Pivot Mount	-	-
Double End Mount	Front	-
	Rear	-

Cylinder rod clevis FRC-516-24

See end of F-series section for Accessories

## Dimensions

inches [mm]

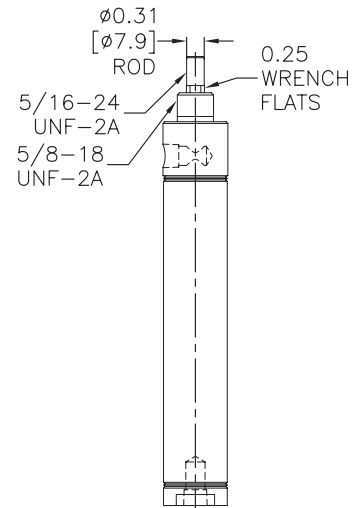
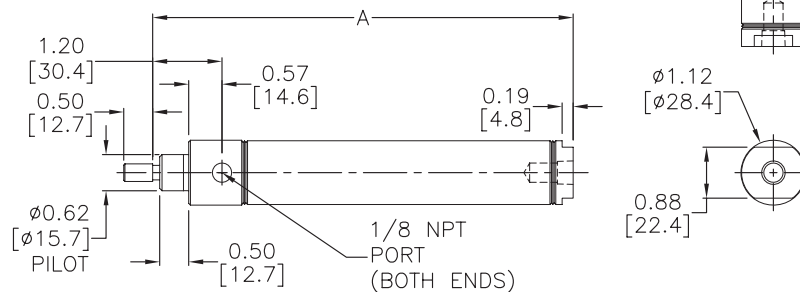



# F-Series All Stainless Steel Pneumatic Cylinders - 1-1/16 inch Bore

## 1-1/16 in. Bore, Double-acting, Double End Mount



Part no. F17030DD

NITRA pneumatic stainless steel round body, interchangeable, non-repairable cylinder, 1-1/16 inch bore, 1/8 inch female NPT ports, double acting, double end mount.

All Stainless Steel Cylinder 1-1/16 in. bore, double acting, double end mount				
Part Number	Stroke Length (in.)	"A" (in.)	Weight (lbs)	Price
F17010DD	1.0	4.84	0.6	
F17020DD	2.0	5.84	0.6	
F17030DD	3.0	6.84	0.8	
F17040DD	4.0	7.84	0.8	
F17050DD	5.0	8.84	0.9	
F17060DD	6.0	9.84	0.9	
F17080DD	8.0	11.84	1.1	
F17100DD	10.0	13.84	1.2	
F17120DD	12.0	15.84	1.4	

Specifications	
300 series stainless steel cylinder body	0.90 sq. in. piston area
300 series stainless steel end caps	Pre-lubricated for maintenance-free life
300 series stainless steel piston rod	Pressure rating 250 psi
Low friction Buna-N seals	Temperature range -20°F to 200°F (-28 to 93°C)
Extend force at 100 psi = 90.0 lb.	Retract force at 100 psi = 82.3 lb.

Mount Style	Bracket	Nut
Front Nose Mount	FMB-6	FN-58-18
Rear Pivot Mount	FPBP-2	-
Double End Mount	Front	FMB-6
	Rear	FMB-6

Cylinder rod clevis FRC-516-24

See end of F-series section for Accessories

## Dimensions

inches [mm]

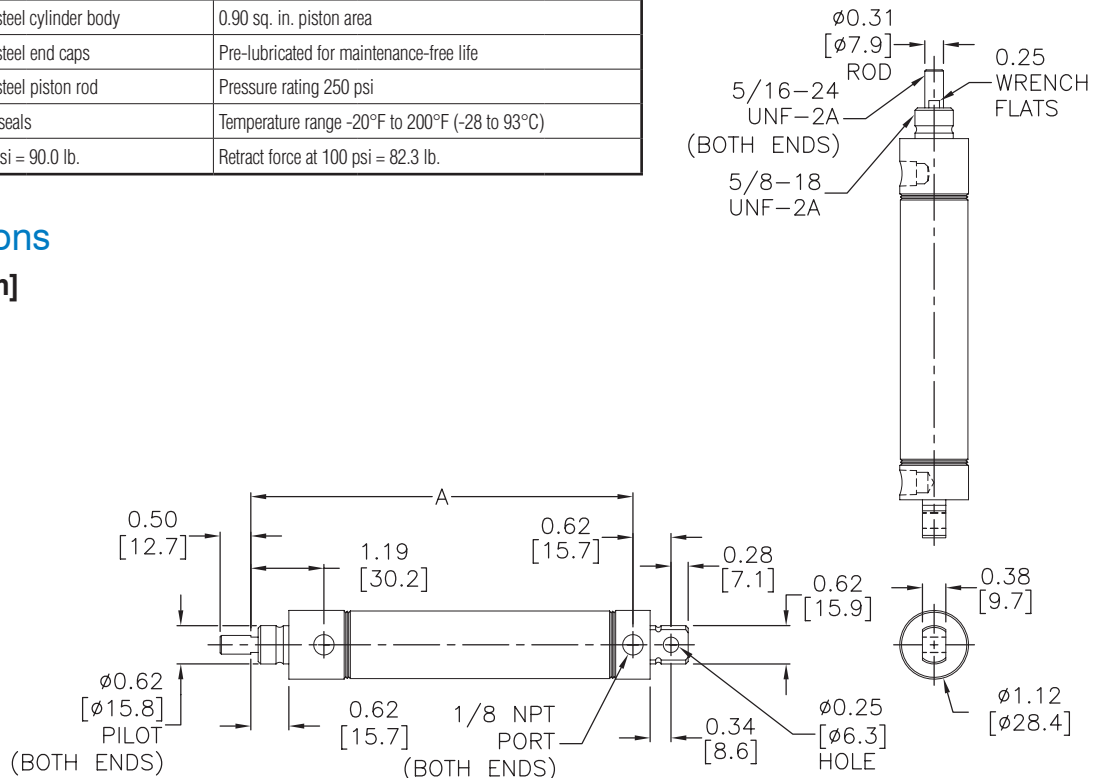



# F-Series All Stainless Steel Pneumatic Cylinder Accessories

F-Series All Stainless Steel Pneumatic Cylinder Accessories				
Part Number	Description	Pcs/Pkg	Wt (lb)	Price
<b>FN-58-18</b>	Cylinder mounting nut with 5/8-18 UNF-2B threads, stainless steel, used to mount 3/4 and 1-1/16 inch bore NITRA F-series round body air cylinders	1	0.1	
<b>FN-34-16</b>	Cylinder mounting nut with 3/4-16 UNF-2B threads, stainless steel, used to mount 1-1/2 inch bore NITRA F-series round body air cylinders	1	0.1	
<b>FN-114-12</b>	Cylinder mounting nut with 1-1/4-12 UNF-2B threads, stainless steel, used to mount 2 inch bore NITRA F-series round body air cylinders	1	0.3	
<b>FMB-6</b>	Cylinder mounting bracket, stainless steel, used to mount 3/4 and 1-1/16 inch bore NITRA F-series round body air cylinders	1	0.1	
<b>FMB-7</b>	Cylinder mounting bracket, stainless steel, used to mount 1-1/2 inch bore NITRA F-series round body air cylinders	1	0.2	
<b>FMB-11</b>	Cylinder mounting bracket, stainless steel, used to mount 2 inch bore NITRA F-series round body air cylinders	1	0.5	
<b>FPBP-2</b>	Cylinder pivot mounting bracket with pivot pin, stainless steel, used to mount 3/4 and 1-1/16 inch bore NITRA F-series round body air cylinders	1	0.1	
<b>FPBP-3</b>	Cylinder pivot mounting bracket with pivot pin, stainless steel, used to mount 1-1/2 inch bore NITRA F-series round body air cylinders	1	0.2	
<b>FPBP-4</b>	Cylinder pivot mounting bracket with pivot pin, stainless steel, used to mount 2 inch bore NITRA F-series round body air cylinders	1	0.3	
<b>FRC-14-28</b>	Cylinder rod clevis and hex nut, stainless steel, 1/4-28 thread, for use with 3/4 inch bore NITRA F-series round body air cylinders	1	0.1	
<b>FRC-516-24</b>	Cylinder rod clevis and hex nut, stainless steel, 5/16-24 thread, for use with 1-1/16 inch bore NITRA F-series round body air cylinders	1	0.1	
<b>FRC-716-20</b>	Cylinder rod clevis and hex nut, stainless steel, 7/16-20 thread, for use with 1-1/2 inch bore NITRA F-series round body air cylinders	1	0.2	
<b>FRC-12-20</b>	Cylinder rod clevis and hex nut, stainless steel, 1/2-20 thread, for use with 2 inch bore NITRA F-series round body air cylinders	1	0.2	

## Dimensions

inches [mm]

### FN-58-18

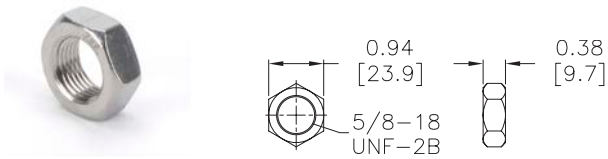

### FN-34-16

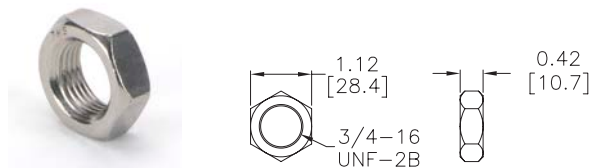

### FN-114-12

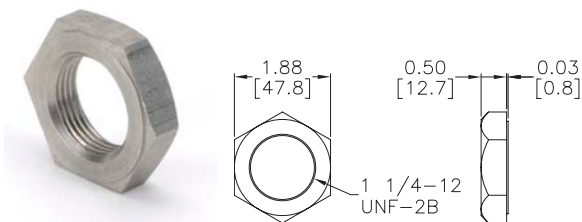

### FMB-6

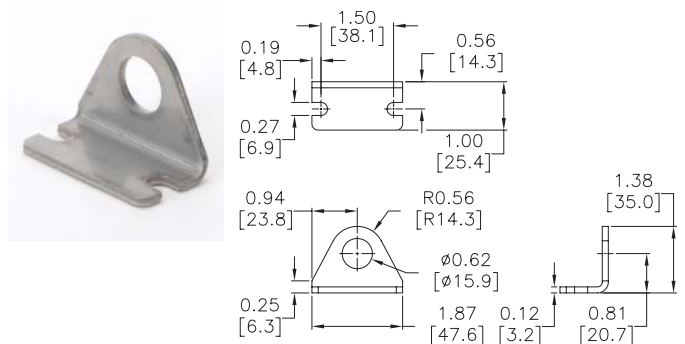

# F-Series All Stainless Steel Pneumatic Cylinder Accessories

## Dimensions

inches [mm]

### FMB-7

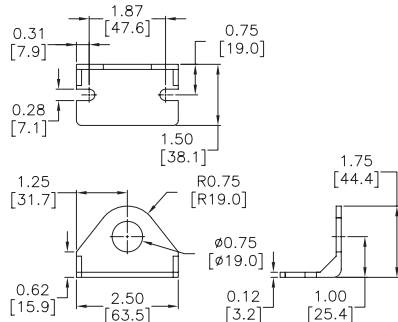

### FMB-11

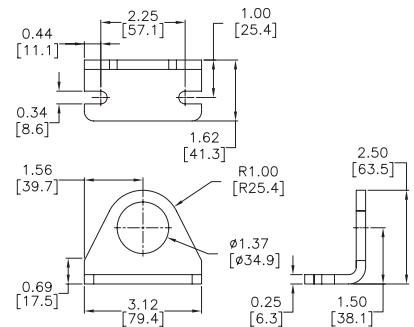

### FPBP-2

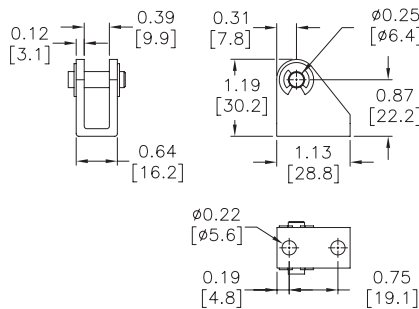

### FPBP-3

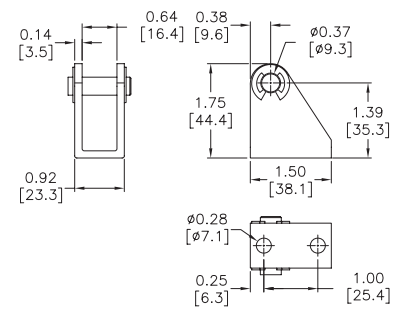

### FPBP-4

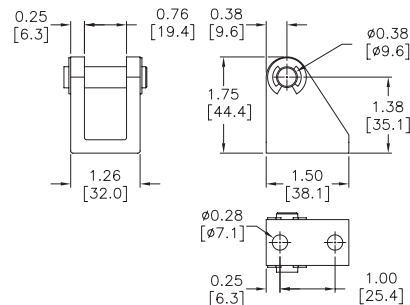

### FRC-14-28

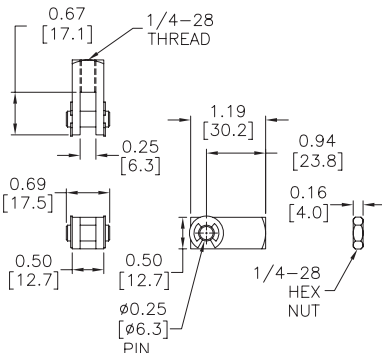

### FRC-516-24

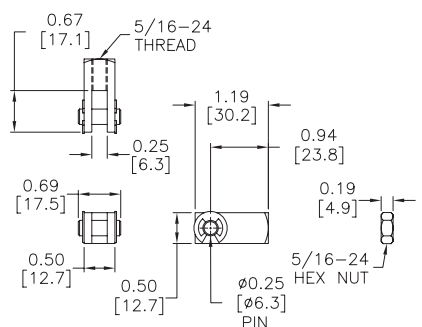



# F-Series All Stainless Steel Pneumatic Cylinder Accessories

## Dimensions

inches [mm]

### FRC-716-20

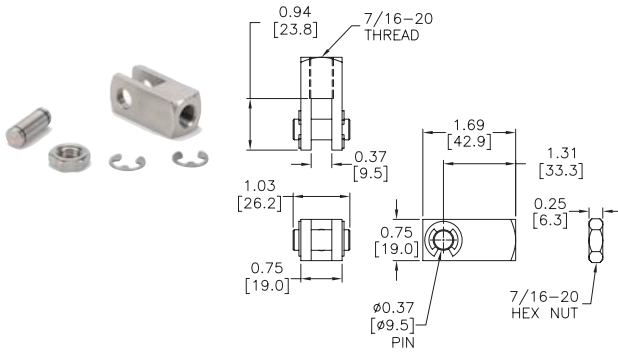

### FRC-12-20

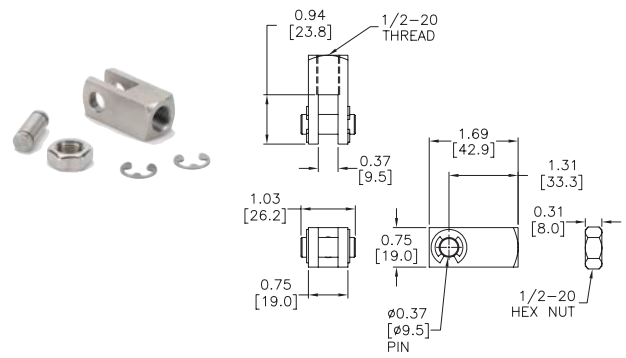

Position Switch Cross Reference Chart			
NITRA Switch Type	Cylinder Brand (may fit some of these cylinders)	Photo Example	Groove Illustration
CPS CPSF	NITRA A-Series, D-Series, F-Series		
CPS9C	DE-STA-CO Robohand SMC Compact Air		
CPS9D	Fabco Numatics Rotomation		
CPS9F	NITRA G-Series Fabco Festo Numatics Rotomation		
CPS9H	NITRA E-Series NITRA H-Series		
CPS9M	Norgren		
CPS9Q	NITRA G-Series Parker		
CPS9T	SMC		