

DC Output Modules

P3-64TD1

Sinking Output

The P3-64TD1 DC Output Module provides sixty-four 6–27 VDC sinking outputs with eight isolated commons.

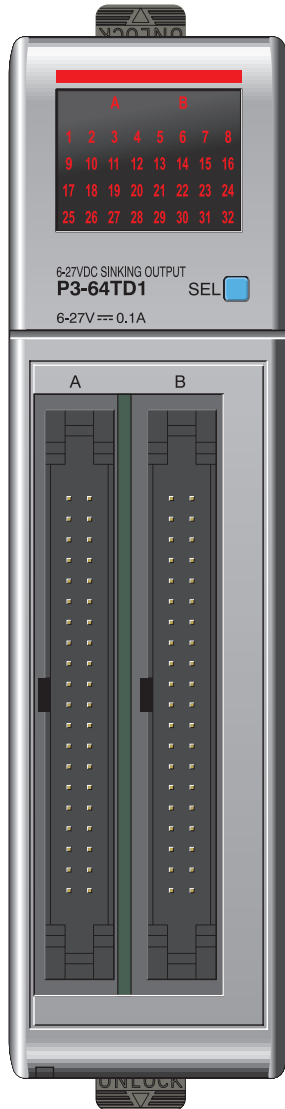

No terminal block sold for this module; ZIPLink required.

Output Specifications		
Outputs per Module	64 (sinking)	
Operating Voltage Range (Tolerance)	CE	6.25–24 VDC (-15% / + 20%)
	UL	6–27 VDC (-15% / +10%)
Maximum Output Current @ Temp	0.1 A / point, 0.8 A / common @ 60°C	
Minimum Output Current	0.4 mA	
Maximum Leakage Current	0.3 mA @ 30VDC	
On Voltage Drop	0.3 VDC @ 0.1 A	
Maximum Inrush Current	0.5 A for 10ms	
OFF to ON Response	≤ 0.2 ms	
ON to OFF Response	≤ 0.3 ms	
Connector Type	Two 40-pin IDC	
Status Indicators	Logic Side (32 points x 2)	
Commons	8 Isolated (8 points / common)	
External DC Power Required	24VDC ±10% @ 210mA	

General Specifications	
Operating Temperature	0°C– 60°C (32°F–140°F),
Storage Temperature	-20°C–70°C (-4°F–158°F)
Humidity	5 to 95% (non-condensing)
Environmental Air	No corrosive gases permitted
Vibration	IEC60068-2-6 (Test Fc)
Shock	IEC60068-2-27 (Test Ea)
Field to Logic Side Isolation	1500VAC applied for 1 minute
Insulation Resistance	>10MΩ @ 500VDC
Heat Dissipation	11.35 W
Enclosure Type	Open equipment
Module Keying to Backplane	Electronic
Module Location	Any I/O slot in any local, expansion, or remote base in a Productivity3000 system.
Field Wiring	Use ZIPLink wiring system. See Wiring Solutions.
Weight	160g (5.64 oz)
Agency Approvals	UL508 file E157382, Canada & USA UL1604 file E200031, Canada & USA CE (EN61131-2*) This equipment is suitable for use in Class 1, Division 2, Groups A, B, C and D or non-hazardous locations only.

*Meets EMC and Safety requirements. See the Declaration of Conformity for details.

Connector Specifications	
Connector Type	IDC style header with latch, Omron XG4A-4034
Number of Pins	40 point x 2
Pitch	0.1 in. (2.54 mm)

WARNING: Explosion hazard – Substitution of components may impair suitability for Class I, Division 2.

See Wiring Solutions for part numbers of ZIPLink cables and connection modules required with this I/O module.



Derating Chart

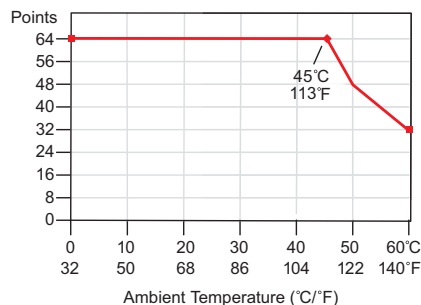

DC Output Modules

P3-64TD1 (cont'd)

Wiring Diagrams

Dual Power Source

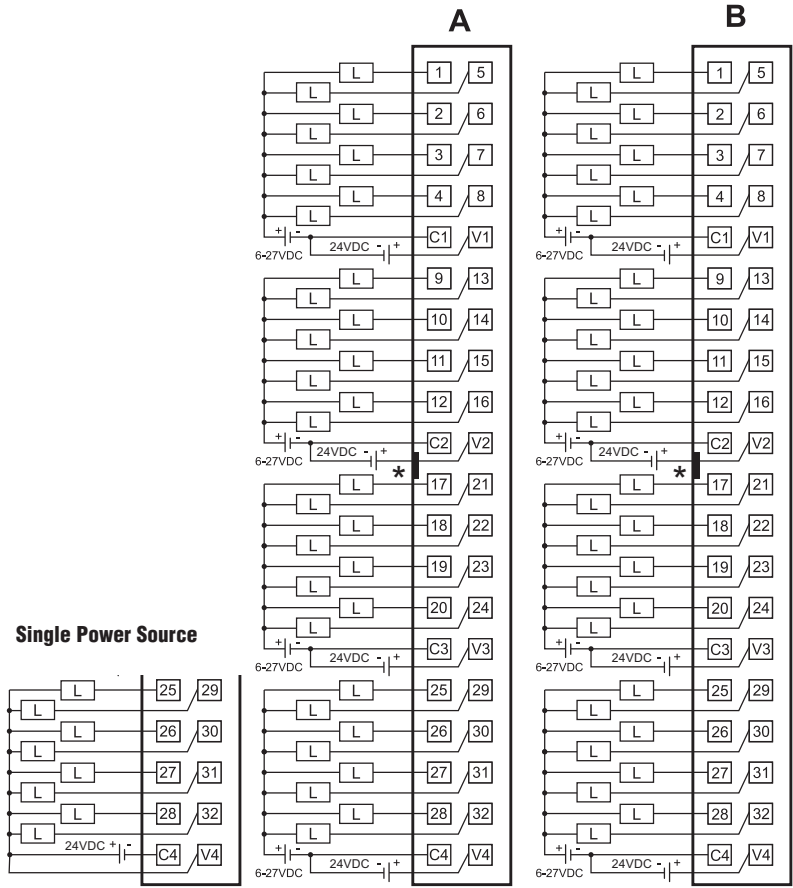

*Denotes key location of all associated ZIPLink cables

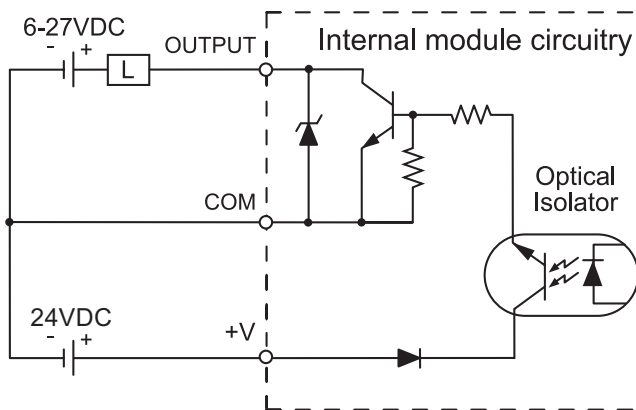

Wiring Solutions using the ZIPLink wiring system

ZIPLinks eliminate the normally tedious process of wiring between devices by utilizing prewired cables and DIN rail mount connector modules. It's as simple as plugging in a cable connector at either end or terminating wires at only one end. Prewired cables keep installation clean and efficient, using half the space at a fraction of the cost of standard terminal blocks. There are several wiring solutions available when using the ZIPLink System ranging from

PLC I/O-to-ZIPLink Connector Modules that are ready for field termination, options for connecting to third party devices, GS, DuraPulse and SureServo Drives, and specialty relay, transorb and communications modules. Pre-printed I/O-specific adhesive label strips for quick marking of ZIPLink modules are provided with ZIPLink cables. See the following solutions to help determine the best ZIPLink system for your application.

Solution 1: Productivity Series I/O Modules to ZIPLink Connector Modules

When looking for quick and easy I/O-to-field termination, a ZIPLink connector module used in conjunction with a prewired ZIPLink cable, consisting of an I/O terminal block at one end and a multi-pin connector at the other end, is the best solution.

Using the PLC I/O Modules to ZIPLink Connector Modules selector tables located in this section,

1. Locate your I/O module/PLC.
2. Select a ZIPLink Module.
3. Select a corresponding ZIPLink Cable.

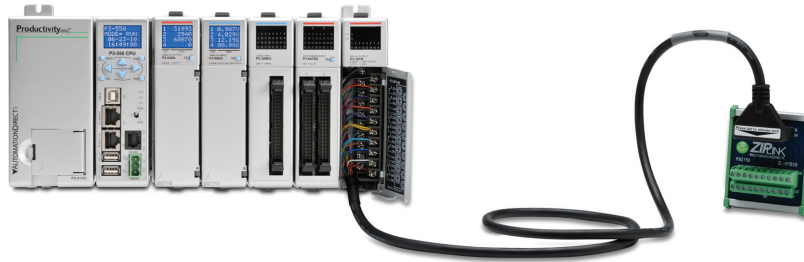

Solution 2: Productivity Series I/O Modules to ZIPLink Connector Modules

When wanting to connect I/O to another device within close proximity of the I/O modules, no extra terminal blocks are necessary when using the ZIPLink Pigtail Cables. ZIPLink Pigtail Cables are prewired to an I/O terminal block with color-coded pigtail with soldered-tip wires on the other end.

Using the I/O Modules to 3rd Party Devices selector tables located in this section,

1. Locate your PLC I/O module.
2. Select a ZIPLink Pigtail Cable that is compatible with your 3rd party device.

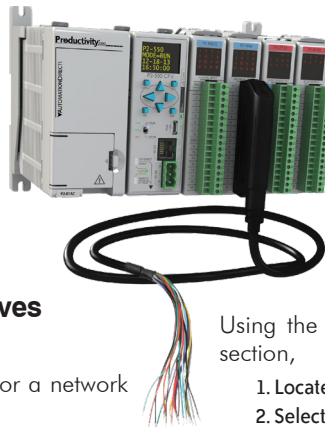

Solution 3: GS Series and DuraPulse Drives Communication Cables

Need to communicate via Modbus RTU to a drive or a network of drives?

ZIPLink cables are available in a wide range of configurations for connecting to PLCs and SureServo, SureStep, Stellar Soft Starter and AC drives. Add a ZIPLink communications module to quickly and easily set up a multi-device network.

Using the Drives Communication selector tables located in this section,

1. Locate your Drive and type of communications.
2. Select a ZIPLink cable and other associated hardware.



Solution 4: Serial Communications Cables

ZIPLink offers communications cables for use with *Direct*LOGIC, CLICK, and Productivity3000 CPUs, that can also be used with other communications devices. Connections include a 6-pin RJ12 or 9-pin, 15-pin and 25-pin D-sub connectors which can be used in conjunction with the RJ12 or D-Sub Feedthrough modules.

Using the **Serial Communications Cables** selector table located in this section,

1. Locate your connector type
2. Select a cable.



Solution 5: Specialty ZIPLink Modules

For additional application solutions, ZIPLink modules are available in a variety of configurations including stand-alone relays, 24VDC and 120VAC transorb modules, D-sub and RJ12 feedthrough modules, communication port adapter and distribution modules, and SureServo 50-pin I/O interface connection.

Using the **ZIPLink Specialty Modules** selector table located in this section,

1. Locate the type of application.
2. Select a ZIPLink module.



Solution 6: ZIPLink Connector Modules to 3rd Party Devices

If you need a way to connect your device to terminal blocks without all that wiring time, then our pigtail cables with color-coded soldered-tip wires are a good solution. Used in conjunction with any compatible ZIPLink Connector Modules, a pigtail cable keeps wiring clean and easy and reduces troubleshooting time.

Using the **Universal Connector Modules and Pigtail Cables** table located in this section,

1. Select module type.
2. Select the number of pins.
3. Select cable.



CPU I/O Modules to ZIPLink Connector Modules - Productivity3000®

Productivity3000 CPU Input Module ZIPLink Selector				
CPU		ZIPLink		
Input Module	# of Terms	Component	Module Part No.	Cable Part No.
P3-08NAS	20	Feedthrough	ZL-RTB20	ZL-P3-CBL20 *
P3-08ND3S	20	Feedthrough	ZL-RTB20	ZL-P3-CBL20 *
P3-16NA	20	Feedthrough	ZL-RTB20	ZL-P3-CBL20 *L
P3-16ND3	20	Feedthrough	ZL-RTB20	ZL-P3-CBL20 *L
		Sensor	ZL-LTB16-24-1	ZL-P3-CBL20 *L
P3-32ND3	40	Feedthrough	ZL-RTB40	ZL-CBL40 *
		Sensor	ZL-LTB32-24-1	ZL-CBL40 *
P3-64ND3 ¹	40	Feedthrough	ZL-RTB40	ZL-CBL40 *
		Sensor	ZL-LTB32-24-1	ZL-CBL40 *

Productivity3000 CPU Analog In Module ZIPLink Selector				
CPU		ZIPLink		
Analog Module	# of Terms	Component	Module	Cable
P3-04ADS	20	Feedthrough	ZL-RTB20	ZL-P3-CBL20 *L
P3-08AD	20	Feedthrough	ZL-RTB20	ZL-P3-CBL20 *L
P3-16AD-1	20	Feedthrough	ZL-RTB20	ZL-P3-CBL20 *L
P3-16AD-2	20	Feedthrough	ZL-RTB20	ZL-P3-CBL20 *L
P3-08RTD ²	Matched Only	See Note 2		
P3-08THM ²	T/C Wire Only	See Note 2		
P3-04DA	20	Feedthrough	ZL-RTB20	ZL-P3-CBL20 *L
P3-08DA-1	20	Feedthrough	ZL-RTB20	ZL-P3-CBL20 *L
P3-08DA-2	20	Feedthrough	ZL-RTB20	ZL-P3-CBL20 *L
P3-06DAS-1	20	Feedthrough	ZL-RTB20	ZL-P3-CBL20 *L
P3-06DAS-2	20	Feedthrough	ZL-RTB20	ZL-P3-CBL20 *L
P3-16DA-1	20	Feedthrough	ZL-RTB20	ZL-P3-CBL20 *L
P3-16DA-2	20	Feedthrough	ZL-RTB20	ZL-P3-CBL20 *L
P3-8AD4DA-1	20	Feedthrough	ZL-RTB20	ZL-P3-CBL20 *L
P3-8AD4DA-2	20	Feedthrough	ZL-RTB20	ZL-P3-CBL20 *L

Productivity3000 CPU Specialty Module ZIPLink Selector				
CPU		ZIPLink		
Input Module	# of Terms	Component	Module Part No.	Cable Part No.
P3-HSI	40	Feedthrough	ZL-RTB40	ZL-CBL40-S
P3-HSO				ZL-CBL40-1S ZL-CBL40-2S



NOTE: ZIPLINK CONNECTOR MODULES SPECIFICATIONS FOLLOW THE COMPATIBILITY MATRIX TABLES. ZIPLINK CABLES SPECIFICATIONS ARE AT THE END OF THIS ZIPLINK SECTION.

Productivity3000 CPU Output Module ZIPLink Selector				
CPU		ZIPLink		
Output Module	# of Terms	Component	Module Part No.	Cable Part No.
P3-08TAS	20	Feedthrough	ZL-RTB20	ZL-P3-CBL20 *
P3-08TD1S	20	Feedthrough	ZL-RTB20	ZL-P3-CBL20 *L
P3-08TD2S	20	Feedthrough	ZL-RTB20	ZL-P3-CBL20 *L
P3-08TRS	20	Feedthrough	ZL-RTB20	ZL-P3-CBL20 *
P3-16TA	20	Feedthrough	ZL-RTB20	ZL-P3-CBL20 *
		Fuse	ZL-RFU20	ZL-P3-CBL20 *
P3-16TD1	20	Feedthrough	ZL-RTB20	ZL-P3-CBL20 *
		Fuse	ZL-RFU20 ⁴	ZL-P3-CBL20 *
		Relay (sinking)	ZL-RRL16-24-1	ZL-P3-CBL20 *
P3-16TD2	20	Feedthrough	ZL-RTB20	ZL-P3-CBL20 *
		Fuse	ZL-RFU20 ⁴	ZL-P3-CBL20 *
		Relay (sourcing)	ZL-RRL16-24-2	ZL-P3-CBL20
P3-16TR	20	Feedthrough	ZL-RTB20	ZL-P3-CBL20 *
		Fuse	ZL-RFU20 ⁴	ZL-P3-CBL20 *
P3-08TRS-1 ³	20	Feedthrough	ZL-RTB20	ZL-P3-CBL20 *
		Fuse	ZL-RFU20 ⁴	ZL-P3-CBL20 *
P3-32TD1	40	Feedthrough	ZL-RTB40	ZL-CBL40 *
		Fuse	ZL-RFU40 ⁴	ZL-CBL40 *
P3-32TD2	40	Feedthrough	ZL-RTB40	ZL-CBL40 *
		Fuse	ZL-RFU40 ⁴	ZL-CBL40 *
P3-64TD1 ¹	40	Feedthrough	ZL-RTB40	ZL-CBL40 *
		Fuse	ZL-RFU40 ⁴	ZL-CBL40 *
P3-64TD2 ¹	40	Feedthrough	ZL-RTB40	ZL-CBL40 *
		Fuse	ZL-RFU40 ⁴	ZL-CBL40 *
P3-16TD3P	40	Feedthrough	ZL-RTB40	ZL-CBL40 *

* Select the cable length by replacing the * with: Blank = 0.5m, -1 = 1.0m, or -2 = 2.0m.

¹ The P3-64ND3, P3-64TD1 and P3-64TD2 modules have two 32-point connectors and require two ZIPLink cables and two ZIPLink connector modules.

² These modules are not supported by the ZIPLink wiring system.

³ The P3-08TRS-1 output module is derated not to exceed 2A per point maximum when used with the ZIPLink wiring system.

⁴ Note: Fuses (5 x 20 mm) are not included. See Edison Electronic Fuse section for (5 x 20 mm) fuse. S500 and GMA electronic circuit protection for fast-acting maximum protection. S506 and GMC electronic circuit protection for time-delay performance. Ideal for inductive circuits.

To ensure proper operation, do not exceed the voltage and current rating of ZIPLink module. ZL-RFU20 = 2A per circuit; ZL-RFU40 = 400 mA per circuit.



I/O Modules

A variety of discrete, analog and specialty I/O modules are available for use in local, expansion, and remote I/O bases. Specifications for each module are on the following pages.

A filler module is available for unused I/O module slots (part number P3-FILL).

Discrete Input Modules

Productivity3000 Discrete Input Modules			
Part Number	Number of Inputs	Description	Price
P3-16SIM	16	Input Simulator Module	
P3-08ND3S	8	Isolated Sinking/Sourcing DC Input	
P3-16ND3	16	Sinking/Sourcing DC Input	
P3-32ND3	32	Sinking/Sourcing DC Input	
P3-64ND3	64	Sinking/Sourcing DC Input	
P3-08NAS	8	Isolated AC Input	
P3-16NA	16	AC Input	

*ZIPLink required.

Analog I/O Modules

Productivity3000 Analog Input Modules			
Part Number	Number of Channels	Description	Price
P3-04ADS	4	Isolated Analog Input	
P3-08AD	8	Analog Input	
P3-16AD-1	16	Analog Input (Current)	
P3-16AD-2	16	Analog Input (Voltage)	
P3-08RTD	8	Analog RTD Input	
P3-08THM	8	Analog Thermocouple Input	

Productivity3000 Analog Output Modules			
Part Number	Number of Channels	Description	Price
P3-04DA	4	Analog Output	
P3-08DA-1	8	Analog Output (Current)	
P3-08DA-2	8	Analog Output (Voltage)	
P3-06DAS-1	6	Isolated Analog Output (Current)	
P3-06DAS-2	6	Isolated Analog Output (Voltage)	
P3-16DA-1	16	Analog Output (Current)	
P3-16DA-2	16	Analog Output (Voltage)	

Productivity3000 Analog Input/Output Modules			
Part Number	Number of Channels	Description	Price
P3-8AD4DA-1	8/4	Analog Input/Output (Current)	
P3-8AD4DA-2	8/4	Analog Input/Output (Voltage)	

Specialty Modules

Productivity3000 Specialty Modules			
Part Number	Number of Channels	Description	Price
P3-HSI	2	High-Speed Pulse Input	
P3-HSO*	2	High-Speed Output	
P3-SCM	4 ports	Serial Communications Module	

*ZIPLink required.

Discrete Output Modules

Productivity3000 Discrete Output Modules			
Part Number	Number of Outputs	Description	Price
P3-08TD1S	8	Isolated Sinking Output	
P3-08TD2S	8	Isolated Sourcing Output	
P3-16TD1	16	Sinking Output	
P3-16TD2	16	Sourcing Output	
P3-32TD1*	32	Sinking Output	
P3-32TD2*	32	Sourcing Output	
P3-64TD1*	*64	Sinking Output	
P3-64TD2*	*64	Sourcing Output	
P3-08TAS	8	Isolated AC Output	
P3-16TA	16	AC Output	
P3-08TRS	8	Isolated Relay Output	
P3-08TRS-1	8	Isolated Relay Output	
P3-16TR	16	Relay Output	
P3-16TD3P*	16	Sinking/Sourcing Protected Output	

*ZIPLink required.

Module Installation Procedure



WARNING: Do not apply field power until the following steps are completed. See hot-swapping procedure for exceptions.

Step One: Align circuit card with slot and press firmly to seat module into connector.

Step Two: Pull top and bottom locking tabs toward module face. Click indicates lock is engaged.

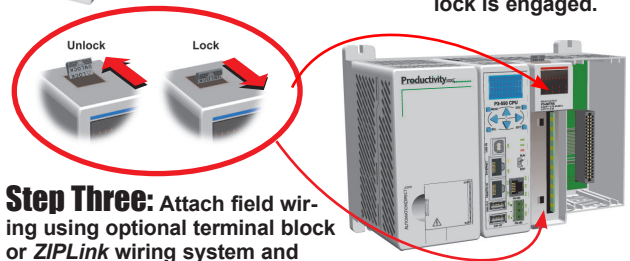

Step Three: Attach field wiring using optional terminal block or ZIPLink wiring system and install cover.

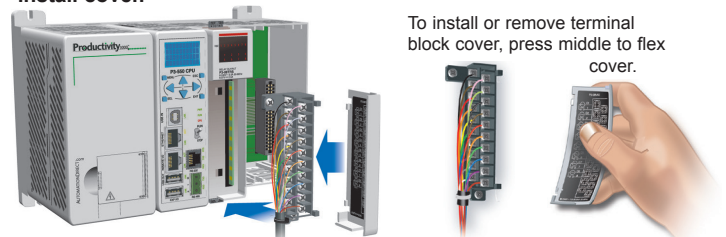

WARNING: Explosion hazard – Do not connect or disconnect connectors or operate switches while circuit is live unless the area is known to be non-hazardous. Do not hot-swap modules unless the area is known to be non-hazardous.