

# Remote Slave Modules

## P3-RS

## P3-RX

The P3-RS and P3-RX are high-performance Remote Slave modules (for use with P3-550 CPU-based systems only). Both modules have several communications ports which support USB Expansion I/O, Ethernet Remote I/O and serial devices. The P3-RS also includes a 4 line x 10 character LCD display and an additional USB IN (type B) port for remote CPU programming and monitoring.

Up to 16 Remote Slaves can be connected to a single CPU for a remote I/O network.

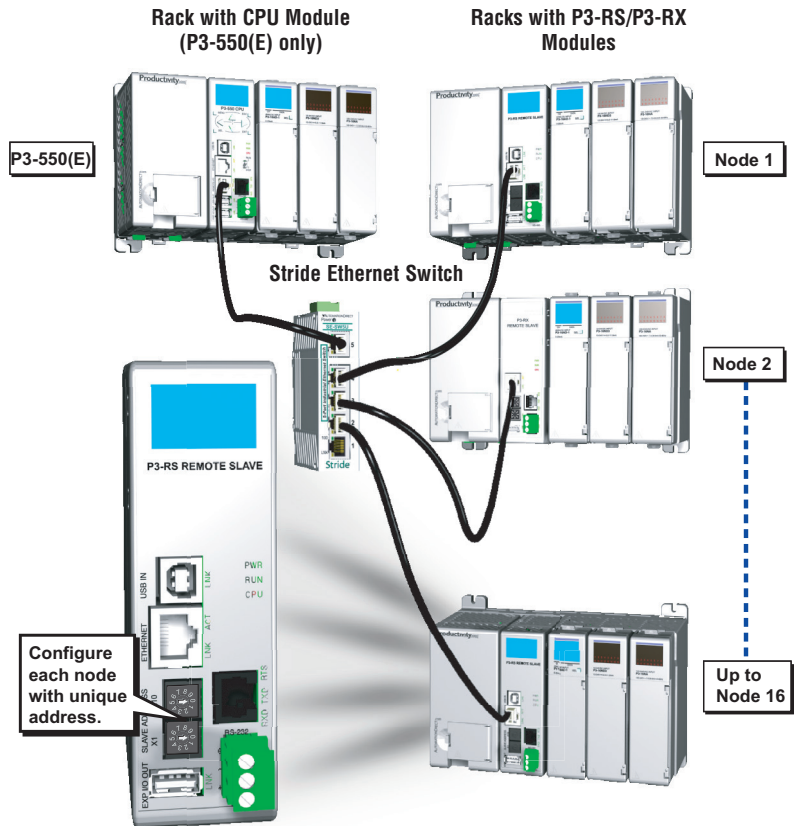
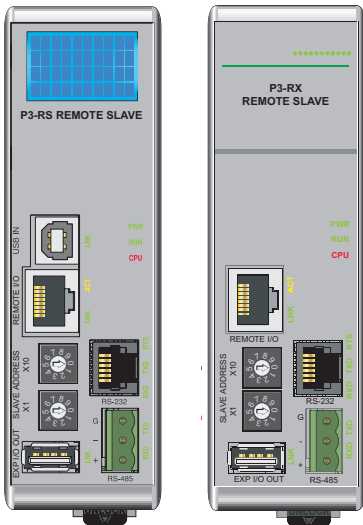

Add up to 16 Remote Base Groups using P3-RS or P3-RX Remote Slave modules and up to 32 GS Drives on the Remote I/O Ethernet Network (P3-550(E) only).

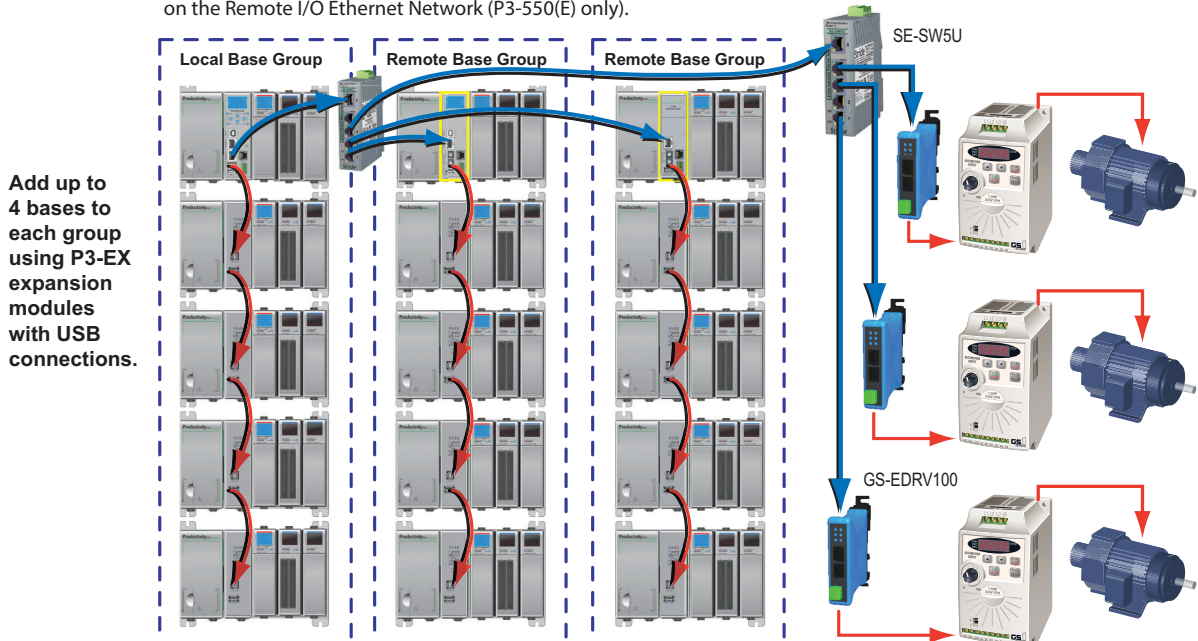

# Remote Slave Modules

## Remote Slave Specifications (for P3-550(E))











Mounting Location	Controller slot
Display (P3-RS only)	LCD, 4x10 characters, backlit, LCD characters are 5x7 with a dot pitch of 0.45 mm; 2.25 mm x 3.15 mm
Communications	<b>USB IN:</b> (2.0, Type B) Programming, Monitoring, Debug (P3-RS Only) <b>REMOTE I/O:</b> (10/100 Mbps Ethernet) 1 P3-550 <b>EXP I/O OUT:</b> (2.0, Type A, Proprietary) 4 P3-EX Local Expansion Bases <b>RS-232:</b> (RJ12, 1200–115.2k bps) ASCII, Modbus <b>RS-485:</b> (Removable Terminal Included, 1200–115.2k baud) ASCII, Modbus
Max. Number of Ethernet Remote I/O Bases	16
Max. Number of Expansion I/O Bases	68 (4 per CPU, 4 per Remote Base)
Max. Number of I/O per CPU System	59,840 (CPU Base with 4 Expansion Bases plus 16 Remote Bases with 4 Expansion Bases per Remote, with 11 64-point I/O modules per base)

## General Specifications

Operating Temperature	0°C–60°C (32°F–140°F)
Storage Temperature	-20°C–70°C (-4°F–158°F)
Humidity	5 to 95% (non-condensing)
Environmental Air	No corrosive gases permitted
Vibration	IEC60068-2-6 (Test Fc)
Shock	IEC60068-2-27 (Test Ea)
Heat Dissipation	4W
Enclosure Type	Open equipment
Module Location	Controller slot in a remote base in a Productivity3000 system
Weight	260g (9 oz)
Agency Approvals	UL508 file E157382, Canada & USA UL1604 file E200031, Canada & USA CE (EN61131-2*) This equipment is suitable for use in Class 1, Division 2, Groups A, B, C and D or non-hazardous locations only.

\*Meets EMC and Safety requirements. See the Declaration of Conformity for details.

## P3-RS/P3-RX Product Comparison

remote I/O module	P3-RS	P3-RX
LCD Display		
USB Prog/Mon Port		
Remote Port (in)		
USB Local Expansion Port		
RS-232 RJ12 Port		
RS-485 Port		

## IMPORTANT!



### Hot-Swapping Information

**Note:** This device cannot be Hot Swapped.

**WARNING:** Explosion hazard – Substitution of components may impair suitability for Class 1, Division 2.



**NOTE:** When using the P3-RX, you must use Productivity3000® software version 1.0.7.XX and firmware version 1.1.13.XX or later.

# Remote Slave Modules

## Front Panel

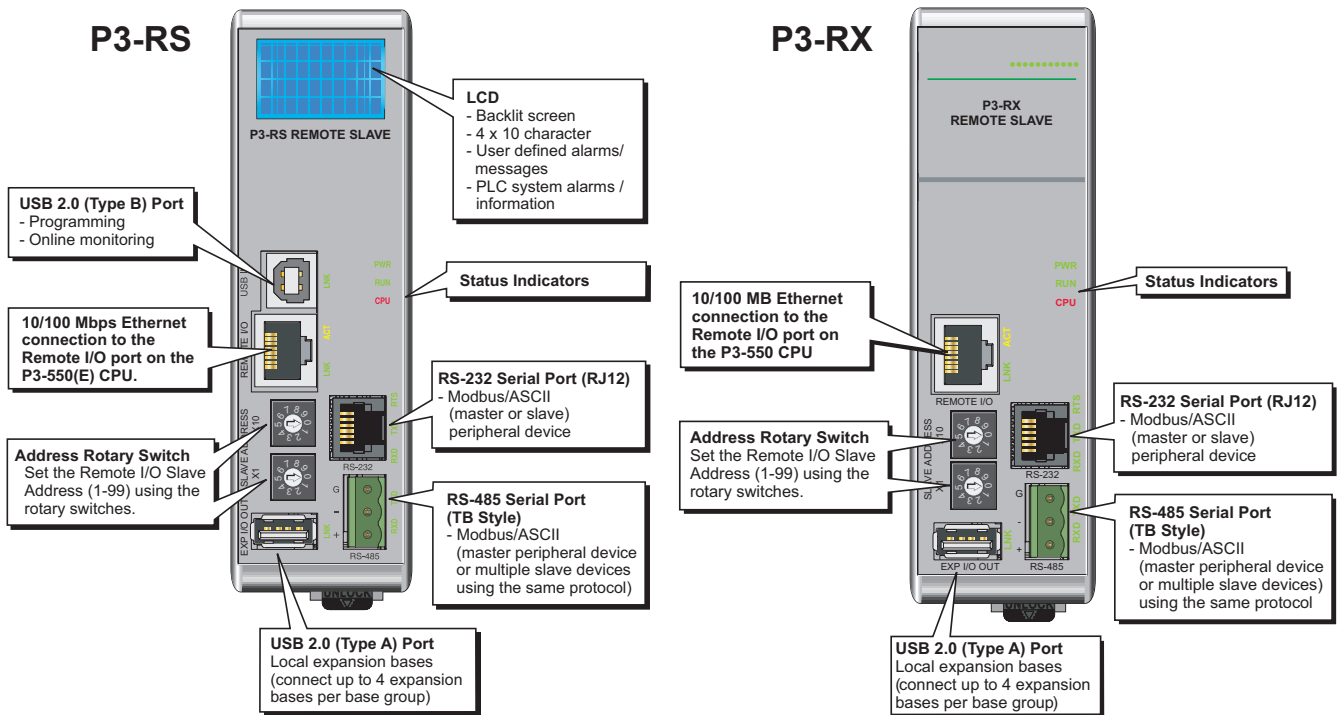

## LCD (P3-RS only)

The P3-RS incorporates a 4 line x 10 character LCD for system errors and information or for displaying user-defined messages.

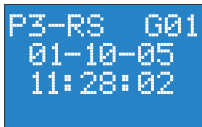

LCD characters are 5x7 with a dot pitch of 0.45 mm; 2.25 mm x 3.15 mm.

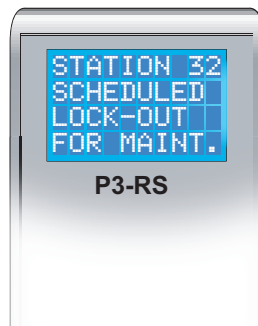
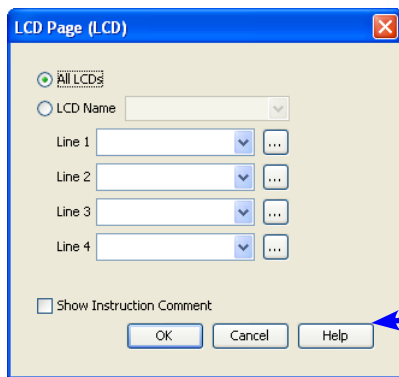

For user-defined messages, the display is configured using the Productivity Suite Programming Software. An LCD Page instruction allows the user to program text into user-defined tags and display the messages based on the ladder execution.

See the Productivity Suite Programming Software Help Files for complete details.

## Status Indicators

RS Status Indicators	
PWR	Green LED is backlit when power is on
RUN	Green LED is backlit when CPU is in RUN mode
CPU	Red LED is backlit during power on reset, power down, or watchdog time-out.

PWR  
RUN  
CPU

# Remote Slave Modules

## Setting the Remote Slave Address

Each Remote Slave must have a unique address between 1 and 99. The address is set using the two rotary switches located on the face of the module, X10 for setting the tens units and X1 for setting the ones unit.

For example, to set a remote slave address to 21, turn the X10 arrow until it points at number 2 and the X1 arrow until it points at number 1.

### IMPORTANT NOTES:

- The factory setting of 00 is not a valid address.
- Address selection must be set prior to power-up.
- Slave addresses are only read on power-up.
- If there are duplicate slave addresses on the same network, a critical error will occur.

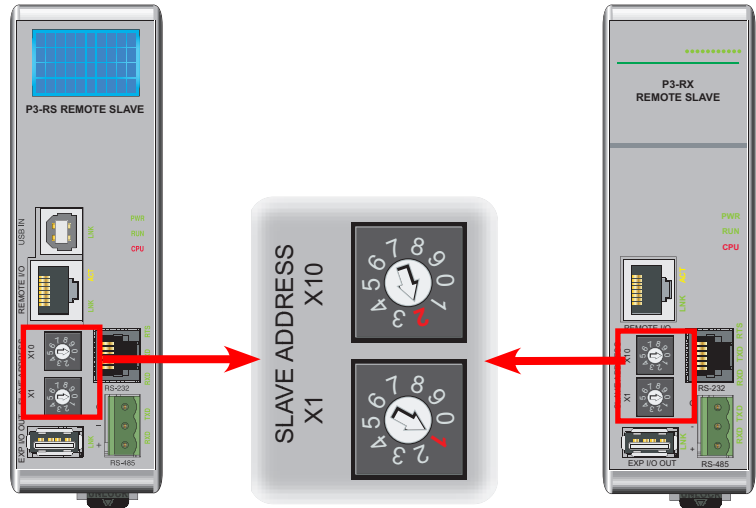

It is also necessary to configure the remote addresses using the Productivity Suite Programming Software.

This can be done automatically by first going online with a Productivity3000 system that has slave modules installed, go to Hardware Configuration and select the Read Configuration (1) button. The CPU will automatically read the addresses of the remote slaves and add them to the configuration.

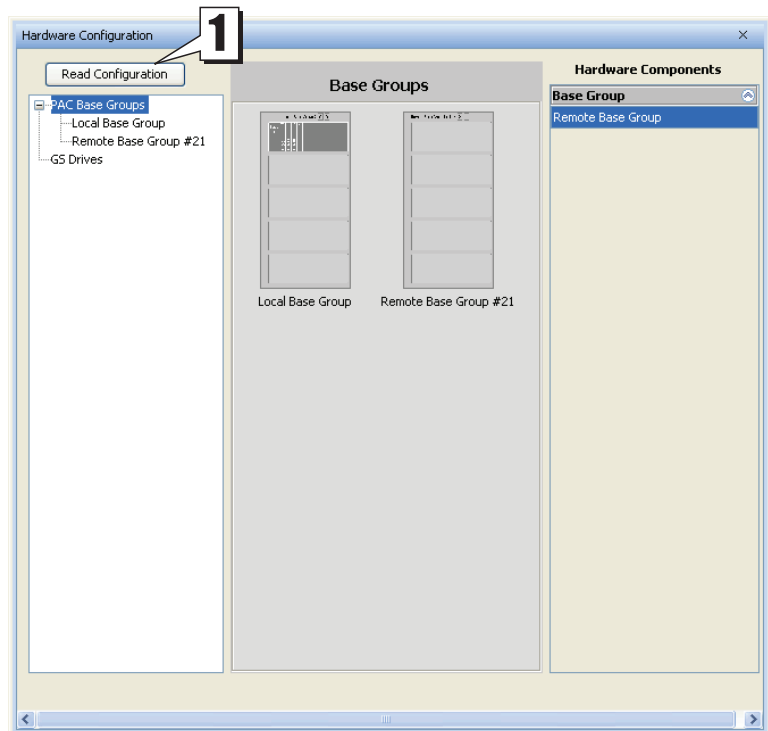

# Remote Slave Modules

## Port Specifications

The P3-RS and P3-RX have several communications ports. The following pages have specifications and pin-out diagrams for these ports.

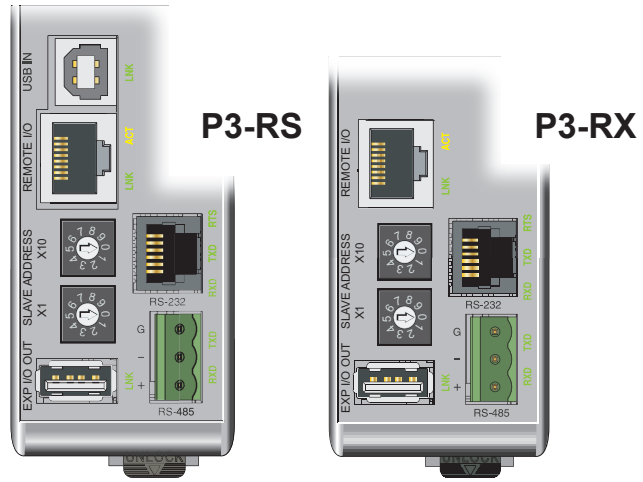

### USB IN Port (P3-RS only)

Standard USB 2.0 (Type B) Slave input for remote CPU programming and online monitoring, with built-in surge protection.

USB IN Specifications	
Description	Standard USB 2.0 (Type B) Slave input for remote CPU programming and online monitoring, with built-in surge protection. Not compatible with older full speed USB devices.
Transfer Rate	480 Mbps
Port Status LED	Green LED is illuminated when LINK is established to programming software.
Cables	USB Type A to USB Type B: 3ft cable part # USB-CBL-AB3 6ft cable part # USB-CBL-AB6 10ft cable part # USB-CBL-AB10 15ft cable part # USB-CBL-AB15

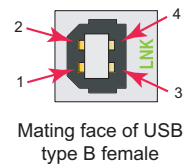

Pin #	Signal
1	+5
2	-Data
3	+Data
4	GND

### Remote I/O Port

Isolated Ethernet Port with built-in surge protection for connection to P3-550 CPU Remote I/O Master port.

Remote I/O Port Specifications	
Description	Proprietary transformer isolated Ethernet Port with built-in surge protection for connection to CPU Remote I/O Master port.
Transfer Rate	10/100 Mbps
Port Status LEDs	Green LED is illuminated when network LINK is established. Yellow LED backlit when port is active (ACT).
Cables	Use a Patch (straight-through) cable when a switch or hub is used. Use a Crossover cable when a switch or hub is not used. (Cables available at automationdirect.com)

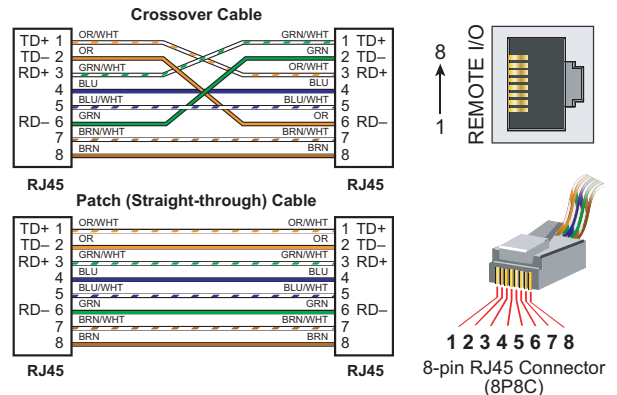

# Remote Slave Modules

## EXP I/O OUT Port

USB 2.0 (Type A) Master output for connection to up to four P3-EX local expansion bases, with built-in surge protection.

### EXP I/O OUT Specifications

Description	Proprietary USB 2.0 (Type A) Master output for connection with up to four P3-EX local expansion bases, with built-in surge protection.
Transfer Rate	480 Mbps
Port Status LED	Green LED is illuminated when LINK is established to connected device
Cables	USB Type A to USB Type B. The P3-EX Expansion Module includes a 6 foot USB cable, part number P3-EX-CBL6.

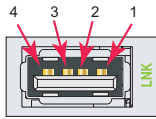

Mating face of USB type A female

Pin #	Signal
1	Reset
2	- Data
3	+ Data
4	GND

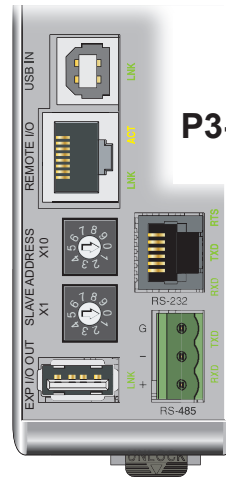

P3-RS

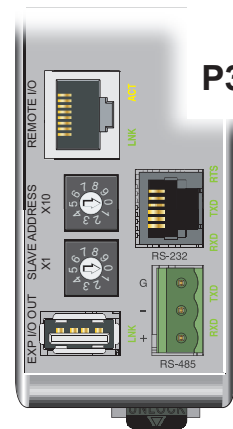

P3-RX

## RS-232 Serial Port

Non-isolated RS-232 DTE port connects the P3-RS/P3-RX as a Modbus or ASCII master or slave to a peripheral device.

### RS-232 Specifications

Description	Non-isolated RS-232 DTE port connects the P3-RS/P3-RX as a Modbus or ASCII master or slave to a peripheral device. Includes ESD and built-in surge protection.
Data Rates	Selectable, 1200, 2400, 9600, 19200, 33600, 38400, 57600, and 115200 baud.
+5V Cable Power Source	210mA maximum at 5V, ±5%. Limited by self-resetting current limiting device. Reverse polarity protected.
TXD	RS-232 Transmit output
RXD	RS-232 Receive input
RTS	Handshaking output for modem control.
GND	Logic ground
Maximum Output Load (TXD/RTS)	3kΩ, 1,000pf
Minimum Output Voltage Swing	±5V
Output Short Circuit Protection	±15mA
Port Status LED	Green LED is illuminated when active for TXD, RXD and RTS
Cable Options	FA-ISOCOON for converting RS-232 to isolated RS-485

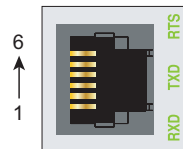

6-pin RJ12 Female Modular Connector

Pin #	Signal
1	GND Logic Ground
2	+5V 210 mA Maximum
3	RXD RS-232 Input
4	TXD RS-232 Output
5	RTS Request to Send
6	GND Logic Ground

# Remote Slave Modules

## RS-485 Serial Port

Non-isolated RS-485 port connects the P3-RS or P3-RX as a Modbus or ASCII master or slave to a peripheral device. (Removable connector included.)

RS-485 Specifications	
Description	Non-isolated RS-485 port connects the P3-RS/P3-RX as a Modbus or ASCII master or slave to a peripheral device. Includes ESD/EFT protection and automatic echo cancellation when transmitter is active.
Data Rates	Selectable, 1200, 2400, 9600, 19200, 33600, 38400, 57600, and 115200 bps.
TXD+/RXD+	RS-485 transceiver high
TXD-/RXD-	RS-485 transceiver low
GND	Logic ground
Input Impedance	19kΩ
Maximum load	50 transceivers, 19kΩ each, 60Ω termination
Output Short Circuit Protection	±250mA, thermal shut-down protection
Electrostatic Discharge Protection	±8kV per IEC1000-4-2
Electrical Fast Transient Protection	±2kV per IEC1000-4-4.
Minimum Differential Output Voltage	1.5 V with 60Ω load
Fail safe inputs	Logic high input state if inputs are unconnected
Maximum Common Mode Voltage	-7.5 V to 12.5 V.
Port Status LED	Green LED is illuminated when active for TXD and RXD
Cable Options	L19827-100 L19827-500 L19827-1000 Belden 9841 equivalent

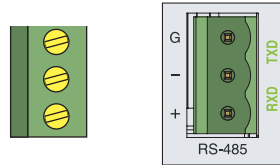
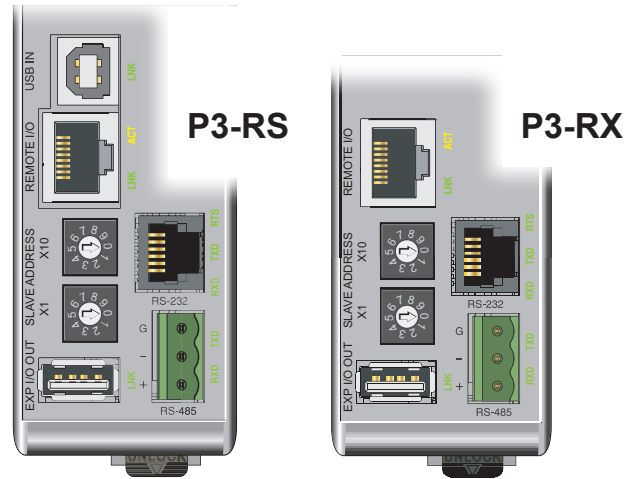

Pin #	Signal
G	GND
-	TXD-/RXD-
+	TXD+/RXD+

\*Removable connector included.

Terminal Block Specifications	
Number of Positions	3
Pitch	5mm
Wire Range	28–12 AWG Solid Conductor 30–12 AWG Stranded Conductor
Screw Driver Width	1/8 inch (3.175 mm) maximum
Screw Size	M2.5
Screw Torque	4.5 lb-in (0.51 N-m)

## Installation Procedure

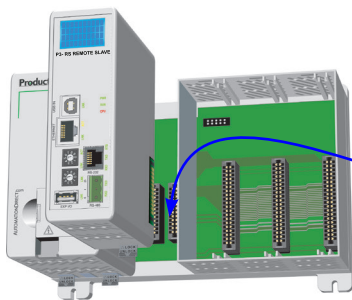

**Step One:**  
Locate the two sockets next to the power supply; the module will be inserted into this location.

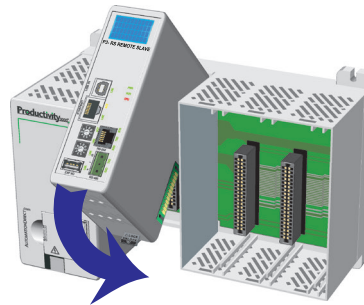

**Step Two:**  
Insert at a 45° angle into the notch located at the top of the base and rotate down until seated.



**Step Three:**  
Snap retaining tab into the locked position.

**WARNING:** Explosion hazard – Do not connect or disconnect connectors or operate switches while circuit is live unless the area is known to be non-hazardous. Do not hot swap.