

PS Series Fork Sensors

Fork Sensor U-frame - Visible Red Light



- Rugged metal one-piece housing - always in alignment
- Easy installation
- Visible red light - easy setup
- Glass optics
- High resolution
- Light / Dark operation selectable
- Adjustable sensitivity
- High switching frequency
- M8 connector with 360° LED



PS Series Fork Sensor U-frame Selection Chart - Visible Red Light							
Part Number	Price	Sensing Range	Output State	Logic	Connection	Wiring	Dimensions
PSUR-0P-1F		5mm (0.2 in)	Light On/Dark On Selectable	PNP	M8 connector	Diagram 2	Figure 1
PSUR-0N-1F		5mm (0.2 in)	Light On/Dark On Selectable	NPN	M8 connector	Diagram 1	Figure 1
PSUR-0P-2F		10mm (0.39 in)	Light On/Dark On Selectable	PNP	M8 connector	Diagram 2	Figure 2
PSUR-0N-2F		10mm (0.39 in)	Light On/Dark On Selectable	NPN	M8 connector	Diagram 1	Figure 2
PSUR-0P-3F		20mm (0.79 in)	Light On/Dark On Selectable	PNP	M8 connector	Diagram 2	Figure 3
PSUR-0N-3F		20mm (0.79 in)	Light On/Dark On Selectable	NPN	M8 connector	Diagram 1	Figure 3
PSUR-0P-4F		30mm (1.18 in)	Light On/Dark On Selectable	PNP	M8 connector	Diagram 2	Figure 4
PSUR-0N-4F		30mm (1.18 in)	Light On/Dark On Selectable	NPN	M8 connector	Diagram 1	Figure 4
PSUR-0P-5F		50mm (1.97 in)	Light On/Dark On Selectable	PNP	M8 connector	Diagram 2	Figure 5
PSUR-0N-5F		50mm (1.97 in)	Light On/Dark On Selectable	NPN	M8 connector	Diagram 1	Figure 5
PSUR-0P-6F		80mm (3.15 in)	Light On/Dark On Selectable	PNP	M8 connector	Diagram 2	Figure 6
PSUR-0N-6F		80mm (3.15 in)	Light On/Dark On Selectable	NPN	M8 connector	Diagram 1	Figure 6
PSUR-0P-7F		120mm (4.72 in)	Light On/Dark On Selectable	PNP	M8 connector	Diagram 2	Figure 7
PSUR-0N-7F		120mm (4.72 in)	Light On/Dark On Selectable	NPN	M8 connector	Diagram 1	Figure 7
PSUR-0P-8F		180mm (7.09 in)	Light On/Dark On Selectable	PNP	M8 connector	Diagram 2	Figure 8
PSUR-0N-8F		180mm (7.09 in)	Light On/Dark On Selectable	NPN	M8 connector	Diagram 1	Figure 8
PSUR-0P-9F		220mm (8.66 in)	Light On/Dark On Selectable	PNP	M8 connector	Diagram 2	Figure 9
PSUR-0N-9F		220mm (8.66 in)	Light On/Dark On Selectable	NPN	M8 connector	Diagram 1	Figure 9

Wiring diagrams

Diagram 1

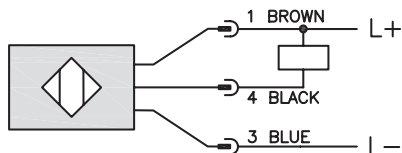
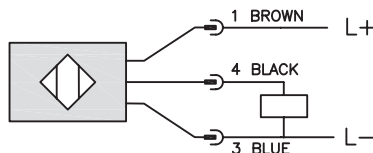
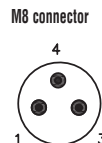

Diagram 2



Connectors



NOTE: CLASS 2 POWER SUPPLY REQUIRED

PS Series Fork Sensors

Specifications		
	U-frame - Visible Red Light	U-frame Frame - Infrared Light
Mounting Type	Slot	
Sensing Distance	5.0 mm (0.20 in) to 220mm (8.66 in)	
Smallest Detectable Object	PSUR 1F–2F–3F–4F 0.3 mm (0.012 in) PSUR 5F–6F 0.4 mm (0.016 in) PSUR 7F 0.5 mm (0.020 in) PSUR 8F–9F 0.6 mm (0.024 in)	PSUI 1F–2F–3F–4F 0.8 mm (0.032 in) PSUI 5F 1.0 mm (0.040 in) PSUI 6F 1.2 mm (0.047 in) PSUI 7F–8F–9F 1.5 mm (0.059 in)
Emission	Visible Red Light	Infrared Light
Sensitivity	Adjustable Potentiometer (0 to 270°)	
Output Type	NPN or PNP/ Light on/Dark on/ 3-wire	
Operating Voltage	10 to 30 VDC	
No-load Supply Current	≤ 35 mA	
Operating (Load) Current	200 mA	
Off-state (Leakage) Current	N/A	
Voltage Drop	≤ 3.0V (PNP); ≤2.5 (NPN)	
Switching Frequency	PSUR 1F–2F 3 kHz PSUR 3F–9F 1.5 kHz	PSUI 1F–2F 3 kHz PSUI 3F–4F–5F–6F–8F–9F 2 kHz PSUI 7F 1kHz
Differential Travel	N/A	
Repeat Accuracy	PSUR 1F–2F–3F–4F 0.02 mm (0.0008 in) PSUR 5F 0.04 mm (0.0016 in) PSUR 6F 0.06 mm (0.0024 in) PSUR 7F–8F–9F 0.08 mm (0.0031 in)	PSUI 1F–2F–3F–4F 0.1 mm (0.0039 in) PSUI 5F 0.12 mm (0.0047 in) PSUI 6F 0.15 mm (0.0059 in) PSUI 7F–8F–9F 0.2 mm (0.0079 in)
Ripple	N/A	
Time Delay Before Availability (tv)	N/A	
Reverse Polarity Protection	Yes	
Short-Circuit Protection	Yes	
Operating Temperature	-10°C to +60°C (14°F to +140°F)	
Protection Degree (DIN 40050)	IP67	
Indication/Switch Status	On Yellow LED	
Housing Material	GD Zn (Gadolinium-Zinc)	
Sensing Face Material	Glass	
Shock	Meets IEC 68-2-27 (See Photoelectric Sensor Terminology at the end of this section for more details)	
Vibration	Meets IEC 68-2-6 (See Photoelectric Sensor Terminology at the end of this section for more details)	
Tightening Torque	N/A	
Weight	PSUx 1F 20g (0.71 oz) PSUx 2F 23g (0.81 oz) PSUx 3F 28g (0.99 oz) PSUx 4F 36g (1.27 oz) PSUx 5F 54g (1.90 oz) PSUx 6F 77g (2.72 oz) PSUx 7F 118g (4.16 oz) PSUx 8F 190g (6.70 oz) PSUx 9F 220g (7.76 oz)	
Connection	M8 connector	
Agency Approvals	UL E328811– CE	

Note: To obtain the most current agency approval information– see the Agency Approval Checklist section on the specific part number's web page.

PS Series Fork Sensors

Dimensions

mm
[inch]

Figure 1

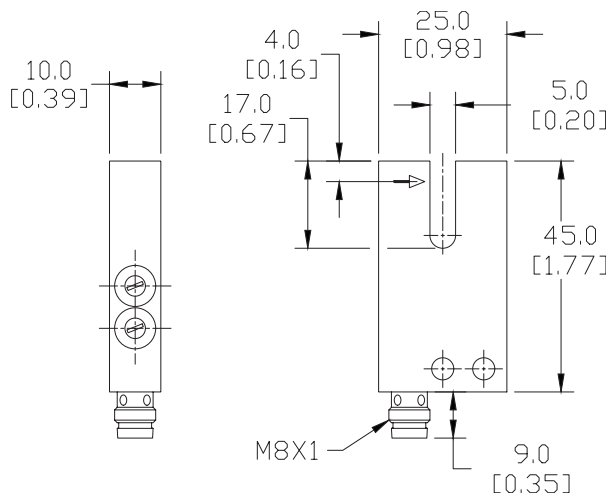

Figure 2

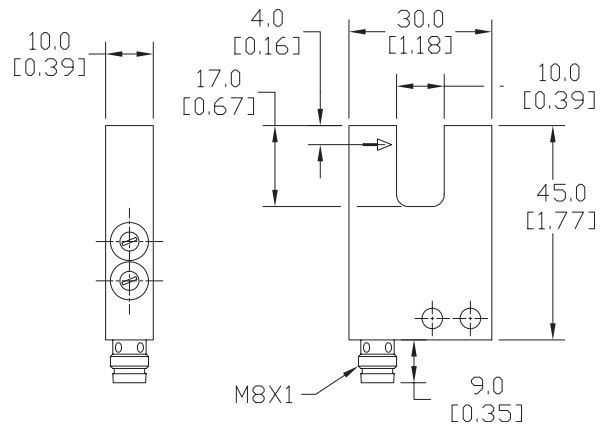

Figure 3

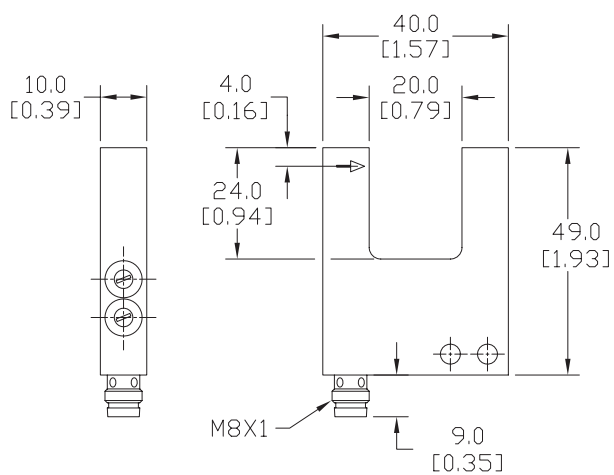
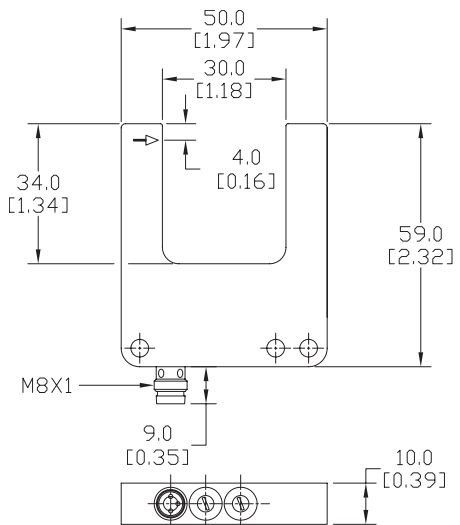

Figure 4



SEE OUR WEBSITE: WWW.AUTOMATIONDIRECT.COM FOR COMPLETE ENGINEERING DRAWINGS.

PS Series Fork Sensors

Dimensions

mm

[inch]

Figure 5

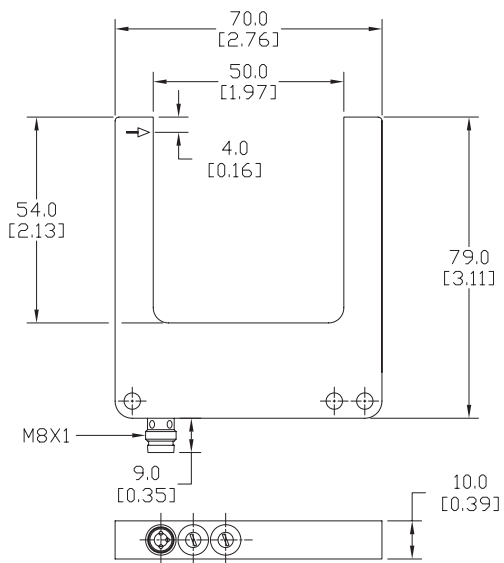

Figure 6

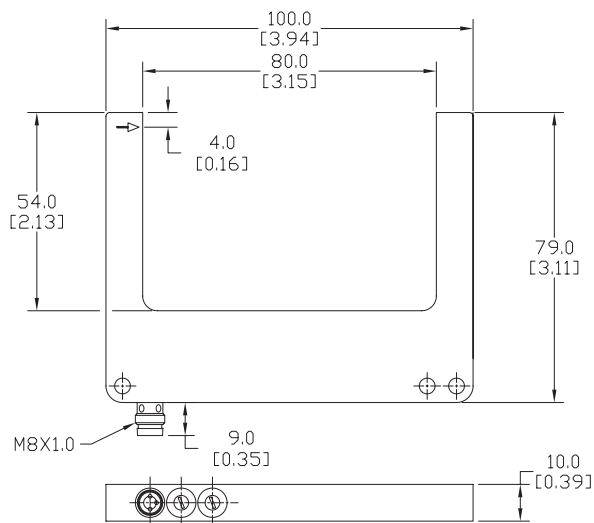
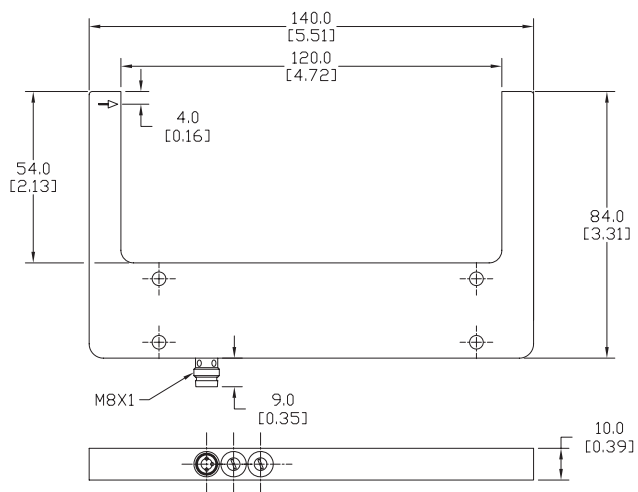

Figure 7



SEE OUR WEBSITE: WWW.AUTOMATIONDIRECT.COM FOR COMPLETE ENGINEERING DRAWINGS.

PS Series Fork Sensors

Dimensions

mm
[inch]

Figure 8

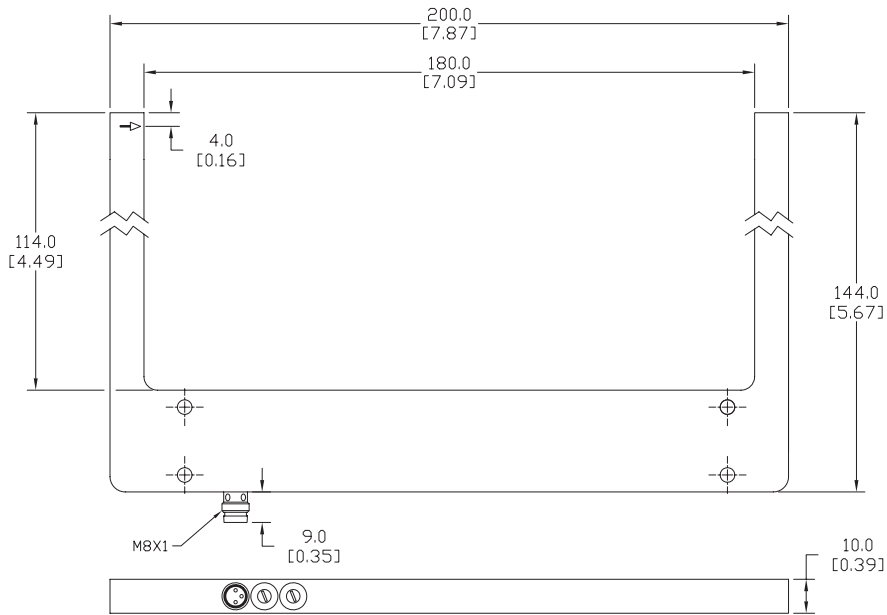
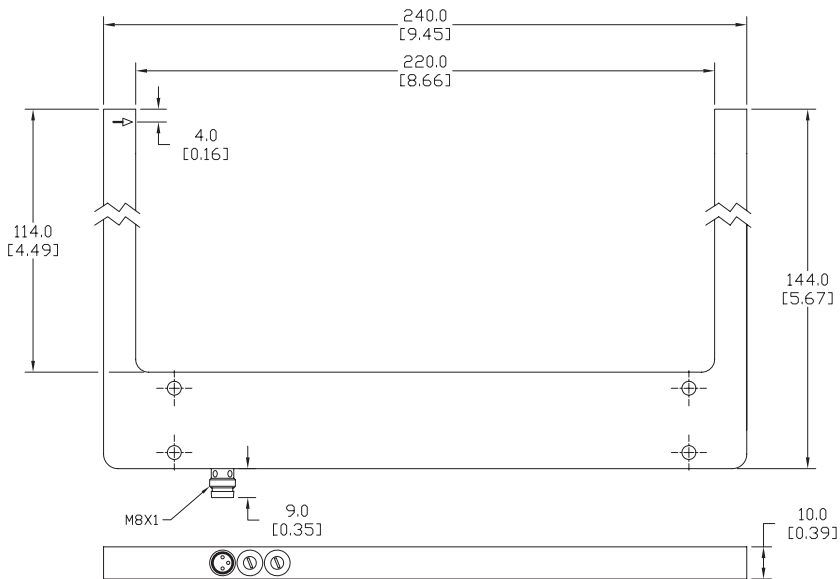

Figure 9



SEE OUR WEBSITE: WWW.AUTOMATIONDIRECT.COM FOR COMPLETE ENGINEERING DRAWINGS.