

# RHINO PSL-24-BCM240 BATTERY CONTROL MODULE

**READ INSTRUCTIONS BEFORE INSTALLING OR OPERATING THIS DEVICE. KEEP FOR FUTURE REFERENCE.**

## General Description

The PSL-24-BCM240 battery control module is designed to use in small cabinets where space is very critical. It requires less installation space due to its flat body with depth of only 55.6 mm, 71mm wide and 91mm tall. The tough plastic case is flame retardant, certified to UL 94V-0 specification. The module supports 24VDC systems with external battery up to 12AH capacity and comes with contacts for battery management signals and an LED indicator for battery status. The highly efficient convection cooled design is certified to major safety approvals including IEC/EN/UL 60950-1 for ITE and UL 508 for Industrial, which allows the module to be used reliably in most industrial applications.

## IMPORTANT SAFETY INSTRUCTIONS

- Retain these instructions. This manual contains important safety instructions.
- When replacing batteries, only use the same type of batteries as described in the Specifications.
- Proper disposal of batteries is required. Refer to the relevant local codes for disposal requirements.
- Switch main power off before connecting or disconnecting the device. Danger of explosion!
- If the orange status LED is on steady, this indicates a failure in the installation. In this case, do not turn on power supply while the battery is connected. Danger of explosion!
- To guarantee sufficient convection cooling, keep a distance of 20mm above and below the device as well as a lateral distance of 5mm to other units. See Figure 4.
- Please note that the enclosure of the device can become very hot depending on the ambient temperature and load of the power supply. Risk of burns!
- The mains power must be turned off before connecting or disconnecting wires to the terminals!
- Do not introduce any objects into the unit!
- Dangerous voltage present for at least 5 minutes after disconnecting all sources of power.
- This is a built-in unit and must be installed in a cabinet or room (condensation free environment and indoor location) that is relatively free of conductive contaminants.
- **CAUTION: FOR USE IN A CONTROLLED ENVIRONMENT.**



Risk of electrical shock, fire, personal injury or death.

1. Turn power off before working on the device.
2. Make sure the wiring is correct by following all local and national codes.
3. Do not modify or repair the unit.
4. Use caution to prevent any foreign objects from entering into the housing.
5. Do not use in wet locations.
6. Do not use the unit in area where moisture or condensation can be expected.



## Highlights & Features

- Suitable for 24V system up to 10A
- Zero switch over time from loss of DC input to battery operation
- Built-in diagnostic monitoring for DC OK, Discharge and Battery Fail by relay contacts
- Full power over entire operating temperature range from -20°C to +60°C
- LED indicators for DC OK, Battery Charging, Battery Discharging, Battery Fail and Battery Reverse Polarity
- High MTBF > 500,000 hrs. as per Telcordia SR-332
- Overvoltage, overcurrent, over temperature, short circuit protections
- Powered systems may include unbuffered loads

## Device description (Fig. 1)

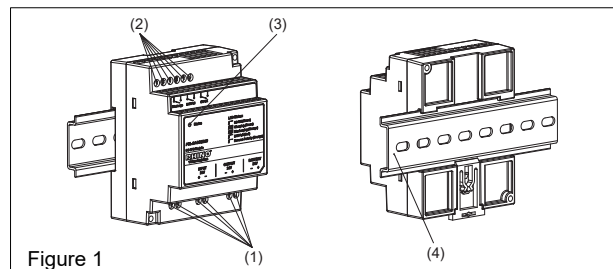

- Figure 1
- (1) Input/Output/Battery terminal block connector
  - (2) Signal terminal block connector
  - (3) LED display status
  - (4) Universal mounting rail system

**FOR TECHNICAL ASSISTANCE CALL**

RHINO PSL-24-BCM240 Battery Control Module

## Mounting

The unit can be mounted on 35mm DIN rails in accordance with EN60715. For vertical mounting, the device should be installed with Input/Output/Battery terminal block on the bottom.

Each device is delivered ready to install.

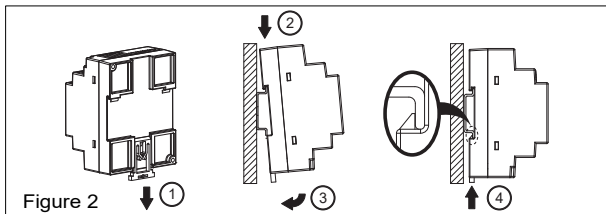

Snap on the DIN rail as shown in Fig. 2:

1. Pull the unit's DIN rail latch DOWN.
2. Tilt the unit slightly upwards, hook the top end onto the DIN rail and push downwards until stopped.
3. Position the bottom front end against the DIN rail.
4. Push the unit's latch DIN rail UP to lock.

## Dismounting

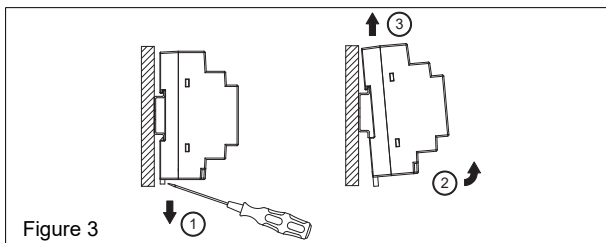

To uninstall:

1. Use a flat screwdriver to pull or slide down the latch as shown in Fig. 3.
2. Tilt the bottom part of the unit out.
3. Push the unit up and pull out from the DIN rail.

## Orientation

To guarantee sufficient convection cooling, keep a distance of 20mm (0.79 inch) above and below the device as well as a lateral distance of 5mm (0.2 inch) to other units.

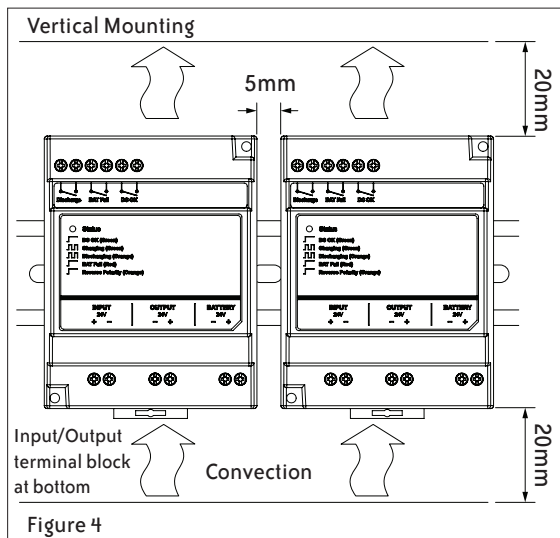

RHINO PSL-24-BCM240 Battery Control Module

## Connection

The terminal block connectors allow easy and fast wiring. You can use flexible (stranded wire) or solid cables as follows:

	Stranded / Solid		Torque	
	mm <sup>2</sup>	AWG	N-m	lb-in
In/Out/Battery	2.1-3.3	14-12	0.62	5.4
Signal	0.21-3.3	24-12	0.62	5.4

The wires between the battery control module and battery must not be longer than 2 x 2m (cord length 2m). For reliable and shock proof connections, the wire stripping length should be 7mm (see Fig. 5 (1)). Please ensure that wires are fully inserted into the connecting terminals as shown in Fig. 5 (2).

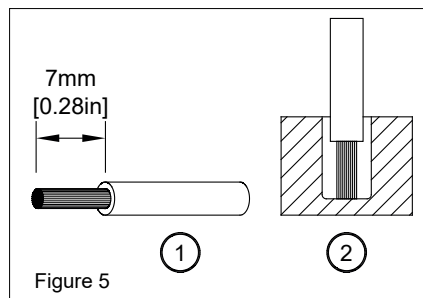

In accordance with EN60950 / UL60950, flexible cables require ferrules.

Use appropriate copper cables that are designed to sustain operating temperature of at least 60°C/75°C for USA or at least 90°C for Canada.

## Power Derating

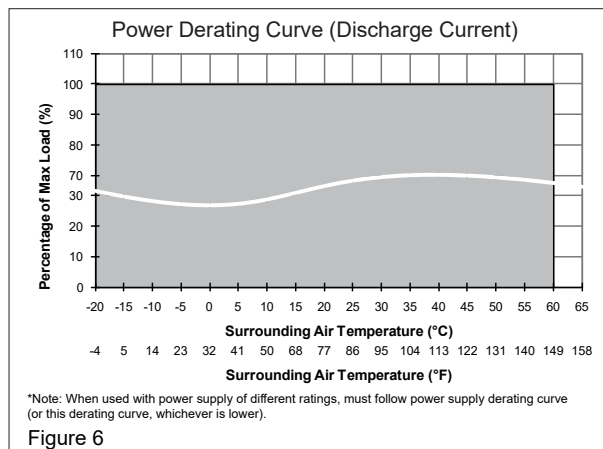

## Signal wiring diagram

Contact relay rating: 1A/30VDC.

No polarity requirement.

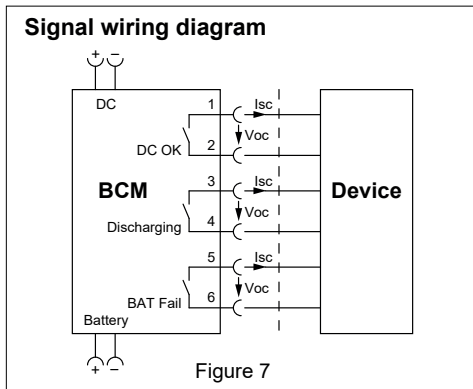

## Buffering Time

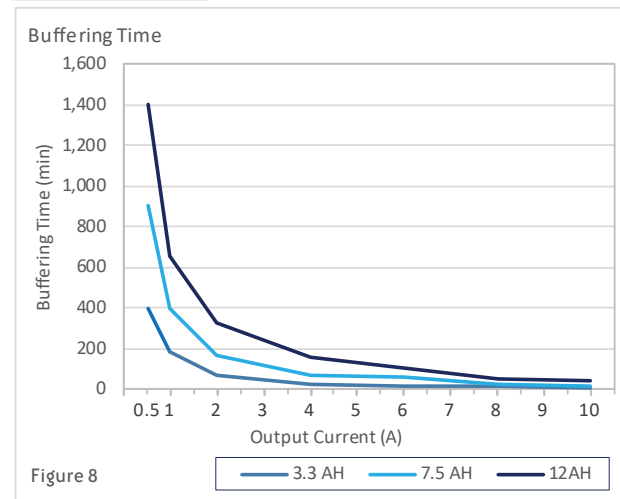

BCM Status	Status Indicators			LED Display Status
	Relay Output Connector			
	Discharging	BAT Fail	DC OK	
Battery Fully Charged	Open	Open	Closed	Green LED On
Battery Charging	Open	Open	Closed	Green LED Flashing
Battery Discharging* (Buffering Mode)	Closed*	Open	Closed	Orange LED Flashing
No Battery Connected	Open	Closed	Open	Red LED On
Output Shutdown	Open	Open	Open	No Light

\* With output current 0.1 A to 10A.

Output Current	Buffering Time (minutes)		
	3.3 AH	7.5 AH	12AH
0.5 A	400	900	1400
1A	180	398	654
2A	70	165	323
4A	28	72	160
6A	19	55	103
8A	11	22	49
10A	7	18	37

## Typical application notes

### Typical Application Notes

#### 9.1 Provide backup power during AC source interruption or failure

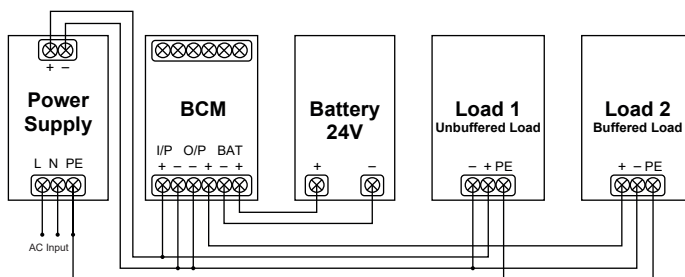

#### 9.2 Can be combined with redundancy module (PSB60-REM20S)

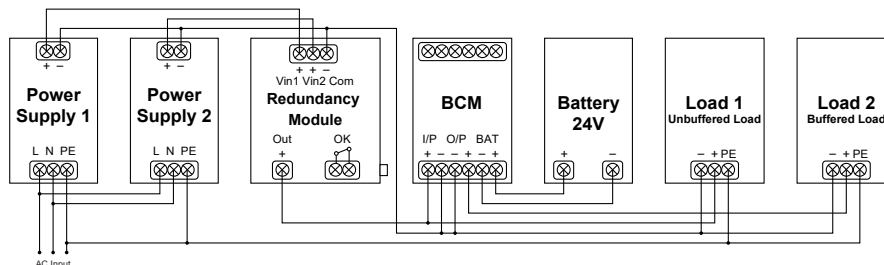





Figure 9

RHINO PSL-24-BCM240 Battery Control Module

Technical Specifications		
<b>Input (DC)</b>		
Nominal input voltage		24VDC
Voltage range		24-28 VDC
Maximum input voltage		< 33 VDC
Input current		Charging Mode: 0.5 ± 0.1 A (25°C) Discharging Mode: 10A Max.
Charging time		< 30 hr ± 5 hr (25°C) for battery 24V/12AH
Efficiency		Charging Mode: > 80.0% Discharging Mode: > 99.0%
<b>Output (DC)</b>		
Nominal output voltage		24VDC typ. (depends on Vin)
Discharging voltage		22-28 VDC
Maximum output voltage		< 33 VDC
Output current		10A Max.
Derating		Refer to Fig. 6
Component derating		Vin = 28.0 VDC, Max. load
Short circuit / Overload		Discharging Mode: Shutdown and no damage
<b>Recommended Batteries</b>		
Battery types		24 V, VRLA 2 x 12V, VRLA
Battery capacity		3.3-12.0 Ah
Battery voltage range		23-28VDC (continuous operating), 33VDC Max (maximum voltage that will not cause damage to the unit) 20VDC Min (voltage level of battery to enable "BAT Fail" function)
Battery fuse		Auto 15A / 58V, MINI (Littelfuse) or similar in the battery path (protects the wires between the battery and the battery control module)
<b>General Data</b>		
Type of housing		Plastic (PC), enclosed
LED signals		Green LED On = Unit is fully charged Green LED Flashing = Unit is charging Orange LED Flashing = Unit is discharging Red LED On = Battery fail (no battery is connected) Orange LED On = Battery 24 V or DC 24 V reverse polarity
Signal relay contacts		DC OK = Contact is closed when battery is fully charged and the unit is ready to discharge/buffer. DISCHARGING = Contact is closed when the unit is discharging/buffering with output current of 5mA-10 A. BATTERY FAIL = Contact is closed when the battery fails to function.
MTBF		> 500,000 hrs. as per Telcordia
Dimensions (L x W x H)		91mm x 71mm x 55.6 mm [3.58 in x 2.80 in x 2.19 in] (See for complete engineering drawings.)
Weight		0.14 kg [4.9 oz]
Connection method		Screw connection
Stripping length		7mm [0.28 in]
Operating temperature (surrounding air temperature)		-20°C to +60°C [-4°F to +140°F] (Refer to Fig. 7)
Storage temperature		-25°C to +85°C [-13°F to +185°F]
Humidity at +25°C, no condensation		5 to 95% RH
Vibration		Operating: IEC60068-2-6, Sine Wave: 10Hz to 500Hz @ 19.6 m/s <sup>2</sup> (2G peak); 10 min per cycle, 60 min for all X, Y, Z directions Non-Operating: IEC60068-2-6, Random: 5Hz to 500Hz (2.09Grms); 20 min per axis for all X, Y, Z directions
Shock (in all directions)		Operating: IEC60068-2-27, Half Sine Wave: 4G for a duration of 22ms, 3 shocks for each 3 directions Non-Operating: IEC60068-2-27, Half Sine Wave: 50G for a duration of 11ms, 3 shocks for each 3 directions
Pollution degree		2
Altitude (operating)		3000m
<b>Certification and Standards</b>		
Electrical equipment of machines		IEC60204-1
Electronic equipment for use in electrical power installations		EN62477-1 / IEC62103-1
Safety entry low voltage		PELV (EN60204), SELV (EN 60950)
Electrical safety (of information technology equipment)		UL/C-UL recognized to UL60950-1 and CSA C22.2 No. 60950-1 (File No. E198298), CB scheme to IEC60950-1
Industrial control equipment		UL/C-UL listed to UL508 and CSA C22.2 No.107.1-01 (File No. E197592)
CE		In conformance with EMC directive 2014/30/EU and Low Voltage Directive 2014/35/EU
Component power supply for general use		EN61204-3
Immunity		EN55024, EN61000-6-2 (EN61000-4-2, 3, 4, 5, 6, 8)
Emission		EN55032, EN55011
		  
RoHS Compliant		Yes
<b>Safety and Protection</b>		
Isolation voltage:	Input & Output / PE Signal / PE Input & Output / Signal	1kVAC 1kVAC 1kVAC
Polarity protection		Yes
Protection degree		IP20
Safety class		Class III

RHINO PSL-24-BCM240 Battery Control Module

## Dimensions

mm [inches]

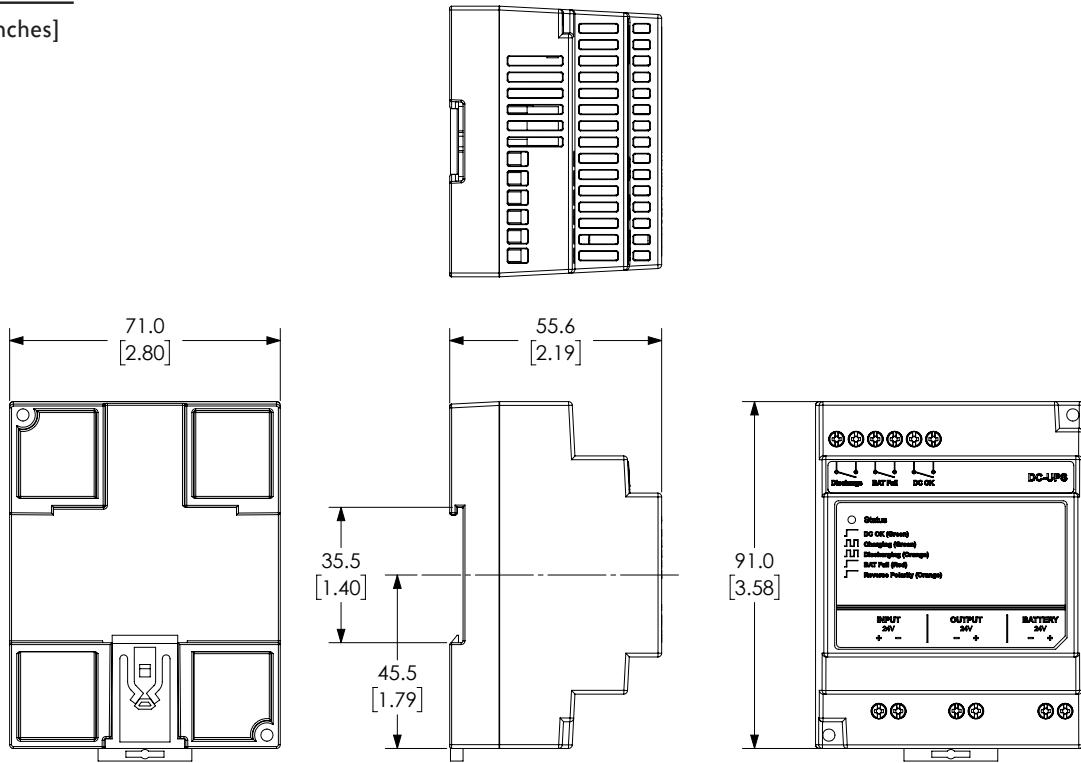

## Block Diagram

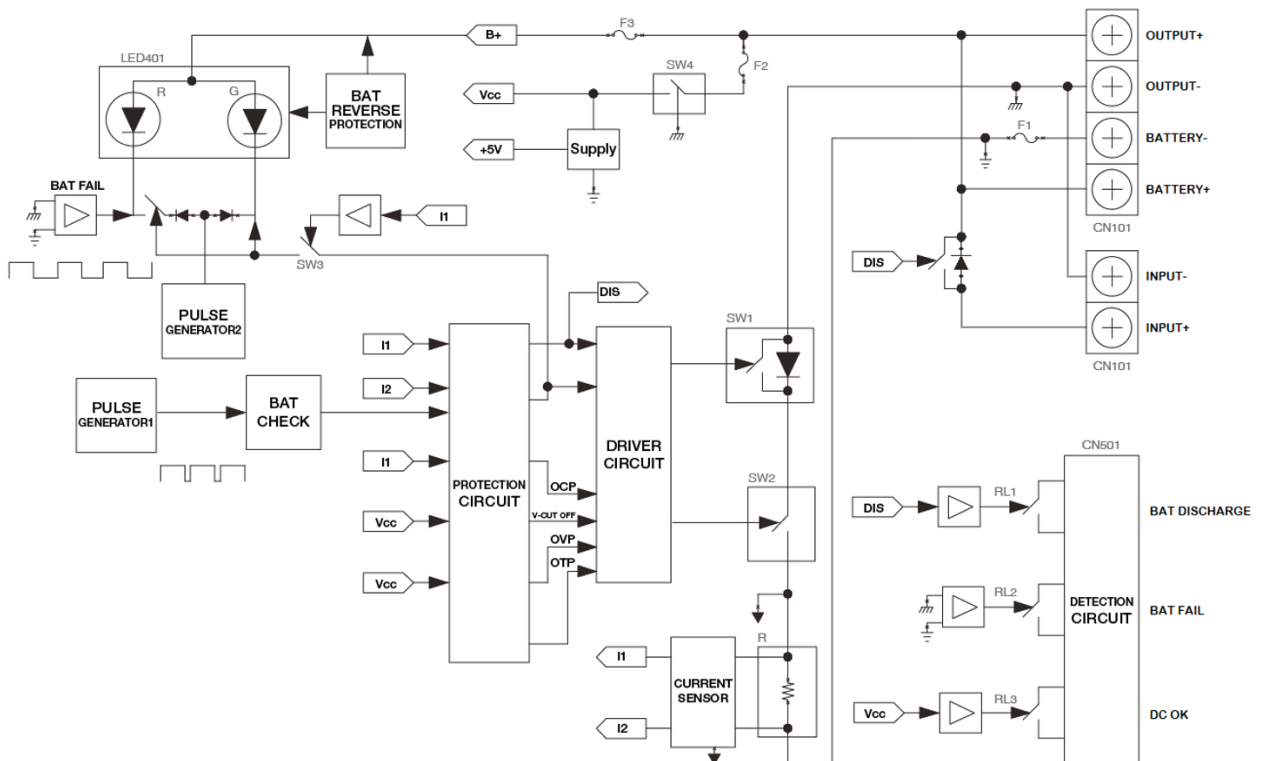

RHINO PSL-24-BCM240 Battery Control Module

## Troubleshooting

Troubleshooting		
<b>Problem</b>	<b>Possible Cause</b>	<b>Suggestion</b>
Orange LED is ON Steady	Input connection or battery connection is reverse polarity.	Check polarity of input connection and battery connection and make corrections.
BCM does not operate in charging mode after input is applied	Input wiring is open or no input voltage to the BCM is supplied.	Check wiring and voltage of input supply.
	Internal fuse is opened.	Replace the battery control module.
BCM does not operate in buffering mode after input voltage drops	Battery wiring is not connected or is opened.	Check battery wiring and compare with Typical Application Notes in this BCM datasheet. Make corrections as needed.
	Battery has not had enough time to be charged and it is still below the continuous operating voltage range.	Check battery voltage and compare with minimum required battery voltage provided in this BCM document.
	Protection mode enabled.	Check for overvoltage, overcurrent, over temperature, or short circuit condition, and correct.

# RHINO Battery Control Modules Overview

A battery control module (BCM), in combination with an external sealed lead acid battery, can be added to a DC power supply to create a DC uninterruptible power supply (UPS) that will maintain power to a connected load upon loss of mains power.

The battery control module performs several key functions in the DC UPS system. Under normal conditions, it monitors the status of the DC input power, monitors and controls charging of the external lead acid battery, and provides status/alarm contacts to allow remote monitoring of the state of the UPS.

In the event that the DC power supply voltage drops out, the BCM monitors and supplies power to the load from the battery and monitors the battery during discharge.

Several battery control modules, with a range of features, are available for use with RHINO power supplies. Key differentiating features of the battery control modules are delineated in the following table.

Battery Control Module Selection Guide				
Part Number	PSH-BCM360S	PSB24-BCM960S	PSL-24-BCM240	PSM24-BCM360S
Price				
Highlights	<b>Most versatile</b>	<b>Highest power Lowest cost/watt Conformal coating</b>	<b>Lowest cost</b>	<b>Legacy</b>
Nominal Output Voltage	24/48 VDC	24 VDC	24 VDC	24 VDC
Amperage Rating	15A at 24 VDC, 7.5 A at 48 VDC	40A	10A	15A
Number of Power Inputs	Redundant inputs for two independent power supplies	One power supply	One power supply	One power supply
Battery Type	12V sealed lead acid	24V sealed lead acid	24V sealed lead acid	24V sealed lead acid
Protection Type	Over voltage, Over current, Deep discharge, Reverse polarity, Battery overcharge, Over temperature			
Battery Temperature Compensation	<b>Yes</b>	No	No	<b>Yes</b>
Compatibility	Universal	Universal	Universal	Requires RHINO PSM24 power supply

