

proSense® RTD Probes with Attached Plug

RTD1-PXX-01



Overview

- All temperature sensors are pre-built stock items
- 100 ohm platinum RTD 3-wire element
- Class A accuracy
- 1/4" diameter, 316 stainless steel sheath to protect against harsh environments
- RTD element encased in alumina powder insulation provides excellent vibration dampening and heat transfer
- 6", 12", or 18" probe length
- Attached 3-pin plug for quick and easy wiring connections
- Made in the USA



RTD Probes with Attached Plug										
Part Number	Pcs/Pkg	Wt (lb)	Price	Type	Probe Diameter (O.D.)	Probe Length	Temperature Sensing Range	Mounting	Attached Plug Size	Mating Jack
RTD1-P06-01	1	0.3		PT 100, 3-wire	1/4"	6"	-50 to 300°C (-58 to 572°F) Plug rated to 400°F (204°C)	ProSense compression fitting (see accessories, purchased separately)	Standard size, 3-pin	RTD-SJ (see accessories, sold separately)
RTD1-P12-01			12"							
RTD1-P18-01			18"							

Technical Specifications	
Sensing Element	Single 100 ohm platinum (Pt 100). 3-wire; TCR = 0.00385 ohm/ohm/°C
Initial Accuracy	Class A $\pm[0.15 + 0.002 t]$ °C
Probe	$\varnothing 1/4"$, 316 stainless steel sheath, single RTD is embedded in alumina powder
Minimum Installation Depth	3" (76 mm)
Response Time	7 seconds, 63% of a 25 to 77°C step change (ASTM E1137)
Wiring	Attached 3-pin standard size plug (mating jack sold separately, see accessories)



NOTE: CHECK THE CHEMICAL COMPATIBILITY OF THE SENSOR'S WETTED PARTS WITH THE MEDIUM TO BE MEASURED.

Dimensions

inches [mm]

RTD1-PXX-01

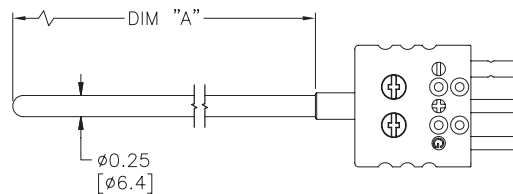

Wiring Information

PT100: white plug

Pins labeled +, -, and G

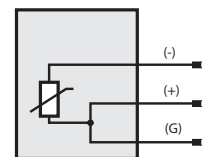

TABLE A	
PART NUMBER	DIM "A"
RTD1-P06-01	6.00[152.4]
RTD1-P12-01	12.00[304.8]
RTD1-P18-01	18.00[457.2]

pro^sense[®] RTD Probes with Attached Plug - Accessories

Accessories

Part No.	Description	Pcs/Pkg	Price
BCF14-125N	Compression fitting, brass, for 1/4 inch diameter temperature probes, 1/8 inch NPT male thread	1	
BCF14-25N	Compression fitting, brass, for 1/4 inch diameter temperature probes, 1/4 inch NPT male thread	1	
BCF14-50N	Compression fitting, brass, for 1/4 inch diameter temperature probes, 1/2 inch NPT male thread	1	
CF14-125N	Compression fitting, 316 stainless steel, for 1/4 inch diameter temperature probes, 1/8 inch NPT male thread	1	
CF14-25N	Compression fitting, 316 stainless steel, for 1/4 inch diameter temperature probes, 1/4 inch NPT male thread	1	
CF14-50N	Compression fitting, 316 stainless steel, for 1/4 inch diameter temperature probes, 1/2 inch NPT male thread	1	
CFTF-14	Teflon™ ferrule for brass or stainless steel compression fittings and 1/4 diameter temperature probes	5	
RTD-SJ	RTD 3-pin connector, standard round pin jack, maximum continuous temperature 400°F (200°C), white body, copper pins, 14 AWG maximum (2.0 mm) wire size	1	
WCB-S	Wire / cable clamp bracket for use with standard thermocouple and RTD connectors.	4	

*Note: RTD extension lead wire available at the end of this section.
See end of section for full listing of accessories and dimension information.*

**Working pressure of compression fitting should not exceed 500 psi. However we recommend any pressure application use a thermowell*

CF14-50N

CF14-25N

CF14-125N



S.S. Compression Fittings

BCF14-50N

BCF14-25N

BCF14-125N



Brass Compression Fittings

RTD-SJ

RTD-SP



RTD Connectors

pro^osense® Connection Head and Ceramic Terminal Bases



Overview

- Cast aluminum NEMA 4X, IP66 screw cover head with captive gasket
- One turn cover removal & installation eliminates cross threading and saves time
- 3/4" NPT conduit opening with internal stop to prevent overtightening and installation damage
- Gripping ribs on cover edge
- Stainless steel cover chain
- Made in the USA

ProSense Aluminum Connection Head				
Part Number	Description	Pcs/ Pkg	Wt(lb)	Price
CHSC-AL-1	ProSense general purpose screw cover connection head for temperature probes, die-cast aluminum, 1/2 NPT process opening, 3/4 NPT conduit opening, NEMA 4X, IP66 rated, graphite gasket, maximum temperature rating of 825°F (440°C)	1	1.0	

Dimensions

inches [mm]

CHSC-AL-1

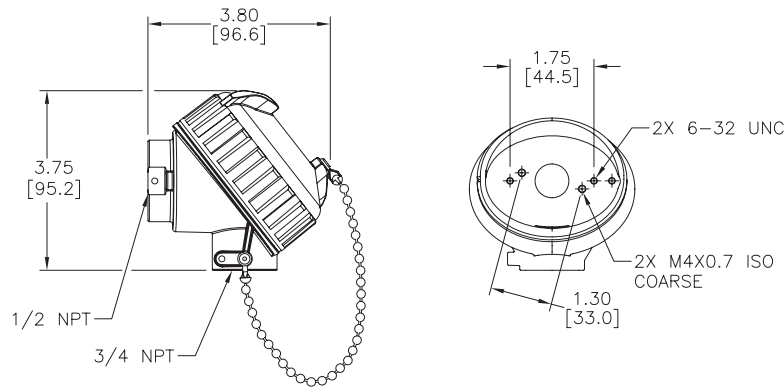

CHTB-2



CHTB-3

Overview

- Available with two terminals for thermocouples or three terminals for RTDs
- Fits CHSC-AL-1 connection heads
- Ceramic base with brass terminals and stainless steel screws
- Accepts up to 12 AWG wire

Terminal Base for Connection Heads				
Part Number	Description	Pcs/ Pkg	Wt(lb)	Price
CHTB-2	ProSense ceramic terminal base, two brass terminals with stainless steel screws, for use with ProSense temperature probe connection heads, two mounting screws included.	1	1.0	
CHTB-3	ProSense ceramic terminal base, three brass terminals with stainless steel screws, for use with ProSense temperature probe connection heads, two mounting screws included.	1	1.0	

Dimensions

inches [mm]

CHTB-2

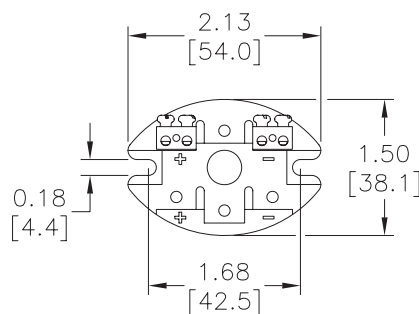

CHTB-3

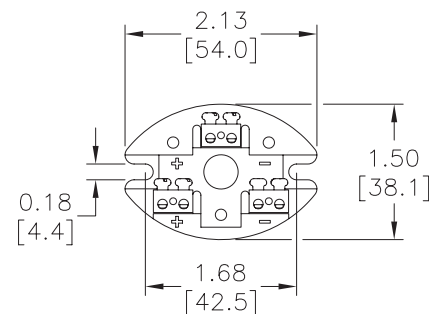

pro^oense[®] Compression Mounting Fittings for Temperature Probes

Compression Mounting Fittings for Temperature Probes				
Part Number	Description	Pcs/Pkg	Wt(lb)	Price
BCF18-125N	Compression fitting, brass, for 1/8 inch diameter temperature probes, 1/8 inch NPT male thread	1	0.5	
BCF14-125N	Compression fitting, brass, for 1/4 inch diameter temperature probes, 1/8 inch NPT male thread	1	0.5	
BCF18-25N	Compression fitting, brass, for 1/8 inch diameter temperature probes, 1/4 inch NPT male thread	1	0.5	
BCF14-25N	Compression fitting, brass, for 1/4 inch diameter temperature probes, 1/4 inch NPT male thread	1	0.5	
BCF18-50N	Compression fitting, brass, for 1/8 inch diameter temperature probes, 1/2 inch NPT male thread	1	0.5	
BCF14-50N	Compression fitting, brass, for 1/4 inch diameter temperature probes, 1/2 inch NPT male thread	1	0.5	
CF18-125N	Compression fitting, 316 stainless steel, for 1/8 inch diameter temperature probes, 1/8 inch NPT male thread	1	0.5	
CF14-125N	Compression fitting, 316 stainless steel, for 1/4 inch diameter temperature probes, 1/8 inch NPT male thread	1	0.5	
CF18-25N	Compression fitting, 316 stainless steel, for 1/8 inch diameter temperature probes, 1/4 inch NPT male thread	1	0.5	
CF14-25N	Compression fitting, 316 stainless steel, for 1/4 inch diameter temperature probes, 1/4 inch NPT male thread	1	0.5	
CF18-50N	Compression fitting, 316 stainless steel, for 1/8 inch diameter temperature probes, 1/2 inch NPT male thread	1	0.5	
CF14-50N	Compression fitting, 316 stainless steel, for 1/4 inch diameter temperature probes, 1/2 inch NPT male thread	1	0.5	
CFTF-18	Teflon™ ferrule for brass or stainless steel compression fittings and 1/8 diameter temperature probes	5	0.5	
CFTF-14	Teflon ferrule for brass or stainless steel compression fittings and 1/4 diameter temperature probes	5	0.5	
CF06-25N	1/4 NPT stainless steel compression fitting for 0.24 inch (6 mm) diameter RTD probe with M12 connector.	1	0.18	
CF10-50N	1/2 NPT stainless steel compression fitting for 10 mm (0.4 inch) diameter RTD probe with M12 connector.	1	0.20	
CF18-BC	Bayonet compression fitting, for 1/8" diameter probe sheath sensors	1	0.1	
BB125N-50N	Reducing bushing, brass, 1/2 MNPT x 1/8 FNPT, hex head	1	0.1	

NOTE: CHECK THE CHEMICAL COMPATIBILITY OF THE SENSOR'S WETTED PARTS WITH THE MEDIUM TO BE MEASURED.

**Working pressure of compression fitting should not exceed 500 psi. However we recommend any pressure application use a thermowell*

CF14-125N



CF14-50N



CF14-25N



CF18-BC



CF06-25N



CF10-50N



BCF18-125N



BCF18-25N



BCF18-50N



BB125N-50N



CFTF-14



CFTF-18



pro^{sense}® Compression Mounting Fittings for Temperature Probes

BCF14-125N



BCF14-25N



BCF14-50N



CF18-25N



CF18-50N



CF18-125N



Dimensions

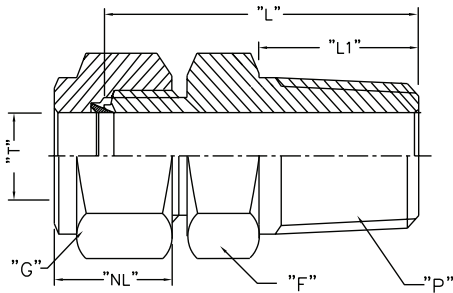

Note: All threaded connections should be hand tightened and then turned 1 to 2 full turns for proper sealing.

Actual torque required for a proper seal of NPT threads is influenced by tolerance, sealant, lubricant, etc.

ProSense Compression Fittings									
Part No.	Weight (lb)	Description	"T" Tube O.D.	"P" NPT(M)	"L" Body Length*	"L1" Thread Length**	"F" Body Hex**	"G" Nut Hex**	"NL" Nut Length**
BCF18-125N/ CF18-125N	0.5	1/8" OD x 1/8" NPT(M)	0.128/0.132	1/8" NPT(M)	0.909"	0.393"	0.5"	0.433"	0.492"
BCF14-125N/ CF14-125N	0.5	1/4" OD x 1/8" NPT(M)	0.253/0.257	1/8" NPT(M)	1.0"	0.393"	0.5"	0.559"	0.5"
BCF18-25N/ CF18-25N	0.5	1/8" OD x 1/4" NPT(M)	0.128/0.132	1/4" NPT(M)	1.114"	0.551"	0.551"	0.433"	0.492"
BCF14-25N/ CF14-25N	0.5	1/4" OD x 1/4" NPT(M)	0.253/0.257	1/4" NPT(M)	1.188"	0.551"	0.551"	0.559"	0.5"
BCF18-50N/ CF18-50N	0.5	1/8" OD x 1/2" NPT(M)	0.128/0.132	1/2" NPT(M)	1.377"	0.748"	0.866"	0.433"	0.492"
BCF14-50N/ CF14-50N	0.5	1/4" OD x 1/2" NPT(M)	0.253/0.257	1/2" NPT(M)	1.437"	0.748"	0.866"	0.559"	0.5"
CF06-25N	0.18	6 mm OD x 1/4" NPT(M)	0.236/0.240	1/4" NPT(M)	1.174"	0.59"	0.67"	0.55"	0.587"
CF10-50N	0.20	10 mm OD x 1/2" NPT(M)	0.394/0.399	1/2" NPT(M)	1.458"	0.55"	1.06"	0.75"	0.608"

Note: All dimensions are in inches

** ± 0.07*

*** ± 0.03*

Note: Once the compression fitting has been fully tightened on the probe, the ferrule will be locked onto the probe and cannot be removed or reused.

**Working pressure of compression fitting should not exceed 500 psi. However we recommend any pressure application use a thermowell*



Scan the QR Code or click to view the CF06 & CF10 Compression Fitting Installation Instructions

Bayonet Mounting Adapter for Temperature Sensors

Bayonet Mounting Adapter for Temperature Sensors					
Part Number	Description	Material	Pcs/Pkg	Wt(lb)	Price
BA-078	Bayonet adapter, 7/8 inch long, 7/16 inch outside diameter, 9/32 inch inside diameter, 1/8 inch MNPT	Stainless Steel (304)	1	0.5	
BA-100	Bayonet adapter, 1 inch long, 7/16 inch outside diameter, 9/32 inch inside diameter, 1/8 inch MNPT		1	0.5	
BA-114	Bayonet adapter, 1-1/4 inch long, 7/16 inch outside diameter, 9/32 inch inside diameter, 1/8 inch MNPT		1	0.5	
BA-112	Bayonet adapter, 1-1/2 inch long, 7/16 inch outside diameter, 9/32 inch inside diameter, 1/8 inch MNPT		1	0.5	
BA-200	Bayonet adapter, 2 inch long, 7/16 inch outside diameter, 9/32 inch inside diameter, 1/8 inch MNPT		1	0.5	
BA-212	Bayonet adapter, 2-1/2 inch long, 7/16 inch outside diameter, 9/32 inch inside diameter, 1/8 inch MNPT		1	0.5	
BA-300	Bayonet adapter, 3 inch long, 7/16 inch outside diameter, 9/32 inch inside diameter, 1/8 inch MNPT		1	0.5	
BA-312	Bayonet adapter, 3-1/2 inch long, 7/16 inch outside diameter, 9/32 inch inside diameter, 1/8 inch MNPT		1	0.5	
CF18-BC	Adjustable bayonet compression fitting, for 1/8" diameter probe sheath sensors		1	0.1	
BB125N-50N	Reducing bushing, 1/2 MNPT x 1/8 FNPT, hex head	Brass	1	0.1	



NOTE: CHECK THE CHEMICAL COMPATIBILITY OF THE SENSOR'S WETTED PARTS WITH THE MEDIUM TO BE MEASURED.

BA-078



BA-100



BA-114



CF18-BC



BA-300



BA-112



BB125N-50N



BA-312



BA-200



BA-212



proSense® Pipe Clamp Adapters



PCA-300

Overview

- For use with ProSense adjustable immersion thermocouple and RTD sensors
- Available in adjustable diameters from 11/16 to 7 inches
- Provides an easy means of sensing temperature on the outside of a pipe



Shown with optional adjustable immersion sensor

Pipe Clamp Adapters for ProSense Adjustable Immersion Sensors				
Part Number	Description	Pcs/ Pkg	Wt(lb)	Price
PCA-125	ProSense pipe clamp adapter, 11/16 to 1-1/4 inch adjustable diameter, 2-inch attached bayonet adapter with 7/16 inch outside diameter and 9/32 inch inside diameter. Use with ProSense adjustable immersion sensors.	1	0.1	
PCA-200	ProSense pipe clamp adapter with 1-1/16 to 2 inch adjustable diameter, 2-inch attached bayonet adapter with 7/16 inch outside diameter and 9/32 inch inside diameter. Use with ProSense adjustable immersion sensors.	1	0.1	
PCA-300	ProSense pipe clamp adapter with 2-1/16 to 3 inch adjustable diameter, 2-inch attached bayonet adapter with 7/16 inch outside diameter and 9/32 inch inside diameter. Use with ProSense adjustable immersion sensors.	1	0.1	
PCA-425	ProSense pipe clamp adapter with 3-5/16 to 4-1/4 inch adjustable diameter, 2-inch attached bayonet adapter with 7/16 inch outside diameter and 9/32 inch inside diameter. Use with ProSense adjustable immersion sensors.	1	0.1	
PCA-500	ProSense pipe clamp adapter with 4-1/8 to 7 inch adjustable diameter, 2-inch attached bayonet adapter with 7/16 inch outside diameter and 9/32 inch inside diameter. Use with ProSense adjustable immersion sensors.	1	0.1	

Dimensions

inches [mm]

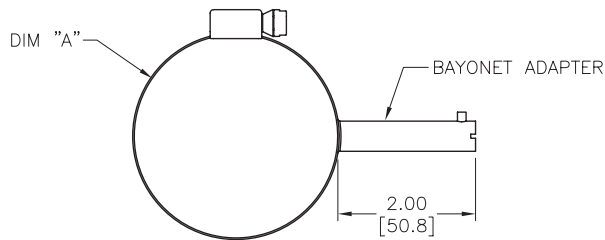

PART NUMBER	DIM "A"	FITS PIPE SIZES
PCA-125	ø0.68–1.25 [ø17.2–31.7]	1/2 TO 3/4 NPS
PCA-200	ø1.06–2.00 [ø26.9–50.8]	1 TO 1-1/2 NPS
PCA-300	ø2.06–3.00 [ø52.3–76.2]	2 TO 2-1/2 NPS
PCA-425	ø3.31–4.25 [ø84.1–108.0]	3 TO 3-1/2 NPS
PCA-500	ø4.12–7.00 [ø104.6–177.8]	4 TO 6 NPS

pro^{sense} Thermocouple and RTD Connectors

Overview

- Glass-filled high quality thermoplastic body with original thermocouple material pins and spring-loaded inserts
- Polarized pins
- Molded barriers prevent short circuit
- Captive central cover screw for easy assembly
- Easy wire connection pressure plate construction
- Stainless steel screws with combination head (Slotted and Phillips)
- 3-pin standard connectors have a third pin for ground or continuous shield, or for 3-wire RTDs



Thermocouple and RTD Connectors									
Part Number	Pcs/ Pkg	Wt(lb)	Price	Sensor Type	Connector Type	Temperature Rating	Body Color	Wire Size	Wire Cable Clamp Bracket
THMJ-SP	1	0.5		J	Standard round pin plug	Max continuous 400°F (200°C)	Black	32 AWG (0.2 mm) to 14 AWG maximum (2.0 mm)	WCB-S
THMJ-SJ	1	0.5	Standard round pin jack		–				
THMJ-SPJ	1	0.5	Standard round direct mount jack		–				
THMJ-MP	1	0.5	Miniature flat pin plug		40 AWG (0.08 mm) to 20 AWG maximum (0.8 mm)			WCB-M	
THMJ-MJ	1	0.5	Miniature flat pin jack					–	
THMJ-MPJ	1	0.5	Miniature round direct mount jack					–	
THMK-SP	1	0.5		K	Standard round pin plug	Max continuous 662°F (350°C)	Yellow	32 AWG (0.2 mm) to 14 AWG maximum (2.0 mm)	WCB-S
THMK-SJ	1	0.5	Standard round pin jack		–				
THMK-SPJ	1	0.5	Standard round direct mount jack		–				
THMK-MP	1	0.5	Miniature flat pin plug		40 AWG (0.08 mm) to 20 AWG maximum (0.8 mm)			WCB-M	
THMK-MJ	1	0.5	Miniature flat pin jack					–	
THMK-MPJ	1	0.5	Miniature round direct mount jack					–	
THMK-HSP	1	0.5		RTD	Standard hi-temp round pin plug	Max continuous 662°F (350°C)	Brown	32 AWG (0.2 mm) to 14 AWG maximum (2.0 mm)	WCB-S
THMK-HSJ	1	0.5	Standard hi-temp round pin jack		–				
THMT-SP	1	0.5		T	Standard round pin plug	Max continuous 400°F (200°C)	Blue	32 AWG (0.2 mm) to 14 AWG maximum (2.0 mm)	WCB-S
THMT-SJ	1	0.5	Standard round pin jack		–				
THMT-SPJ	1	0.5	Standard round direct mount jack		–				
THMT-MP	1	0.5	Miniature flat pin plug		40 AWG (0.08 mm) to 20 AWG maximum (0.8 mm)			WCB-M	
THMT-MJ	1	0.5	Miniature flat pin jack					–	
THMT-MPJ	1	0.5	Miniature round direct mount jack					–	
RTD-SP	1	0.5		RTD	Standard round pin plug	Max continuous 400°F (200°C)	White	32 AWG (0.2 mm) to 14 AWG maximum (2.0 mm)	WCB-S
RTD-SJ	1	0.5	Standard round pin jack		–				

THMT-SP



THMT-SJ



THMK-SP



THMK-SJ



THMJ-MP



THMJ-MJ



THMT-SPJ



THMT-MPJ



RTD-SP



RTD-SJ



THMK-HSP



THMK-HSJ



pro^{sense} Thermocouple and RTD Connectors

Dimensions

inches [mm]

THMJ, K, T, & H-SP

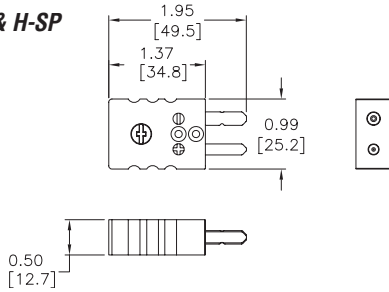

THMJ, K, T, & H-SJ

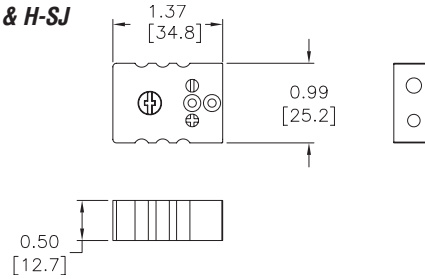

THMJ, K, & T-MP

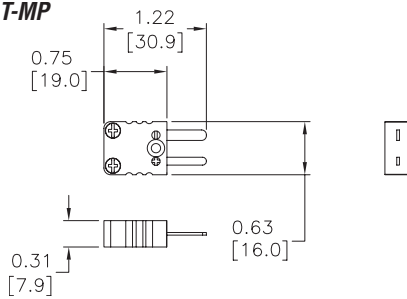

THMJ, K, & T-MJ

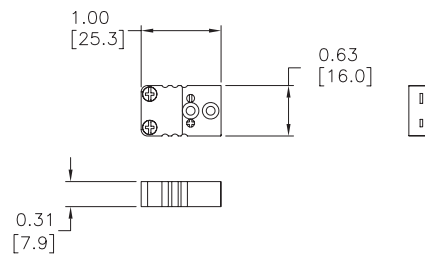

THMJ, K, & T-SPJ

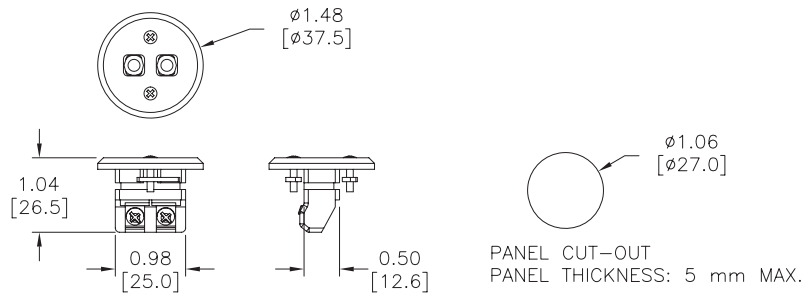

THMJ, K, & T-MPJ

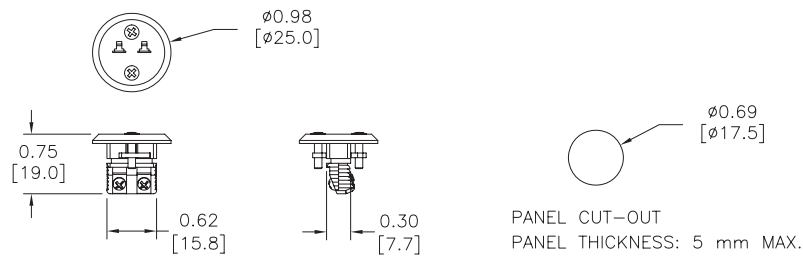

RTD-SP

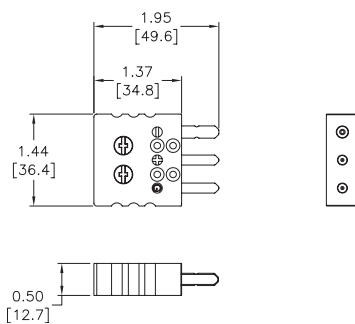

RTD-SJ

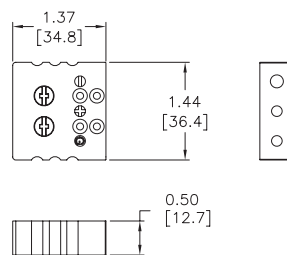

pro^{sense} Thermocouple and RTD Connectors

WCB-S



WCB-M



WCB-S Application



WCB-M Application



Thermocouple and RTD Connectors Accessories				
Part Number	Pcs/ Pkg	Wt(lb)	Price	Description
WCB-S	4	0.5		Wire / cable clamp bracket for use with standard thermocouple and RTD connectors.
WCB-M	4	0.5		Wire / cable clamp bracket for use with miniature thermocouple connectors.

Dimensions

inches [mm]

WCB-S

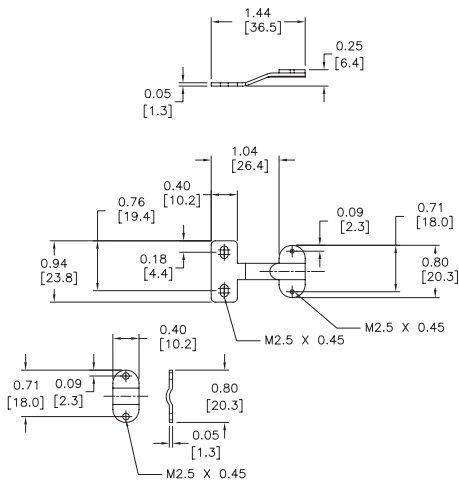

WCB-M

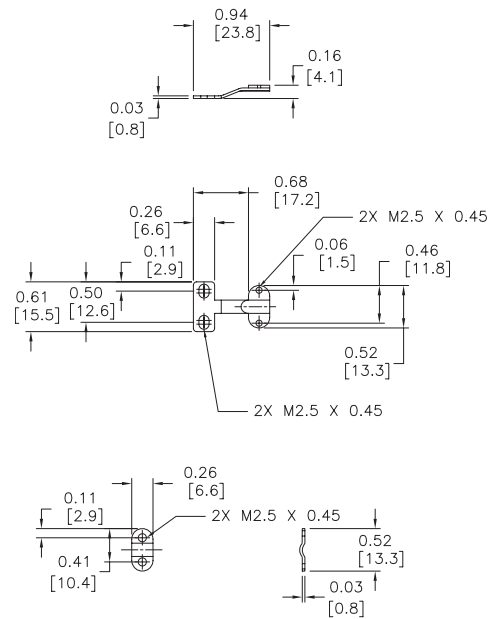

pro^{ense}® Thermocouple and RTD Temperature Range

Thermocouple Temperature Range		
THMK-C06-04	32 to 2100°F (0 to 1149°C)	
THMK-C12-04		
THMK-C18-04		
THMK-H06L01-03		
THMK-H12L01-03		
THMK-H18L01-03	32 to 2100°F (0 to 1149°C) lead wire transition rated to 204°C (400°F)	
THMK-T06L06-03		
THMK-T12L06-03		
THMK-T18L06-03		
TTD25C-20-0300F-H		
TTD25N-20-0300F-H	0 to 300°F (-17.8 to 148.9°C)	
THMJ-A01L04-01	32 to 900°F (0 to 482°C)	
THMJ-A01L06-01		
THMJ-A01L10-01		
THMJ-A01L10-02		
THMJ-B01L06-01		
THMJ-B01L06-02		
THMJ-B02L06-01		
THMJ-B02L06-02		
THMJ-D08L04-01		
THMJ-D08L06-01		
THMJ-D08L10-01		
THMJ-D08L10-02		
THMK-A01L04-01		
THMK-A01L06-01		
THMK-A01L10-01		
THMK-A01L10-02		
THMK-B01L06-01		
THMK-B01L06-02		
THMK-D08L04-01		
THMK-D08L06-01		
THMK-D08L10-01		
THMK-D08L10-02		
THMJ-T06L06-01		32 to 970°F (0 to 521°C), lead wire transition rated to 400 °F (204 °C)
THMJ-T12L06-01		
THMJ-T18L06-01		
THMJ-P06-01	32 to 970°F (0 to 521°C), plug rated to 400 °F (204 °C)	
THMJ-P12-01		
THMJ-P18-01		
THMJ-C04-03	32 to 1330°F (0 to 720°C)	
THMJ-C04R-03		
THMJ-C06-01		
THMJ-C06-02		
THMJ-C06-03		
THMJ-C06R-03		
THMJ-C12-01		
THMJ-C12-02		
THMJ-C12-03		
THMJ-C12R-03		
THMJ-C18-01		
THMJ-C18-02		
THMJ-H04L01-02		
THMJ-H06L01-01		
THMJ-H06L01-02		
THMJ-H12L01-01		
THMJ-H12L01-02		
THMJ-H18L01-01		

Thermocouple Temperature Range		
THMJ-T06L06-02	32 to 1330°F (0 to 720°C) lead wire transition rated to 400 °F (204 °C)	
THMJ-T12L06-02		
THMJ-T18L06-02		
THMJ-P06-02	32 to 1330°F (0 to 720°C) plug rated to 400 °F (204 °C)	
THMJ-P12-02		
THMJ-P18-02		
THMK-C04-03	32 to 1700°F (0 to 927°C)	
THMK-C04R-03		
THMK-C06-01		
THMK-C06-02		
THMK-C06R-03		
THMK-C12-01		
THMK-C12-02		
THMK-C12-03		
THMK-C12R-03		
THMK-C18-01		
THMK-C18-02		
THMK-H04L01-02		
THMK-H06L01-01		
THMK-H06L01-02		
THMK-H12L01-01		
THMK-H12L01-02		
THMK-H18L01-01		
THMK-T06L06-01		32 to 1700°F (0 to 927°C) lead wire transition rated to 400 °F (204 °C)
THMK-T06L06-02		
THMK-T12L06-01		
THMK-T12L06-02		32 to 1700°F (0 to 927°C) plug rated to 400 °F (204 °C)
THMK-T18L06-01		
THMK-T18L06-02		
THMK-P06-01		32 to 1700°F (0 to 927°C) plug rated to 400 °F (204 °C)
THMK-P06-02		
THMK-P12-01		
THMK-P12-02	32 to 900°F (0 to 482°C)	
THMK-P18-01		
THMK-P18-02		
THMK-B02L06-01	-328 to 700°F (-200 to 371°C), plug rated to 400 °F (204 °C)	
THMK-B02L06-02		
THMT-P06-01		
THMT-P12-01	-328 to 700°F (-200 to 371°C), lead wire transition rated to 400 °F (204 °C)	
THMT-P18-01		
THMT-T06L06-01		
THMT-T12L06-01	32 to 212°F (0 to 100°C)	
THMT-T18L06-01		
TTD25C-20-0100C-H		
TTD25N-20-0100C-H	-4 to 284°F (-20 to 140°C)	
TSD25N-0P-0284-H		

RTD Temperature Range	
RTD1-R01-01	40 to 185°F (-40 to 85°C)
RTD1-S04-01	-58 to 572°F (-50 to 300°C)
RTD1-S04-02	
RTD1-S04-03	
RTD1-S04-04	
RTD1-B01L06-01	
RTD1-B02L06-01	
RTD1-C04-03	
RTD1-C04R-03	
RTD1-C06-01	
RTD1-C06-03	
RTD1-C06R-03	
RTD1-C12-01	
RTD1-C12-02	
RTD1-C12-03	
RTD1-C12R-03	
RTD1-C18-01	-58 to 572°F (-50 to 300°C) Plug rated to 400°F (204°C)
RTD1-C18-02	
RTD1-H04L01-02	
RTD1-H06L01-01	-58 to 572°F (-50 to 300°C), lead wire transition rated to 400°F (204°C)
RTD1-H06L01-02	
RTD1-H12L01-01	
RTD1-H12L01-02	
RTD1-H18L01-01	
RTD1-P06-01	
RTD1-P12-01	
RTD1-P18-01	
RTD1-D08L10-01	
RTD1-T06L06-01	
RTD1-T12L06-01	
RTD1-T18L06-01	

J, K, & T Thermocouple Color Code

	White	+
J	Red	-
	Yellow	+
K	Red	-
	Blue	+
T	Blue	+
	Red	-