



Thermowells for Spring-Loaded Thermocouples and RTD's or Thermometers

TW06-01



TW06-02



Overview

- All thermowells are pre-built stock items
- Thermowells designed for use with ProSense spring-loaded thermocouple and RTD probes or ProSense Thermometers eliminate the need for a separate probe mounting fitting or adapter
- Drilled bar stock one piece construction (no welds) from 304 or 316 stainless steel
- 1/2" and 3/4" NPT male process threads available
- Designs and fabrication comply with ASME B31.1 and boiler and pressure vessel codes
- Material complies with NACE MR 0175 / ISO 15156
- CRN registered for all Canadian provinces
- Made in the USA



Thermowells for Spring-Loaded Thermocouples and RTD's or Thermometers										
Part Number	Pcs/Pkg	Wt(lb)	Price	I.D.	Overall Length/"U" Length	Male Process Threads	Female Probe Threads	Wetted Material	Temperature/Pressure Rating	Use With Probe or Thermometer
TW025-01	1	0.4		0.26"	2-3/4" / 1"	1/2" NPT	1/2" NPT	304 SS	304SS: 1000°F max; 3400psi max 316SS: 1000°F max; 5200psi max	T30-XXXX-25C T50-XXXX-25A
TW025-03	1	0.4				1/2" NPT		316 SS		
TW04-01	1	0.5			4-1/4" / 2-1/2"	1/2" NPT		304 SS		THMJ-C04-03 THMK-C04-03 THMJ-H04L01-02 THMK-H04L01-02 RTD1-C04-03 RTD1-H04L01-02 RTD1-50N-100-H T30-XXXX-4C T50-XXXX-4A XTP50N-100-XXXX ETS50N-100-XXXX
TW04-02	1	0.5				3/4" NPT		304 SS		
TW04-03	1	0.5				1/2" NPT		316 SS		
TW04-04	1	0.5				3/4" NPT		316 SS		
TW06-01	1	0.7			6-1/4" / 4-1/2"	1/2" NPT		304 SS		THMJ-C06-03 THMK-C06-03 THMJ-H06L01-02 THMK-H06L01-02 RTD1-C06-03 RTD1-H06L01-02 RTD1-50N-150-H T30-XXXX-6C T50-XXXX-6A XTP50N-150-XXXX ETS50N-150-XXXX
TW06-02	1	0.7				3/4" NPT		304 SS		
TW06-03	1	0.7				1/2" NPT		316 SS		
TW06-04	1	0.7				3/4" NPT		316 SS		
TW09-01	1	1.0			9-1/4" / 7-1/2"	1/2" NPT		304 SS		T50-XXXX-9A
TW09-03	1	1.0				1/2" NPT		316 SS		
TW12-01	1	1.2			12-1/4" / 10-1/2"	1/2" NPT		304 SS		THMJ-C12-03 THMK-C12-03 THMJ-H12L01-02 THMK-H12L01-02 RTD1-C12-03 RTD1-H12L01-02
TW12-02	1	1.2				3/4" NPT		304 SS		
TW12-03	1	1.2				1/2" NPT		316 SS		
TW12-04	1	1.2				3/4" NPT		316 SS		



NOTE: CHECK THE CHEMICAL COMPATIBILITY OF THE SENSOR'S (OR THERMOWELL'S) WETTED PARTS WITH THE MEDIUM TO BE MEASURED.



NOTE: RESPONSE TIME IS REDUCED WHEN INSTALLED IN A THERMOWELL. BE SURE TO INSTALL THE PROBE SO THAT IT CONTACTS THE END OF THE THERMOWELL FOR FASTER RESPONSE. THERMAL COMPOUND MAY BE USED DEPENDING ON APPLICATION.

pro^{ense} Thermowells for Spring-Loaded Thermocouples and RTD's or Thermometers

Spring-loaded Thermocouple or RTD and Thermowell Assembly Example



- Using spring-loaded probe design ensures positive tip contact with the bottom of the thermowell.
- Probes with hex nipple thread directly into thermowell. No additional probe mounting fittings are required.

Dimensions

inches [mm]

TW04-XX & TW025-XX

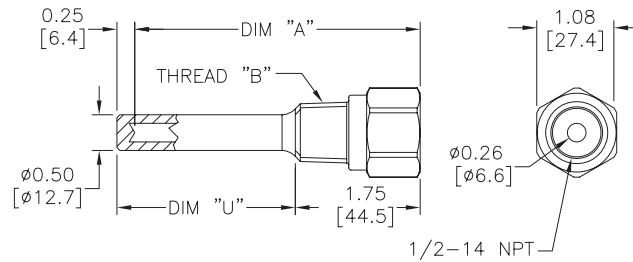

TABLE A

PART NUMBER	DIM "A"	THREAD "B" NPT	DIM "U"
TW025-01	2.50[63.5]	1/2-14	1.00[25.5]
TW025-03	2.50[63.5]	1/2-14	
TW04-01	4.00[101.6]	1/2-14	2.50[63.5]
TW04-02	4.00[101.6]	3/4-14	
TW04-03	4.00[101.6]	1/2-14	
TW04-04	4.00[101.6]	3/4-14	

Dimensions

inches [mm]

TW06-XX
TW09-XX
TW12-XX

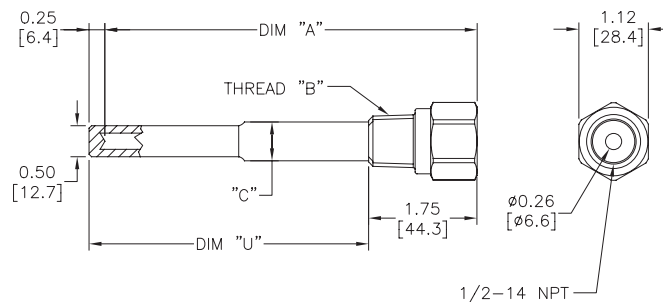
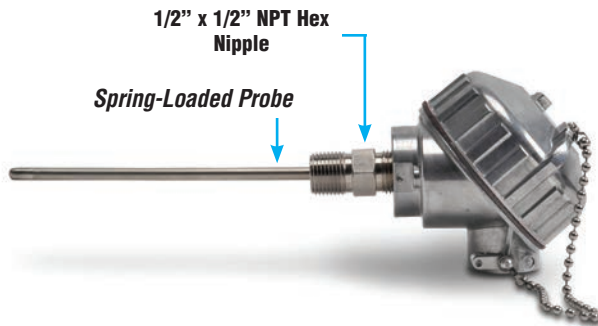

TABLE A

PART NUMBER	DIM "A"	THREAD "B" NPT	DIM "C"	DIM "U"
TW06-01	6.00[152.4]	1/2-14	0.63[15.9]	4.50[114.3]
TW06-02	6.00[152.4]	3/4-14	0.75[19.1]	
TW06-03	6.00[152.4]	1/2-14	0.63[15.9]	7.50[190.5]
TW06-04	6.00[152.4]	3/4-14	0.75[19.1]	
TW09-01	9.00[228.6]	1/2-14	0.63[15.9]	10.50[266.7]
TW09-03	9.00[228.6]	1/2-14	0.63[15.9]	
TW12-01	12.00[304.8]	1/2-14	0.63[15.9]	10.50[266.7]
TW12-02	12.00[304.8]	3/4-14	0.75[19.1]	
TW12-03	12.00[304.8]	1/2-14	0.63[15.9]	
TW12-04	12.00[304.8]	3/4-14	0.75[19.1]	

pro^{sense} Thermocouple Spring-Loaded Probes with Connection Head

THMJ & K - CXX-03



THMJ & K - CXXR-03
Replacement Probe



Open head



Overview

- All temperature sensors are pre-built stock items
- Probe
 - Spring-loaded for positive tip contact in thermowells
 - Type J or K thermocouple elements to meet many temperature sensing applications
 - 1/4" diameter, 316 SS sheath to protect against harsh environments
 - Magnesium Oxide (MgO) insulation provides vibration dampening and protection against thermal shock
 - 4", 6" or 12" probe length
- Connection Head
 - Cast aluminum NEMA 4X, IP66 screw cover head with captive gasket
 - One turn cover removal & installation eliminates cross threading and saves time
 - 3/4" NPT conduit opening with internal stop to prevent overtightening and installation damage
 - Gripping ribs on cover edge
 - Stainless steel cover chain
- Wiring
 - Ceramic terminal base
 - Brass terminals with stainless steel screws eliminate the need to wrap connections around screws
 - Elevated terminal block for easy wire termination
- Made in the USA



Thermocouple Spring-Loaded Probes with Connection Head - Types J and K								
Part Number	Pcs/Pkg	Wt (lb)	Price	Type	Probe Diameter (O.D.)	Probe Length	Temperature Sensing Range	Mounting
THMJ-C04-03	1	1.3		J	1/4"	4"	0 to 720°C (32 to 1330°F)	Integral 1/2" x 1/2" NPT Hex Nipple, 316 SS, Mount in thermowell (see accessories, purchased separately)
THMJ-C06-03				J		6"		
THMJ-C12-03				J		12"		
THMK-C04-03				K		4"	0 to 927°C (32 to 1700°F)	
THMK-C06-03				K		6"		
THMK-C12-03				K		12"		

Thermocouple Spring-Loaded Replacement Probes - Types J and K								
Part Number	Pcs/Pkg	Wt (lb)	Price	Type	Probe Diameter (O.D.)	Fits Probe Length	Temperature Sensing Range	For Use With
THMJ-C04R-03	1	0.2		J	1/4"	4"	0 to 720°C (32 to 1330°F)	THMJ-C04-03
THMJ-C06R-03				J		6"		THMJ-C06-03
THMJ-C12R-03				J		12"		THMJ-C12-03
THMK-C04R-03				K		4"	0 to 927°C (32 to 1700°F)	THMK-C04-03
THMK-C06R-03				K		6"		THMK-C06-03
THMK-C12R-03				K		12"		THMK-C12-03

pro^{sense}® Thermocouple Spring-Loaded Probes with Connection Head

Technical Specifications	
Junction Type	Ungrounded
ASTM E230 Standard Limits of Error	±2.2°C (±4.0°F) or 0.75%, whichever is greater
Probe	ø1/4", 316 stainless steel sheath, single thermocouple element is embedded in MgO powder
Connection Head	Die-cast aluminum, screw cover with stainless steel chain, compressed graphite gasket, NEMA 4X, IP66, 3/4" NPT conduit opening, max temp. 400°F (204°C)
Response Time	2.9 seconds, 63.2% of a 25-77°C step change per method ASTM E839
Wiring	Connection head: Ceramic terminal base with brass terminals and stainless steel screws (Recommended tightening torque 3-4 lb-in) Replacement Probes: 3 inch stranded 24 AWG wire leads



NOTE: CHECK THE CHEMICAL COMPATIBILITY OF THE SENSOR'S WETTED PARTS WITH THE MEDIUM TO BE MEASURED.

Dimensions

inches [mm]

THMJ & K - CXX-03

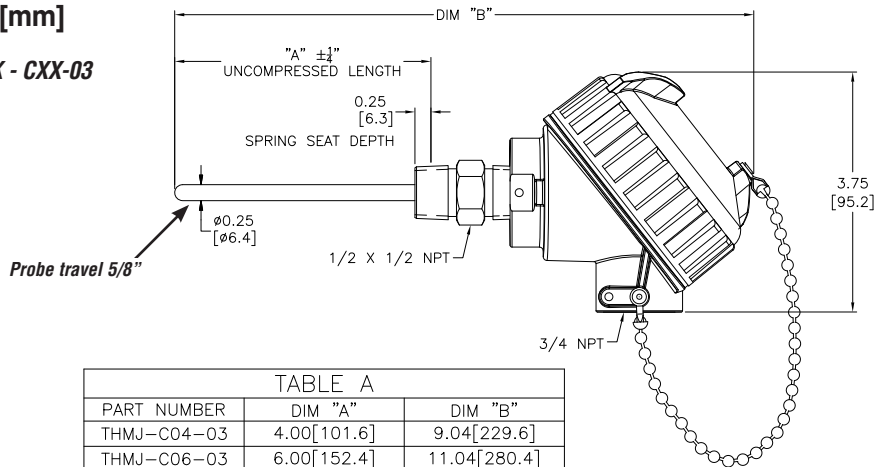

PART NUMBER	DIM "A"	DIM "B"
THMJ-C04-03	4.00[101.6]	9.04[229.6]
THMJ-C06-03	6.00[152.4]	11.04[280.4]
THMJ-C12-03	12.00[304.8]	17.04[432.8]
THMK-C04-03	4.00[101.6]	9.04[229.6]
THMK-C06-03	6.00[152.4]	11.04[280.4]
THMK-C12-03	12.00[304.8]	17.04[432.8]

Wiring Information

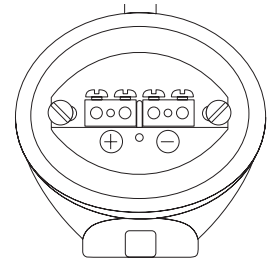

Type J: (+) white (-) red
Type K: (+) yellow (-) red

- Must use thermocouple extension lead wire, see end of this section
- Observe polarity when making connections
- Do not use standard wire nuts
- Recommended screw terminal tightening torque 3-4 lb-in

THMJ & K - CXXR-03
(Replacement Probes)

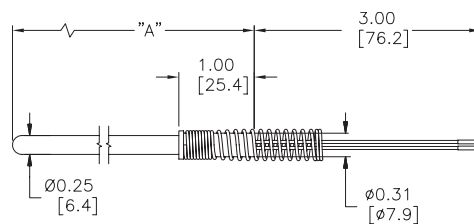

PART NUMBER	DIM "A"
THMJ-C04R-03	5.00[127.0]
THMJ-C06R-03	7.00[177.8]
THMJ-C12R-03	13.00[330.2]
THMK-C04R-03	5.00[127.0]
THMK-C06R-03	7.00[177.8]
THMK-C12R-03	13.00[330.2]

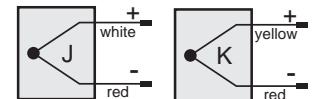

Probe Replacement

1. Open top cover.
2. Disconnect wires and remove terminal block.
3. Remove snap ring at bottom of head (snap ring pliers recommended).
4. Slide out old probe and slide new probe in place.
5. While compressing spring, replace snap ring.
6. Replace terminal block and connect probe wires.

pro^{sense}® Thermocouple Spring-Loaded Probes with Connection Head - Accessories

Accessories

Part No.	Description	Pcs/Pkg	Price
TW04-01	Standard duty threaded thermowell with 1/2 inch NPT male process threads, 304 stainless steel, 4-1/4 inch overall length with 0.260 inch bore diameter, for use with 4-inch long, 1/4 inch diameter spring loaded probes with 1/2 inch NPT threaded fitting, 2-1/2 inch insertion length	1	
TW04-02	Standard duty threaded thermowell with 3/4 inch NPT male process threads, 304 stainless steel, 4-1/4 inch overall length with 0.260 inch bore diameter for use with 4-inch long, 1/4 inch diameter spring loaded probes with 1/2 inch NPT threaded fitting, 2-1/2 inch insertion length	1	
TW04-03	Standard duty threaded thermowell with 1/2 inch NPT male process threads, 316 stainless steel, 4-1/4 inch overall length with 0.260 inch bore diameter for use with 4-inch long, 1/4 inch diameter spring loaded probes with 1/2 inch NPT threaded fitting, 2-1/2 inch insertion length	1	
TW04-04	Standard duty threaded thermowell with 3/4 inch NPT male process threads, 316 stainless steel, 4-1/4 inch overall length with 0.260 inch bore diameter for use with 4-inch long, 1/4 inch diameter spring loaded probes with 1/2 inch NPT threaded fitting, 2-1/2 inch insertion length	1	
TW06-01	Standard duty threaded thermowell with 1/2 inch NPT male process threads, 304 stainless steel, 6-1/4 inch overall length with 0.260 inch bore diameter for use with 6-inch long, 1/4 inch diameter spring loaded probes with 1/2 inch NPT threaded fitting, 4-1/2 inch insertion length	1	
TW06-02	Standard duty threaded thermowell with 3/4 inch NPT male process threads, 304 stainless steel, 6-1/4 inch overall length with 0.260 inch bore diameter for use with 6-inch long, 1/4 inch diameter spring loaded probes with 1/2 inch NPT threaded fitting, 4-1/2 inch insertion length	1	
TW06-03	Standard duty threaded thermowell with 1/2 inch NPT male process threads, 316 stainless steel, 6-1/4 inch overall length with 0.260 inch bore diameter for use with 6-inch long, 1/4 inch diameter spring loaded probes with 1/2 inch NPT threaded fitting, 4-1/2 inch insertion length	1	
TW06-04	Standard duty threaded thermowell with 3/4 inch NPT male process threads, 316 stainless steel, 6-1/4 inch overall length with 0.260 inch bore diameter for use with 6-inch long, 1/4 inch diameter spring loaded probes with 1/2 inch NPT threaded fitting, 4-1/2 inch insertion length	1	
TW12-01	Standard duty threaded thermowell with 1/2 inch NPT male process threads, 304 stainless steel, 12-1/4 inch overall length with 0.260 inch bore diameter for use with 12-inch long, 1/4 inch diameter spring loaded probes with 1/2 inch NPT threaded fitting, 10-1/2 inch insertion length	1	
TW12-02	Standard duty threaded thermowell with 3/4 inch NPT male process threads, 304 stainless steel, 12-1/4 inch overall length with 0.260 inch bore diameter for use with 12-inch long, 1/4 inch diameter spring loaded probes with 1/2 inch NPT threaded fitting, 10-1/2 inch insertion length	1	
TW12-03	Standard duty threaded thermowell with 1/2 inch NPT male process threads, 316 stainless steel, 12-1/4 inch overall length with 0.260 inch bore diameter for use with 12-inch long, 1/4 inch diameter spring loaded probes with 1/2 inch NPT threaded fitting, 10-1/2 inch insertion length	1	
TW12-04	Standard duty threaded thermowell with 3/4 inch NPT male process threads, 316 stainless steel, 12-1/4 inch overall length with 0.260 inch bore diameter for use with 12-inch long, 1/4 inch diameter spring loaded probes with 1/2 inch NPT threaded fitting, 10-1/2 inch insertion length	1	

Note: Thermocouple extension lead wire and full listing of accessories and dimension information available at the end of this section.

Spring-Loaded Thermocouple Probe and Thermowell Assembly Example

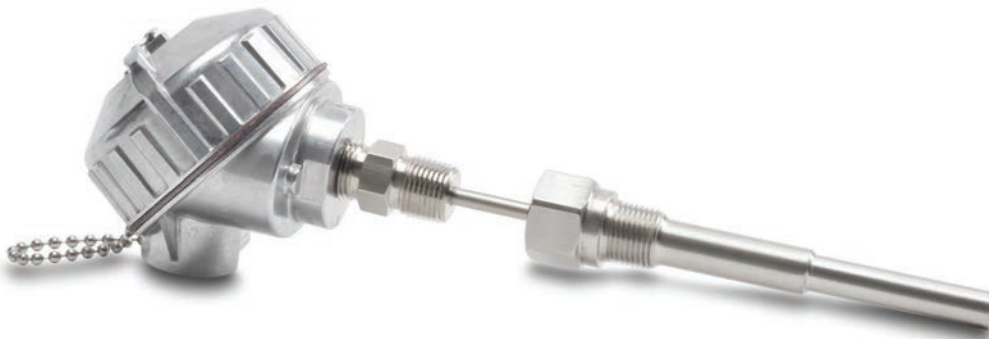

-Spring-loaded probe design ensures positive tip contact with the bottom of the thermowell.

-Integral probe hex nipple threads directly into thermowell. No additional probe mounting fittings are required.

pro^{sense}® RTD Spring-Loaded Probes with Connection Head

RTD1-CXX-03

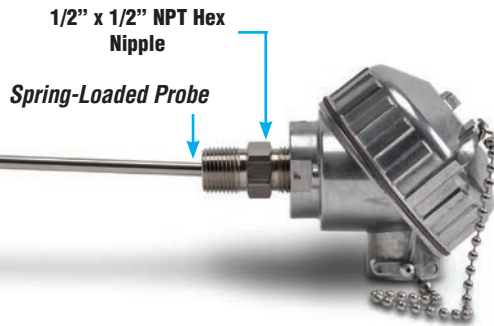

RTD1-CXX-R03
Replacement Probe



Overview

- All temperature sensors are pre-built stock items
- Probe
 - Spring-loaded for positive tip contact in thermowells
 - 100 ohm platinum RTD 3-wire element
 - Class A accuracy
 - 1/4" diameter, 316 SS sheath to protect against harsh environments
 - RTD element encased in alumina powder insulation provides excellent vibration dampening and heat transfer
 - 6", 12" or 18" probe length
- Connection Head
 - Cast aluminum NEMA 4X, IP66 screw cover head with captive gasket
 - One turn cover removal & installation eliminates cross threading and saves time
 - 3/4" NPT conduit opening with internal stop to prevent over-tightening and installation damage
 - Gripping ribs on cover edge
 - Stainless steel cover chain
- Wiring
 - Ceramic terminal base
 - Brass terminals with stainless steel screws eliminate the need to wrap connections around screws
 - Elevated terminal block for easy wire termination
- Made in the USA



RTD Spring-Loaded Probes with Connection Head								
Part Number	Pcs/Pkg	Wt (lb)	Price	Type	Probe Diameter (O.D.)	Probe Length	Temperature Sensing Range	Mounting
RTD1-C04-03	1	1.3		PT 100, 3-wire	1/4"	4"	-50 to 300°C (-58 to 572°F)	Integral 1/2" x 1/2" NPT Hex Nipple, 316 SS. Mount in thermowell (see accessories, purchased separately)
RTD1-C06-03						6"		
RTD1-C12-03						12"		

RTD Spring-Loaded Replacement Probes								
Part Number	Pcs/Pkg	Wt (lb)	Price	Type	Probe Diameter (O.D.)	Fits Probe Length	Temperature Sensing Range	For Use With
RTD1-C04R-03	1	0.2		PT 100, 3-wire	1/4"	4"	-50 to 300°C (-58 to 572°F)	RTD1-C04-03
RTD1-C06R-03						6"		RTD1-C06-03
RTD1-C12R-03						12"		RTD1-C12-03

Technical Specifications	
Sensing Element	Single 100 ohm platinum (Pt 100), 3-wire; TCR = 0.00385 ohm/ohm/°C
Initial Accuracy	Class A ±[0.15 + 0.002 t] °C
Probe	ø1/4", 316 stainless steel sheath, single RTD is embedded in alumina powder
Connection Head	Die-cast aluminum, screw cover with stainless steel chain, compressed graphite gasket, NEMA 4X, IP66, 3/4" NPT conduit opening, Max Temp: 400°F (204°C)
Response Time	7 seconds, 63% of a 25 to 77°C step change (ASTM E1137)
Wiring	Connection head: Ceramic terminal base with brass terminals and stainless steel screws (Recommended tightening torque 3-4 lb-in) Replacement Probes: 3 inch stranded 24 AWG wire leads



NOTE: CHECK THE CHEMICAL COMPATIBILITY OF THE SENSOR'S WETTED PARTS WITH THE MEDIUM TO BE MEASURED.

pro^{sense} RTD Spring-Loaded Probes with Connection Head

Dimensions

inches [mm]

RTD1-CXX-03

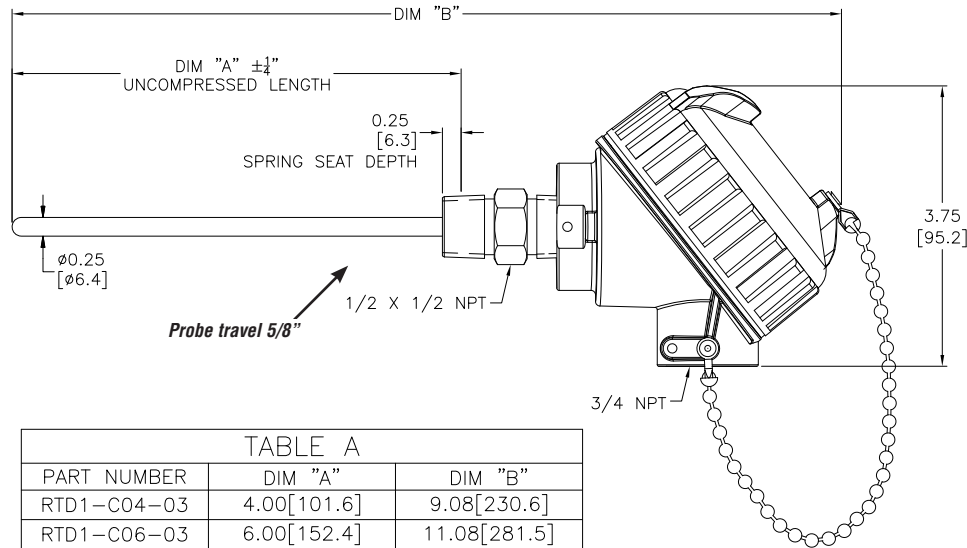

PART NUMBER	DIM "A"	DIM "B"
RTD1-C04-03	4.00[101.6]	9.08[230.6]
RTD1-C06-03	6.00[152.4]	11.08[281.5]
RTD1-C12-03	12.00[304.8]	17.08[433.8]

Wiring Information

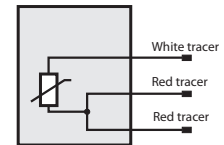
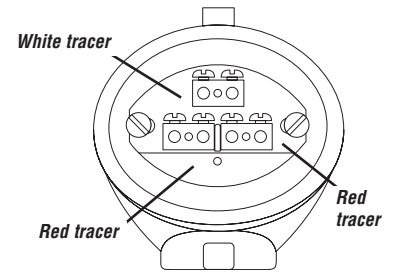

- Ignore polarity marks on terminal base
- Recommended screw terminal tightening torque 3-4 lb-in

Dimensions

inches [mm]

RTD1-CXXR-03
(Replacement Probes)

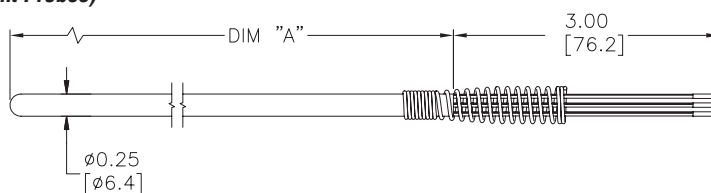

PART NUMBER	DIM "A"
RTD1-C04R-03	5.00[127.0]
RTD1-C06R-03	7.00[177.8]
RTD1-C12R-03	13.00[330.2]

Note: RTD extension lead wire available at the end of this section.
See end of section for full listing of accessories and dimension information.

Probe Replacement

1. Open top cover.
2. Disconnect wires and remove terminal block.
3. Remove snap ring at bottom of head (snap ring pliers recommended).
4. Slide out old probe and slide new probe in place.
5. While compressing spring, replace snap ring.
6. Replace terminal block and connect probe wires.

pro^sense[®] RTD Spring-Loaded Probes with Connection Head - Accessories

Accessories

Part No.	Description	Pcs/Pkg	Price
TW04-01	Standard duty threaded thermowell with 1/2 inch NPT male process threads, 304 stainless steel, 4-1/4 inch overall length with 0.260 inch bore diameter, for use with 4-inch long, 1/4 inch diameter spring loaded probes with 1/2 inch NPT threaded fitting, 2-1/2 inch insertion length	1	
TW04-02	Standard duty threaded thermowell with 3/4 inch NPT male process threads, 304 stainless steel, 4-1/4 inch overall length with 0.260 inch bore diameter for use with 4-inch long, 1/4 inch diameter spring loaded probes with 1/2 inch NPT threaded fitting, 2-1/2 inch insertion length	1	
TW04-03	Standard duty threaded thermowell with 1/2 inch NPT male process threads, 316 stainless steel, 4-1/4 inch overall length with 0.260 inch bore diameter for use with 4-inch long, 1/4 inch diameter spring loaded probes with 1/2 inch NPT threaded fitting, 2-1/2 inch insertion length	1	
TW04-04	Standard duty threaded thermowell with 3/4 inch NPT male process threads, 316 stainless steel, 4-1/4 inch overall length with 0.260 inch bore diameter for use with 4-inch long, 1/4 inch diameter spring loaded probes with 1/2 inch NPT threaded fitting, 2-1/2 inch insertion length	1	
TW06-01	Standard duty threaded thermowell with 1/2 inch NPT male process threads, 304 stainless steel, 6-1/4 inch overall length with 0.260 inch bore diameter for use with 6-inch long, 1/4 inch diameter spring loaded probes with 1/2 inch NPT threaded fitting, 4-1/2 inch insertion length	1	
TW06-02	Standard duty threaded thermowell with 3/4 inch NPT male process threads, 304 stainless steel, 6-1/4 inch overall length with 0.260 inch bore diameter for use with 6-inch long, 1/4 inch diameter spring loaded probes with 1/2 inch NPT threaded fitting, 4-1/2 inch insertion length	1	
TW06-03	Standard duty threaded thermowell with 1/2 inch NPT male process threads, 316 stainless steel, 6-1/4 inch overall length with 0.260 inch bore diameter for use with 6-inch long, 1/4 inch diameter spring loaded probes with 1/2 inch NPT threaded fitting, 4-1/2 inch insertion length	1	
TW06-04	Standard duty threaded thermowell with 3/4 inch NPT male process threads, 316 stainless steel, 6-1/4 inch overall length with 0.260 inch bore diameter for use with 6-inch long, 1/4 inch diameter spring loaded probes with 1/2 inch NPT threaded fitting, 4-1/2 inch insertion length	1	
TW12-01	Standard duty threaded thermowell with 1/2 inch NPT male process threads, 304 stainless steel, 12-1/4 inch overall length with 0.260 inch bore diameter for use with 12-inch long, 1/4 inch diameter spring loaded probes with 1/2 inch NPT threaded fitting, 10-1/2 inch insertion length	1	
TW12-02	Standard duty threaded thermowell with 3/4 inch NPT male process threads, 304 stainless steel, 12-1/4 inch overall length with 0.260 inch bore diameter for use with 12-inch long, 1/4 inch diameter spring loaded probes with 1/2 inch NPT threaded fitting, 10-1/2 inch insertion length	1	
TW12-03	Standard duty threaded thermowell with 1/2 inch NPT male process threads, 316 stainless steel, 12-1/4 inch overall length with 0.260 inch bore diameter for use with 12-inch long, 1/4 inch diameter spring loaded probes with 1/2 inch NPT threaded fitting, 10-1/2 inch insertion length	1	
TW12-04	Standard duty threaded thermowell with 3/4 inch NPT male process threads, 316 stainless steel, 12-1/4 inch overall length with 0.260 inch bore diameter for use with 12-inch long, 1/4 inch diameter spring loaded probes with 1/2 inch NPT threaded fitting, 10-1/2 inch insertion length	1	

Note: RTD extension lead wire available at the end of this section.

See end of section for full listing of accessories and dimension information.

Spring-Loaded RTD Probe and Thermowell Assembly Example



-Spring-loaded probe design ensures positive tip contact with the bottom of the thermowell.

-Integral probe hex nipple threads directly into thermowell. No additional probe mounting fittings are required.

pro^oense[®] Compression Mounting Fittings for Temperature Probes

Compression Mounting Fittings for Temperature Probes				
Part Number	Description	Pcs/ Pkg	Wt(lb)	Price
BCF18-125N	Compression fitting, brass, for 1/8 inch diameter temperature probes, 1/8 inch NPT male thread	1	0.5	
BCF14-125N	Compression fitting, brass, for 1/4 inch diameter temperature probes, 1/8 inch NPT male thread	1	0.5	
BCF18-25N	Compression fitting, brass, for 1/8 inch diameter temperature probes, 1/4 inch NPT male thread	1	0.5	
BCF14-25N	Compression fitting, brass, for 1/4 inch diameter temperature probes, 1/4 inch NPT male thread	1	0.5	
BCF18-50N	Compression fitting, brass, for 1/8 inch diameter temperature probes, 1/2 inch NPT male thread	1	0.5	
BCF14-50N	Compression fitting, brass, for 1/4 inch diameter temperature probes, 1/2 inch NPT male thread	1	0.5	
CF18-125N	Compression fitting, 316 stainless steel, for 1/8 inch diameter temperature probes, 1/8 inch NPT male thread	1	0.5	
CF14-125N	Compression fitting, 316 stainless steel, for 1/4 inch diameter temperature probes, 1/8 inch NPT male thread	1	0.5	
CF18-25N	Compression fitting, 316 stainless steel, for 1/8 inch diameter temperature probes, 1/4 inch NPT male thread	1	0.5	
CF14-25N	Compression fitting, 316 stainless steel, for 1/4 inch diameter temperature probes, 1/4 inch NPT male thread	1	0.5	
CF18-50N	Compression fitting, 316 stainless steel, for 1/8 inch diameter temperature probes, 1/2 inch NPT male thread	1	0.5	
CF14-50N	Compression fitting, 316 stainless steel, for 1/4 inch diameter temperature probes, 1/2 inch NPT male thread	1	0.5	
CFTF-18	Teflon™ ferrule for brass or stainless steel compression fittings and 1/8 diameter temperature probes	5	0.5	
CFTF-14	Teflon ferrule for brass or stainless steel compression fittings and 1/4 diameter temperature probes	5	0.5	
CF06-25N	1/4 NPT stainless steel compression fitting for 0.24 inch (6 mm) diameter RTD probe with M12 connector.	1	0.18	
CF10-50N	1/2 NPT stainless steel compression fitting for 10 mm (0.4 inch) diameter RTD probe with M12 connector.	1	0.20	
CF18-BC	Bayonet compression fitting, for 1/8" diameter probe sheath sensors	1	0.1	
BB125N-50N	Reducing bushing, brass, 1/2 MNPT x 1/8 FNPT, hex head	1	0.1	



NOTE: CHECK THE CHEMICAL COMPATIBILITY OF THE SENSOR'S WETTED PARTS WITH THE MEDIUM TO BE MEASURED.

**Working pressure of compression fitting should not exceed 500 psi. However we recommend any pressure application use a thermowell*

CF14-125N



CF14-50N



CF14-25N



CF18-BC



CF06-25N



CF10-50N



BCF18-125N



BCF18-25N



BCF18-50N



BB125N-50N



CFTF-14



CFTF-18



pro^{sense}® Compression Mounting Fittings for Temperature Probes

BCF14-125N



BCF14-25N



BCF14-50N



CF18-25N



CF18-50N



CF18-125N



Dimensions

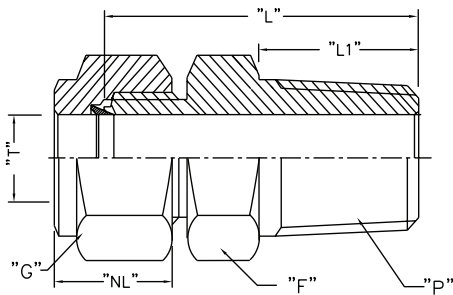

Note: All threaded connections should be hand tightened and then turned 1 to 2 full turns for proper sealing.

Actual torque required for a proper seal of NPT threads is influenced by tolerance, sealant, lubricant, etc.

ProSense Compression Fittings									
Part No.	Weight (lb)	Description	"T" Tube O.D.	"P" NPT(M)	"L" Body Length*	"L1" Thread Length**	"F" Body Hex**	"G" Nut Hex**	"NL" Nut Length**
BCF18-125N/CF18-125N	0.5	1/8" OD x 1/8" NPT(M)	0.128/0.132	1/8" NPT(M)	0.909"	0.393"	0.5"	0.433"	0.492"
BCF14-125N/CF14-125N	0.5	1/4" OD x 1/8" NPT(M)	0.253/0.257	1/8" NPT(M)	1.0"	0.393"	0.5"	0.559"	0.5"
BCF18-25N/CF18-25N	0.5	1/8" OD x 1/4" NPT(M)	0.128/0.132	1/4" NPT(M)	1.114"	0.551"	0.551"	0.433"	0.492"
BCF14-25N/CF14-25N	0.5	1/4" OD x 1/4" NPT(M)	0.253/0.257	1/4" NPT(M)	1.188"	0.551"	0.551"	0.559"	0.5"
BCF18-50N/CF18-50N	0.5	1/8" OD x 1/2" NPT(M)	0.128/0.132	1/2" NPT(M)	1.377"	0.748"	0.866"	0.433"	0.492"
BCF14-50N/CF14-50N	0.5	1/4" OD x 1/2" NPT(M)	0.253/0.257	1/2" NPT(M)	1.437"	0.748"	0.866"	0.559"	0.5"
CF06-25N	0.18	6 mm OD x 1/4" NPT(M)	0.236/0.240	1/4" NPT(M)	1.174"	0.59"	0.67"	0.55"	0.587"
CF10-50N	0.20	10 mm OD x 1/2" NPT(M)	0.394/0.399	1/2" NPT(M)	1.458"	0.55"	1.06"	0.75"	0.608"

Note: All dimensions are in inches

** ± 0.07*

*** ± 0.03*

Note: Once the compression fitting has been fully tightened on the probe, the ferrule will be locked onto the probe and cannot be removed or reused.

**Working pressure of compression fitting should not exceed 500 psi. However we recommend any pressure application use a thermowell*



Scan the QR Code or click to view the CF06 & CF10 Compression Fitting Installation Instructions

Bayonet Mounting Adapter for Temperature Sensors

Bayonet Mounting Adapter for Temperature Sensors					
Part Number	Description	Material	Pcs/Pkg	Wt(lb)	Price
BA-078	Bayonet adapter, 7/8 inch long, 7/16 inch outside diameter, 9/32 inch inside diameter, 1/8 inch MNPT	Stainless Steel (304)	1	0.5	
BA-100	Bayonet adapter, 1 inch long, 7/16 inch outside diameter, 9/32 inch inside diameter, 1/8 inch MNPT		1	0.5	
BA-114	Bayonet adapter, 1-1/4 inch long, 7/16 inch outside diameter, 9/32 inch inside diameter, 1/8 inch MNPT		1	0.5	
BA-112	Bayonet adapter, 1-1/2 inch long, 7/16 inch outside diameter, 9/32 inch inside diameter, 1/8 inch MNPT		1	0.5	
BA-200	Bayonet adapter, 2 inch long, 7/16 inch outside diameter, 9/32 inch inside diameter, 1/8 inch MNPT		1	0.5	
BA-212	Bayonet adapter, 2-1/2 inch long, 7/16 inch outside diameter, 9/32 inch inside diameter, 1/8 inch MNPT		1	0.5	
BA-300	Bayonet adapter, 3 inch long, 7/16 inch outside diameter, 9/32 inch inside diameter, 1/8 inch MNPT		1	0.5	
BA-312	Bayonet adapter, 3-1/2 inch long, 7/16 inch outside diameter, 9/32 inch inside diameter, 1/8 inch MNPT		1	0.5	
CF18-BC	Adjustable bayonet compression fitting, for 1/8" diameter probe sheath sensors		1	0.1	
BB125N-50N	Reducing bushing, 1/2 MNPT x 1/8 FNPT, hex head	Brass	1	0.1	



NOTE: CHECK THE CHEMICAL COMPATIBILITY OF THE SENSOR'S WETTED PARTS WITH THE MEDIUM TO BE MEASURED.

BA-078



BA-100



BA-114



CF18-BC



BA-300



BA-112



BB125N-50N



BA-312



BA-200



BA-212



proSense® Pipe Clamp Adapters



PCA-300

Overview

- For use with ProSense adjustable immersion thermocouple and RTD sensors
- Available in adjustable diameters from 11/16 to 7 inches
- Provides an easy means of sensing temperature on the outside of a pipe



Shown with optional adjustable immersion sensor

Pipe Clamp Adapters for ProSense Adjustable Immersion Sensors				
Part Number	Description	Pcs/ Pkg	Wt(lb)	Price
PCA-125	ProSense pipe clamp adapter, 11/16 to 1-1/4 inch adjustable diameter, 2-inch attached bayonet adapter with 7/16 inch outside diameter and 9/32 inch inside diameter. Use with ProSense adjustable immersion sensors.	1	0.1	
PCA-200	ProSense pipe clamp adapter with 1-1/16 to 2 inch adjustable diameter, 2-inch attached bayonet adapter with 7/16 inch outside diameter and 9/32 inch inside diameter. Use with ProSense adjustable immersion sensors.	1	0.1	
PCA-300	ProSense pipe clamp adapter with 2-1/16 to 3 inch adjustable diameter, 2-inch attached bayonet adapter with 7/16 inch outside diameter and 9/32 inch inside diameter. Use with ProSense adjustable immersion sensors.	1	0.1	
PCA-425	ProSense pipe clamp adapter with 3-5/16 to 4-1/4 inch adjustable diameter, 2-inch attached bayonet adapter with 7/16 inch outside diameter and 9/32 inch inside diameter. Use with ProSense adjustable immersion sensors.	1	0.1	
PCA-500	ProSense pipe clamp adapter with 4-1/8 to 7 inch adjustable diameter, 2-inch attached bayonet adapter with 7/16 inch outside diameter and 9/32 inch inside diameter. Use with ProSense adjustable immersion sensors.	1	0.1	

Dimensions

inches [mm]

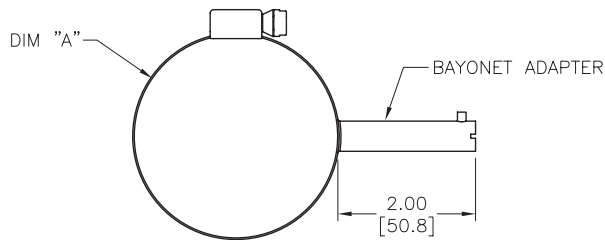

PART NUMBER	DIM "A"	FITS PIPE SIZES
PCA-125	ø0.68–1.25 [ø17.2–31.7]	1/2 TO 3/4 NPS
PCA-200	ø1.06–2.00 [ø26.9–50.8]	1 TO 1-1/2 NPS
PCA-300	ø2.06–3.00 [ø52.3–76.2]	2 TO 2-1/2 NPS
PCA-425	ø3.31–4.25 [ø84.1–108.0]	3 TO 3-1/2 NPS
PCA-500	ø4.12–7.00 [ø104.6–177.8]	4 TO 6 NPS

pro^{sense} Thermocouple and RTD Connectors

Overview

- Glass-filled high quality thermoplastic body with original thermocouple material pins and spring-loaded inserts
- Polarized pins
- Molded barriers prevent short circuit
- Captive central cover screw for easy assembly
- Easy wire connection pressure plate construction
- Stainless steel screws with combination head (Slotted and Phillips)
- 3-pin standard connectors have a third pin for ground or continuous shield, or for 3-wire RTDs



Thermocouple and RTD Connectors									
Part Number	Pcs/ Pkg	Wt(lb)	Price	Sensor Type	Connector Type	Temperature Rating	Body Color	Wire Size	Wire Cable Clamp Bracket
THMJ-SP	1	0.5		J	Standard round pin plug	Max continuous 400°F (200°C)	Black	32 AWG (0.2 mm) to 14 AWG maximum (2.0 mm)	WCB-S
THMJ-SJ	1	0.5	Standard round pin jack		–				
THMJ-SPJ	1	0.5	Standard round direct mount jack		–				
THMJ-MP	1	0.5	Miniature flat pin plug		40 AWG (0.08 mm) to 20 AWG maximum (0.8 mm)			WCB-M	
THMJ-MJ	1	0.5	Miniature flat pin jack					–	
THMJ-MPJ	1	0.5	Miniature round direct mount jack					–	
THMK-SP	1	0.5		K	Standard round pin plug	Max continuous 662°F (350°C)	Yellow	32 AWG (0.2 mm) to 14 AWG maximum (2.0 mm)	WCB-S
THMK-SJ	1	0.5	Standard round pin jack		–				
THMK-SPJ	1	0.5	Standard round direct mount jack		–				
THMK-MP	1	0.5	Miniature flat pin plug		40 AWG (0.08 mm) to 20 AWG maximum (0.8 mm)			WCB-M	
THMK-MJ	1	0.5	Miniature flat pin jack					–	
THMK-MPJ	1	0.5	Miniature round direct mount jack					–	
THMK-HSP	1	0.5		RTD	Standard hi-temp round pin plug	Max continuous 662°F (350°C)	Brown	32 AWG (0.2 mm) to 14 AWG maximum (2.0 mm)	WCB-S
THMK-HSJ	1	0.5	Standard hi-temp round pin jack		–				
THMT-SP	1	0.5		T	Standard round pin plug	Max continuous 400°F (200°C)	Blue	32 AWG (0.2 mm) to 14 AWG maximum (2.0 mm)	WCB-S
THMT-SJ	1	0.5	Standard round pin jack		–				
THMT-SPJ	1	0.5	Standard round direct mount jack		–				
THMT-MP	1	0.5	Miniature flat pin plug		40 AWG (0.08 mm) to 20 AWG maximum (0.8 mm)			WCB-M	
THMT-MJ	1	0.5	Miniature flat pin jack					–	
THMT-MPJ	1	0.5	Miniature round direct mount jack					–	
RTD-SP	1	0.5		RTD	Standard round pin plug	Max continuous 400°F (200°C)	White	32 AWG (0.2 mm) to 14 AWG maximum (2.0 mm)	WCB-S
RTD-SJ	1	0.5	Standard round pin jack		–				

THMT-SP



THMT-SJ



THMK-SP



THMK-SJ



THMJ-MP



THMJ-MJ



THMT-SPJ



THMT-MPJ



RTD-SP



RTD-SJ



THMK-HSP



THMK-HSJ



pro^{sense} Thermocouple and RTD Connectors

Dimensions

inches [mm]

THMJ, K, T, & H-SP

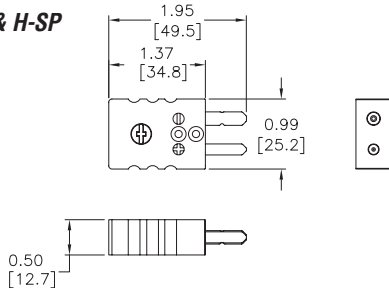

THMJ, K, T, & H-SJ

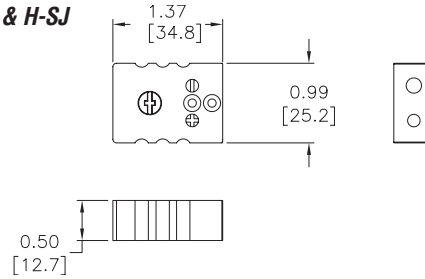

THMJ, K, & T-MP

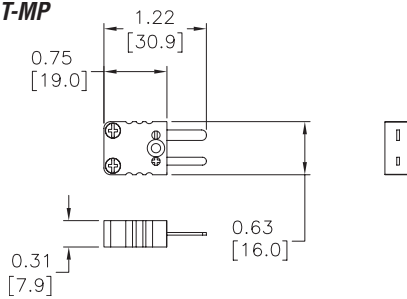

THMJ, K, & T-MJ

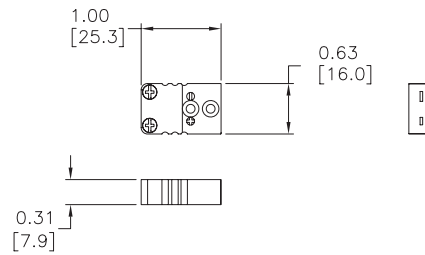

THMJ, K, & T-SPJ

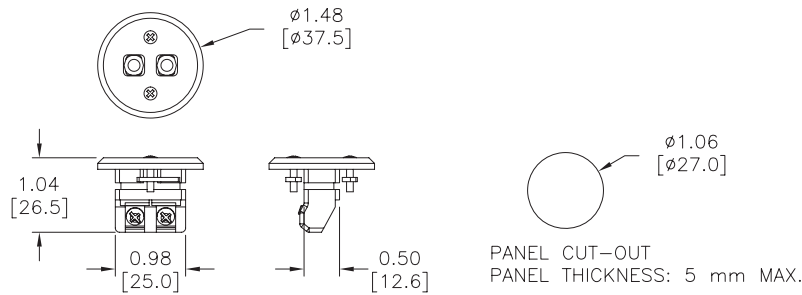

THMJ, K, & T-MPJ

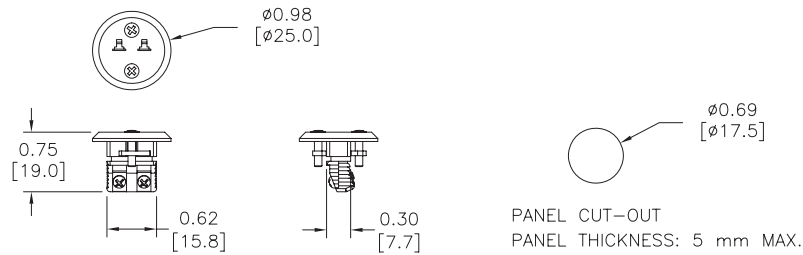

RTD-SP

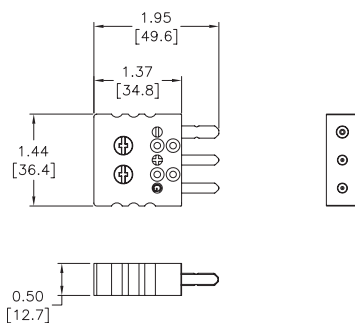

RTD-SJ

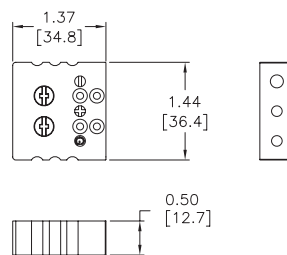

pro^{sense} Thermocouple and RTD Connectors

WCB-S



WCB-M



WCB-S Application



WCB-M Application



Thermocouple and RTD Connectors Accessories				
Part Number	Pcs/ Pkg	Wt(lb)	Price	Description
WCB-S	4	0.5		Wire / cable clamp bracket for use with standard thermocouple and RTD connectors.
WCB-M	4	0.5		Wire / cable clamp bracket for use with miniature thermocouple connectors.

Dimensions

inches [mm]

WCB-S

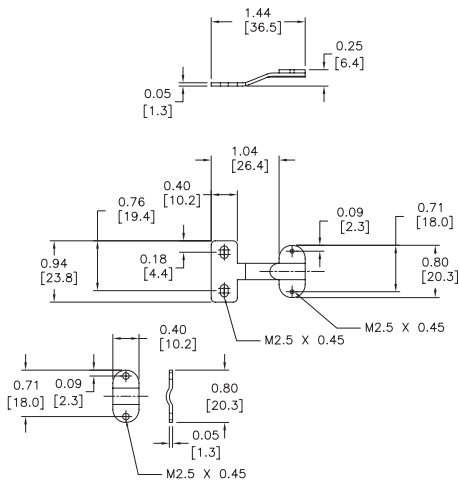

WCB-M

