

Screwless Ground Terminal Blocks

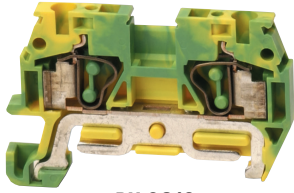

DN-QG12
(Euro QE2.5/35)

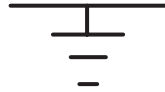

Ground terminal blocks are used to mechanically and electrically connect wires to the DIN rail by means of a conducting clamping foot. In this way, the DIN rail can function as a ground bus bar.

Ground blocks are molded in green and yellow per international standards and are 35mm DIN-rail mountable.

Ordering Information

	Part Number	Qty	Price	Part Number	Qty	Price	Part Number	Qty	Price
Green/Yellow Block	DN-QG12	10		DN-QG10	10		DN-QG8	10	

Technical Specifications

Stripping Length	12mm [0.47 in]	15mm [0.59 in]	18mm [0.71 in]
Density	200/m [60 pcs/ft]	166/m [50 pcs/ft]	125/m [38 pcs/ft]
UL Approval	24-12 AWG	24-10 AWG	22-8 AWG
CSA Approval	24-12 AWG	24-10 AWG	22-8 AWG
VDE Approval	2.5 mm ²	4mm ²	6mm ²
Operating Temperature	Ambient air temperature: -20 to 105°C [-4 to 221°F] / Relative humidity: 50% max at 40°C [104°F]; 90% max at 20°C [68°F]		
SCCR Rating	10kA per Table SB4.1, 2009, UL 508A, Maximum short circuit current rating for unmarked components		
CE Conformity	CE (EN 60947-1 / EN 60947-7-2)		
Agency File #	UL E179129		

Note: To obtain the most current agency approval information, see the Agency Approval Checklist section on the specific part number's web page.

Accessories

End Cover	DN-QEC12	50		DN-QEC10	50		DN-QEC8	50	
	DN-QEC12MN	10		DN-QEC10MN	10		DN-QEC8MN	10	
35mm DIN Rail	DN-R35S1	10		DN-R35S1	10		DN-R35S1	10	
	DN-R35S1-2	2		DN-R35S1-2	2		DN-R35S1-2	2	
End Brackets	DN-EB35	50		DN-EB35	50		DN-EB35	50	
	DN-EB35MN	20		DN-EB35MN	20		DN-EB35MN	20	
	DN-EB35-A	50		DN-EB35-A	50		DN-EB35-A	50	
	DN-EB35-A-10	10		DN-EB35-A-10	10		DN-EB35-A-10	10	
	DN-QEB35	50		DN-QEB35	50		DN-QEB35	50	
	DN-QEB35-10	10		DN-QEB35-10	10		DN-QEB35-10	10	
Angled Support Bracket	DN-ASB1	50		DN-ASB1	50		DN-ASB1	50	
Marking Tags	DN-QL Series	500	various	DN-QL Series	500	various	DN-QL Series	500	various

Note: For more information on accessories, see the DINnectors Accessories section of this chapter.

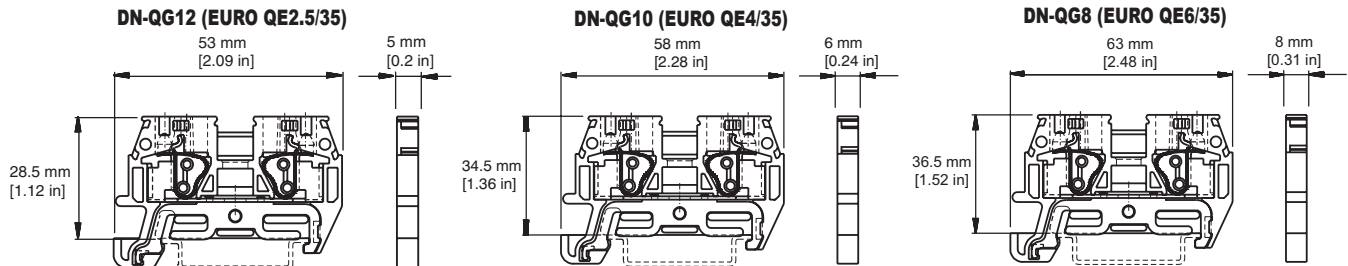

DINnectors Screwless Ground Terminal Blocks

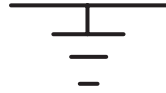

Ordering Information						
	Part Number	Qty	Price	Part Number	Qty	Price
Green/Yellow Block	<u>DN-QG12-1-2</u>	10		<u>DN-QG12-2-2</u>	10	
Technical Specifications						
Stripping Length	12mm [0.47 in]		12mm [0.47 in]			
Density	200/m [60 pcs/ft]		200/m [60 pcs/ft]			
UL Approval	24-12 AWG		24-12 AWG			
CSA Approval	24-12 AWG		24-12 AWG			
VDE Approval	2.5 mm ²		2.5 mm ²			
Operating Temperature	Ambient air temperature: -20 to 105°C [-4 to 221°F] Relative humidity: 50% max at 40°C [104°F]; 90% max at 20°C [68°F]					
SCCR Rating	10kA per Table SB4.1, 2009, UL 508A, Maximum short circuit current rating for unmarked components					
CE Conformity	CE (EN 60947-1 / EN 60947-7-2)					
Agency File #	UL E179129					

Note: To obtain the most current agency approval information, see the Agency Approval Checklist section on the specific part number's web page.

Accessories						
End Cover	<u>DN-QEC12-1-2</u>	25		<u>DN-QEC12-2-2</u>	25	
35mm DIN Rail	<u>DN-R35S1</u>	10		<u>DN-R35S1</u>	10	
	<u>DN-R35S1-2</u>	2		<u>DN-R35S1-2</u>	2	
End Brackets	<u>DN-EB35</u>	50		<u>DN-EB35</u>	50	
	<u>DN-EB35MN</u>	20		<u>DN-EB35MN</u>	20	
	<u>DN-EB35-A</u>	50		<u>DN-EB35-A</u>	50	
	<u>DN-EB35-A-10</u>	10		<u>DN-EB35-A-10</u>	10	
	<u>DN-QEB35</u>	50		<u>DN-QEB35</u>	50	
	<u>DN-QEB35-10</u>	10		<u>DN-QEB35-10</u>	10	
Angled Support Bracket	<u>DN-ASB1</u>	50		<u>DN-ASB1</u>	50	
Marking Tags	<u>DN-QL-Series</u>	500	various	<u>DN-QL Series</u>	500	various

Note: For more information of accessories, see the DINnectors Accessories section of this chapter.

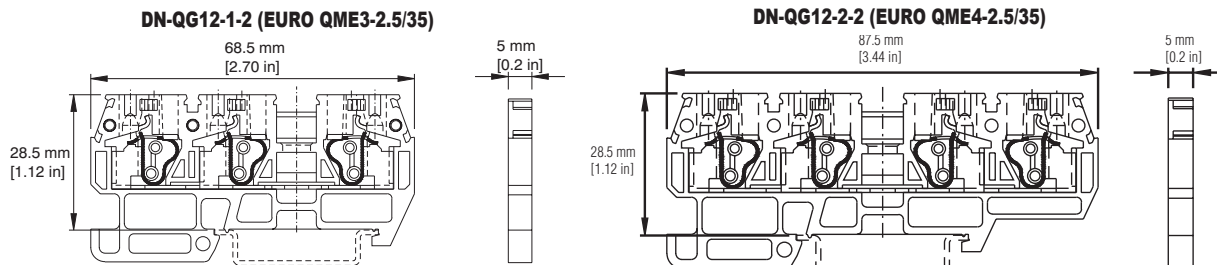

Screwless Terminal Blocks Overview

Why go screwless?

Screwless clamping technology offers several benefits:

- Speed: On average, screwless connections can be made in half the time of screw type connections, cutting installation labor costs in half.
- Ease: No need for twisting and turning screws, so screwless terminal blocks are much easier on the installer's hands and arms. Also, wiring from the top of the terminal blocks allow installers to accurately and reliably see the wire fully inserted into the spring clamp.
- Safety: Never have a problem with faulty connections from loose screws again! Meets the same UL, CSA, and IEC standards as screw-type terminal blocks.
- Maintenance-free: The screwless spring clamp conforms to the wire with constant tension, making it maintenance-free.

Are there any trade-offs of going screwless versus screw-type?

Unless you need to clamp multiple wires to the same connection point, the answer is no. If you do, then there may be a slight trade-off in requiring more panel space than with screw terminal blocks. Unlike screw terminal blocks, screwless terminal block spring-clamps are designed to clamp a single wire, only. This is why multiple versions exist like the "one-to-two" or "two-to-two." These versions allow multiple wires to be connected together via multiple spring clamps.

How does it work?

Well, it's pretty simple: Push, Insert, Release. Just push your screwdriver into the spring clamp (a rectangular shaped hole) to open the spring clamp; insert the stripped wire into the clamp (a circular shaped hole), and pull out your screwdriver to release the clamp against the wire. That's it. The connection is made.

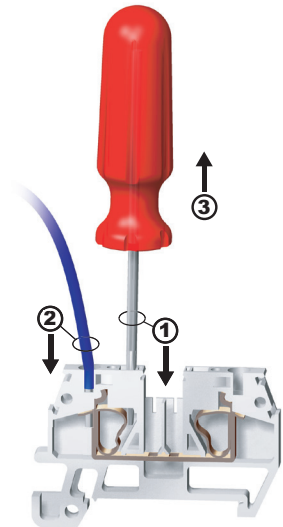

How do the jumpers work?

1

Properly align jumper bar with terminal block center jumper slots.

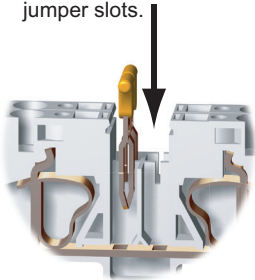

2

Push down until firmly seated.

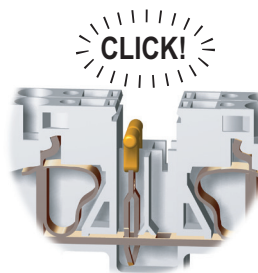

Removal

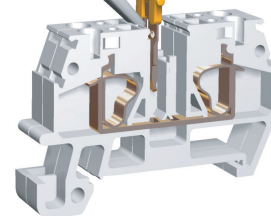

Yes



No

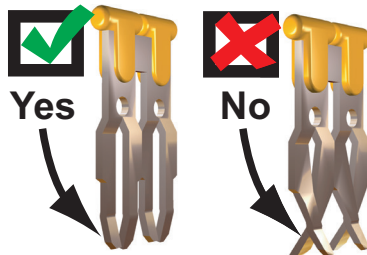

Yes = Good, acceptable jumper
No = Bad, damaged jumper

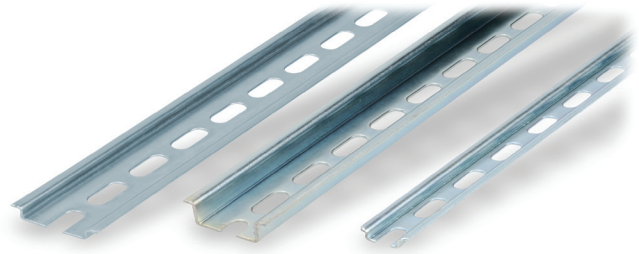

Steel DIN Rails Features

35mm wide

- Available in 1-meter lengths
- 7.5 mm-high rails primarily used to mount terminal blocks, relays, timers and small PLCs such as the DL05, DL06, DL105, DL205, CLICK, and Productivity3000
- 15mm-high rails for mounting larger and heavier components such as contactors and larger PLCs

15mm wide

- Available in 1-meter lengths
- DN-R15S1 exclusively for mounting mini terminal blocks such as the DN-M10-A

Steel DIN Rails Specifications									
	Part Number	Qty	Price	Part Number	Qty	Price	Part Number	Qty	Price
DIN Rail	<u>DN-R35S1</u>	10		<u>DN-R35HS1</u>	10		<u>DN-R15S1</u>	10	
	<u>DN-R35S1-2</u>	2		<u>DN-R35HS1-2</u>	2		<u>DN-R15S1-2</u>	2	
Description	DINnector DIN rail, slotted, 35mm, 7.5mm height, 1m length, plated steel. Package of 10.			DINnector DIN rail, slotted, 35mm, 15mm height, 1m length, plated steel. Package of 10.			DINnector DIN rail, slotted, 15mm, 5.5mm height, 1m length, plated steel. Package of 2.		
Plating	Zinc-plated and chromated								
International Standards	EN 60715, RoHs								
Suggested Mounting Screw Type	M6			M6			M4		

Aluminum DIN Rail Features

35mm wide

- Non-anodized finish
- Zinc plating and passivation (minimum thickness 6 microns)
- Lightweight, easy to cut and deburr
- Terminal blocks only
- Maximum mounting screw #10-32 or M5
- Available in 1-meter lengths

35mm wide raised

- Non-anodized finish
- Zinc plating and passivation (minimum thickness 6 microns)
- Enables users to raise terminal blocks 2¼" above the back panel
- Terminal blocks only
- Available in 1-meter lengths
- Bushing or grommet recommended for wire access hole (example Heyco UB-875 not sold by ADC)

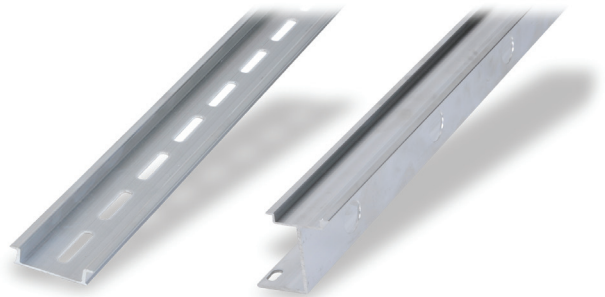

Aluminum DIN Rails Specifications						
	Part Number	Qty	Price	Part Number	Qty	Price
DIN Rail	<u>DN-R35SAL1</u>	10		<u>DN-R35SAL2-2</u>	2	
	<u>DN-R35SAL1-2</u>	2				
Description	DINnector DIN rail, slotted, 35mm, 10mm height, 1m length, aluminum. Package of 10.			DINnector DIN rail, slotted, 2in raised 35mm, 7.5mm height, 1m length, aluminum. Package of 2.		
Plating	Galvanic zinc plating, non-anodized finish					
International Standards	DIN 50960, RoHs					
Suggested Mounting Screw Type	#10-32 or M5					

DIN rail support brackets

- Angled support brackets raise and tilt mounting rails 30 degrees from mounting surface for easier wiring
- DN-ASB1 plated steel support bracket
- DN-ASB2-10 cold-rolled steel treated with galvanic zinc plating and passivation

DIN rail mounting clips

- Snap small devices not made for mounting onto 35mm DIN rails
- Zinc plated steel

DIN Rail Support Brackets and Mounting Clips			
Part Number	Description	Qty	Price
<u>DN-ASB1</u>	30° angled DIN rail support bracket (M6-1.0 screws not included)	50	
<u>DN-ASB2-10</u>	30° angled DIN rail support bracket (M6-1.0 screws included)	10	
<u>DN-SSB25-10</u>	1" (25 mm) DIN rail support bracket (M6-1.0 screws included)	10	
<u>DN-SSB50-10</u>	2" (50 mm) DIN rail support bracket (M6-1.0 screws included)	10	
<u>DN-SSB70-10</u>	2.75" (70 mm) DIN rail support bracket (M6-1.0 screws included)	10	
<u>DN-SSB90-10</u>	3.5" (90 mm) DIN rail support bracket (M6-1.0 screws included)	10	
<u>DN-CLIP-FM4</u>	DIN rail mounting clip with M4 x 0.7 mm threaded hole (Screws not included)	40	
<u>DN-CLIP-FM4-5</u>		5	
<u>DN-CLIP-FM5</u>	DIN rail mounting clip with M5 x 0.8 mm threaded hole (Screws not included)	40	
<u>DN-CLIP-FM5-5</u>		5	



DN-ASB1



DN-ASB2-10



DN-SSB25-10



DN-SSB50-10



DN-SSB70-10



DN-SSB90-10



**DN-CLIP-FM4
DN-CLIP-FM4-5**



**DN-CLIP-FM5
DN-CLIP-FM5-5**

DIN Rail Support Brackets and Mounting Clips

Dimensions mm [inches]

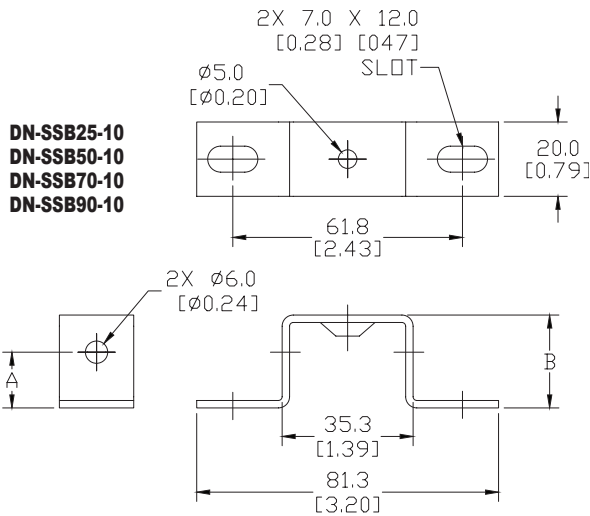
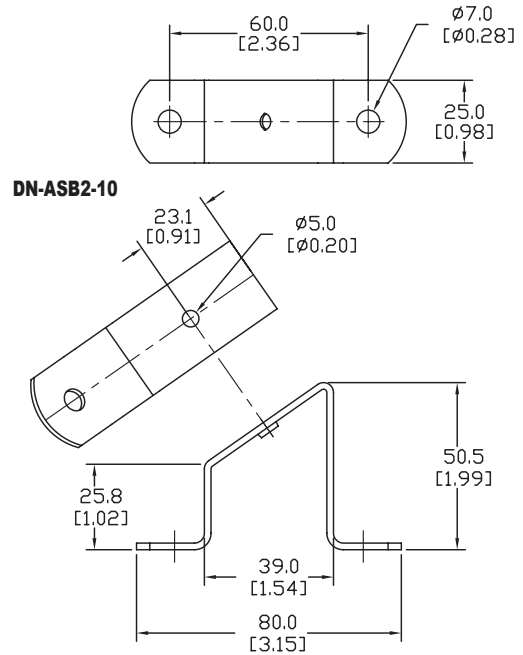
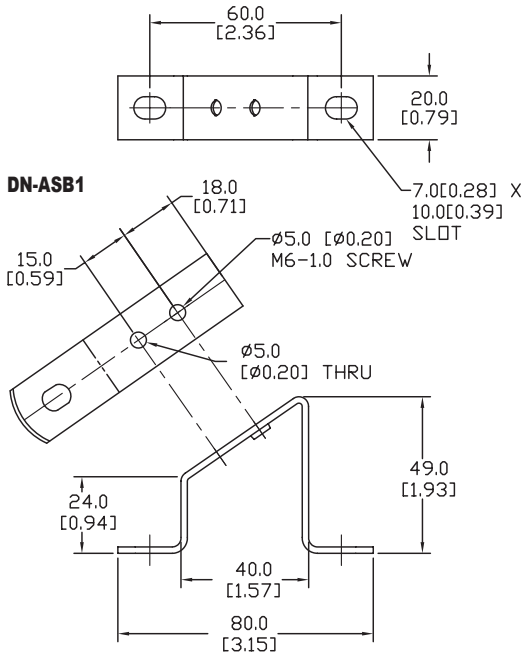

DIN Rail Support Brackets		
Part Number	DIM A mm [inches]	DIM B mm [inches]
DN-SSB25-10	15.0 [0.59]	25.0 [0.98]
DN-SSB50-10	40.0 [1.58]	50.0 [1.97]
DN-SSB70-10	60.0 [2.36]	70.0 [2.76]
DN-SSB90-10	80.0 [3.15]	90.0 [3.54]

See our website: for complete engineering drawings

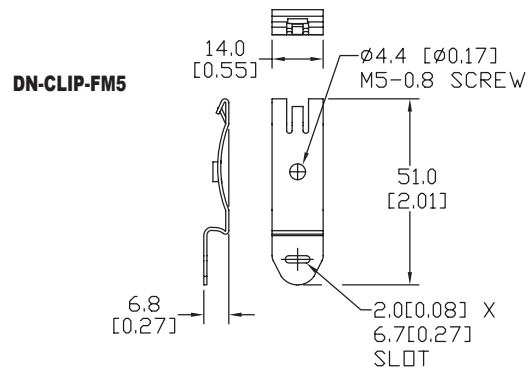
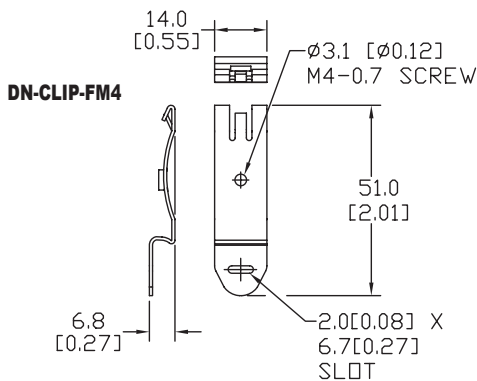

Jumpers

Multi-pole jumper bars for DINnector terminal blocks

Multi-pole Jumper Bars										
Part Number	Qty	Price	Part Number	Qty	Price	# of Poles	Rating		Insulation Color	For Use With Terminal Block Series
							(V)	(A)		
DN-2J2YMN	25		DN-2J2Y	100		2	600	25	Orange	DN-T12-A, DN-EMX, DN-Q12-A, DN-QD12-A, DN-QEMX, DN-QKBD12-A
DN-2J4YMN	25		DN-2J4Y	100		2	600	25	Yellow	DN-T10-A, DN-D10-A, DN-M10-A, DN-Q10-A
DN-2J6YMN	25		DN-2J6Y	100		2	600	30	Green	DN-Q8-A
-	-	-	DN-2J6	100		2	600	65	-	DN-T6
DN-2JL14-AMN	25		DN-2JL14-A	100		2	300	20	Red	DN-TL-A
DN-2JL14B-AMN	25		DN-2JL14B-A	100		2	300	20	Blue	DN-TL-A
DN-3J2YMN	25		DN-3J2Y	100		3	600	25	Orange	DN-T12-A, DN-EMX, DN-Q12-A, DN-QD12-A, DN-QEMX, DN-QKBD12-A
DN-3J4YMN	25		DN-3J4Y	100		3	600	25	Yellow	DN-T10-A, DN-D10-A, DN-M10-A, DN-Q10-A
DN-3J6YMN	25		DN-3J6Y	100		3	600	30	Green	DN-Q8-A
-	-	-	DN-3J6	100		3	600	65	-	DN-T6
DN-3JL14-AMN	25		DN-3JL14-A	100		3	300	20	Red	DN-TL-A
DN-3JL14B-AMN	25		DN-3JL14B-A	100		3	300	20	Blue	DN-TL-A
			DN-4J6	100		4	600	65	-	DN-T6
			DN-12J6Y	10		12	600	30	Green	DN-Q8-A
			DN-12JL14-A	10		12	300	20	Red	DN-TL-A
			DN-12JL14B-A	10		12	300	20	Blue	DN-TL-A
			DN-12JFE	10		12	300	25	Blue	DN-FE4
			DN-24J2Y	5		24	600	25	Yellow	DN-T12-A, DN-EMX, DN-Q12-A, DN-QD12-A, DN-QEMX, DN-QKBD12-A
			DN-24J4Y	5		24	600	25	Yellow	DN-T10-A, DN-D10-A, DN-M10-A, DN-Q10-A
			DN-24J8	5		24	600	50	Green	DN-T8
			DN-55J6	1		55	600	65	-	DN-T6

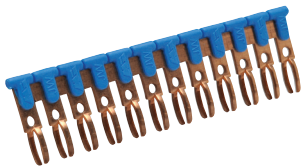

DN-12JL14B-A

Dimensions mm [inches]

DN-xJ2Y / DN-xJ2YMN

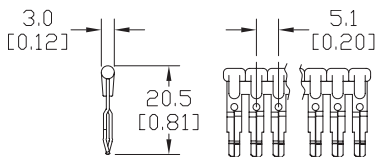

DN-xJ6Y / DN-xJ6YMN

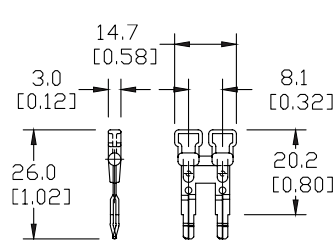

DN-xJ4Y / DN-xJ4YMN

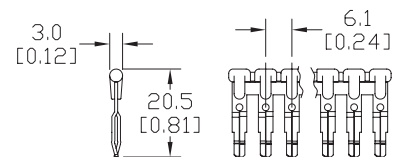

DN-24J8

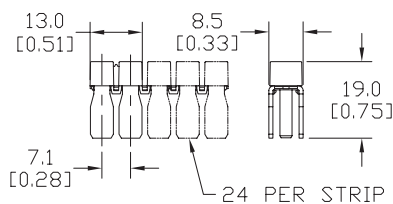

DN-12JFE

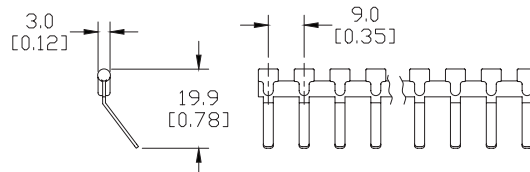

DN-xJL14 / DN-xJL14x-AMN
DN-xJ14x-A

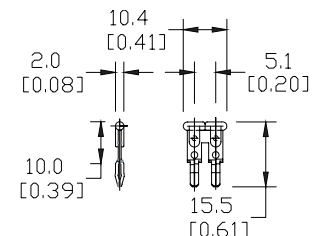

Modifying a DN-24J8 jumper bar to the required number of poles

1) Place the insulating part into the jumper bar and insert screws, based on number of poles required. (For instance, in the following example, 5 poles are required). Click into place.



2) Using a cutting tool, cut the insulating part at the edge of the jumper bar (see below).

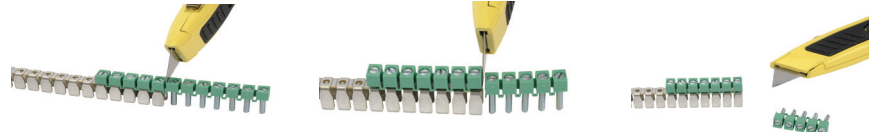

3) Hold the metal jumper bar and insulating jumper with two hands, placing fingers to the left and right of the pole you wish to cut, repeatedly flexing up and down (1 or 2 times should be sufficient) until the jumper bar and insulating jumper break in two.

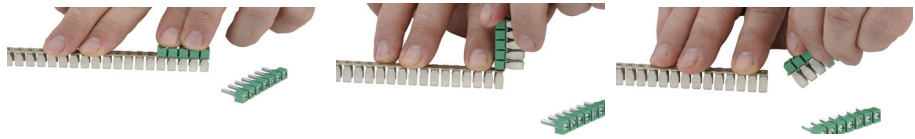

4) Remove the small remaining piece of jumper (see below). This is important to ensure appropriate insulation distance in the case of contiguously applied jumpers in sequence. This step also facilitates the placement of a separator terminal if the bridge is positioned as the last terminal of a group.

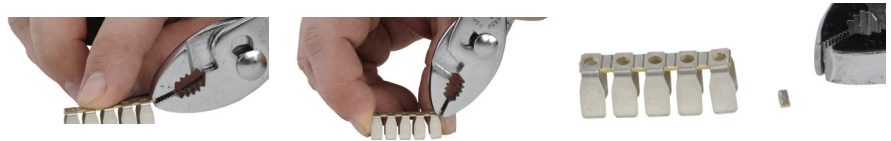

5) The jumpers now are ready to be screwed onto DN-T8 series terminal blocks.

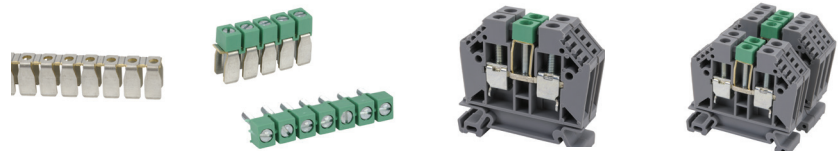

Jumper Cutting Tools

Jumper cutting tools maintain protective covering.

Jumper Cutting Tools			
Part Number	Description	Qty	Price
<u>DN-J2CUT</u>	Cutting tool for DN-2J2Y, DN-3J2Y and DN-24J2Y jumpers.	1	
<u>DN-J4CUT</u>	Cutting tool for DN-2J4Y, DN-3J4Y and DN-24J4Y jumpers.	1	
<u>DN-J6CUT</u>	Cutting tool for DN-12J6Y jumpers.	1	
<u>DN-JL14CUT</u>	Cutting tool for DN-12JL14-A and DN-12JL14B-A jumpers.	1	
<u>DN-JXCUT</u>	Cutting tool without dies for DN-J12DIE, DN-J4DIE, DN-J6DIE, DN-JL14DIE AND DN-JFEDIE dies. Order dies separately.	1	
<u>DN-JFECUT</u>	Cutting tool for DN-12JFE	1	
<u>DN-JKIT</u>	Cutting tool kit for DN series jumpers. Includes (1) DN-JXCUT cutting tool, (5) dies (DN-J2DIE, DN-J4DIE, DN-J6DIE, DN-JL14DIE, and DN-JFEDIE).	1	
<u>DN-TOOL2</u>	DINnector tool kit, for use with DN series terminal blocks, includes (1) spring opening tool for DN-Q series screwless terminal blocks and (1) jumper removal tool for J2, J4, J6, and JL14 jumpers.	1	



DN-J2CUT



DN-J4CUT



DN-JKIT



DN-TOOL2

Replacement Dies			
Part Number	Description	Qty	Price
<u>DN-J2DIE</u>	Replacement dies for DN-J2CUT.	2	
<u>DN-J4DIE</u>	Replacement dies for DN-J4CUT.	2	
<u>DN-JFEDIE</u>	Replacement dies for DN-JFECUT.	2	
<u>DN-J6DIE</u>	Replacement dies for DN-J6CUT.	2	
<u>DN-JL14DIE</u>	Replacement dies for DN-JL14CUT.	2	

Note: Replacement Dies also work with DN-JxCUT.

Terminal Blocks

tTBL-83

Terminal Plugs



DN-xxPLUG / DN-xxPLUGMN

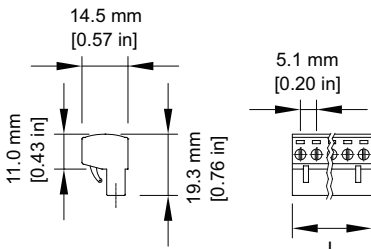

Accessories – Terminal Plugs							
Plugs* Part Number	Qty	Price	Plugs* Part Number	Qty	Price	Number of Poles	Length mm [in]
DN-2PLUG	200		DN-2PLUGMN	10		2	10.2 [0.40]
DN-3PLUG	200		DN-3PLUGMN	10		3	15.2 [0.60]
DN-4PLUG	100		DN-4PLUGMN	10		4	20.3 [0.80]
DN-5PLUG	100		DN-5PLUGMN	10		5	25.4 [1.00]
DN-6PLUG	100		DN-6PLUGMN	10		6	30.5 [1.20]
DN-7PLUG	50		DN-7PLUGMN	5		7	35.6 [1.40]
DN-8PLUG	50		DN-8PLUGMN	5		8	40.6 [1.60]
DN-9PLUG	50		DN-9PLUGMN	5		9	45.7 [1.80]
DN-10PLUG	50		DN-10PLUGMN	5		10	50.8 [2.00]
DN-11PLUG	50		DN-11PLUGMN	5		11	55.9 [2.20]
DN-12PLUG	50		DN-12PLUGMN	5		12	61.0 [2.40]
Terminal Plugs Ratings							
Voltage/Current	300V, 12A						
Wire Gauge	14–22 AWG, CU only						
Torque	Tightening Torque: 0.51 N·m [4.5 lb·in]						
Usage Temperature	Ambient air temperature: -20 to 105°C [-4 to 221°F] Relative humidity: 50% max at 40°C [104°F]; 90% max at 20°C [68°F]						
Agency Approvals	UL file #: E179129						

Note: To obtain the most current agency approval information, see the Agency Approval Checklist section on the specific part number's web page.

* DN-xxPLUGs fit all DN-EMXxx & DN-QEMXxx plug-in terminal blocks

Disconnect Blade



DN-DIS-BLADE
DN-DIS-BMN

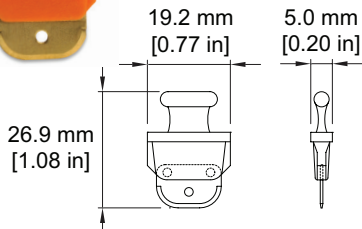

Disconnect Blade			
Part Number	Description	Qty	Price
DN-DIS-BLADE	Terminal block disconnect blade for DN-FE2, DN-FE4, DN-DIS2 and DN-DIS4	50	
DN-DIS-BMN		10	

End Brackets



End Brackets			
Part Number	Description	Qty	Price
DN-EB15	Terminal block end stop 7mm width screw clamping. Gray	100	
DN-EB15MN		20	
DN-EB35	Terminal block end stop 9mm width screw clamping. Gray	50	
DN-EB35MN		20	
DN-EB35-A	Terminal block end stop 6mm width screw clamping. Black	50	
DN-EB35-A-10		10	
DN-QEB35	Terminal block end stop 6mm width screwless clamping. Black	50	
DN-QEB35-10		10	

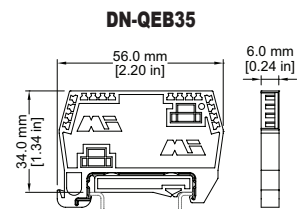
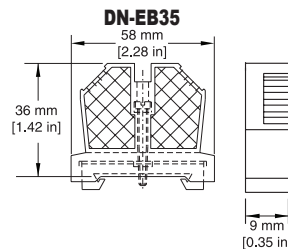
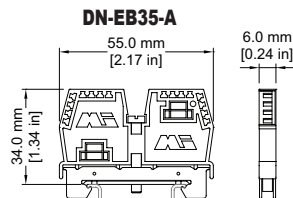
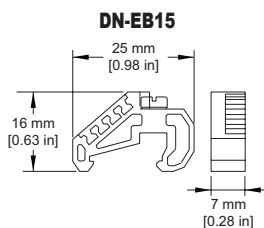

For more information on accessories, see the "DINnectors Accessories" section of this section.

End Covers

Certain end covers can be used with multiple terminal block parts to cover and insulate the open side, or to put more space between adjacent blocks.

DINnectors End Covers				
Part Number	Description	For Use With	Qty	Price
<u>DN-EC1210</u>	Covers open side of DN-T12-A and DN-T10-A series terminal blocks	DN-T10-A, DN-T12-A	100	
<u>DN-EC1210MN</u>			25	
<u>DN-EC86</u>	Covers open side of DN-T8 and DN-T6 series terminal blocks	DN-T8, DN-T6	100	
<u>DN-EC86MN</u>			25	
<u>DN-EC4</u>	Covers open side of DN-T4 series terminal blocks	DN-T4	50	
<u>DN-EC4MN</u>			10	
<u>DN-EC1/0</u>	Covers open side of DN-T1/0 series terminal blocks	DN-T1/0	50	
<u>DN-EC1/0MN</u>			10	
<u>DN-DEC10</u>	Covers open side of DN-D10 series double-level terminal blocks	DN-D10	50	
<u>DN-DEC10MN</u>			10	
<u>DN-EC14</u>	Covers open side of DN-TL14-A series terminal blocks	DN-TL14-A	25	
<u>DN-EC14S</u>	Covers open side of DN-TL14S-A series terminal blocks	DN-TL14S-A	25	
<u>DN-ECM10</u>	Covers open side of DN-M10-A series terminal blocks	DN-M10-A DN-M10B-A	100	
<u>DN-ECM10MN</u>			25	
<u>DN-ECKBD</u>	Covers open side of DN-KBD12 (MN) series disconnect blocks	DN-KBD12 (MN)	100	
<u>DN-ECKBDMN</u>			10	
<u>DN-EMXM1EC1</u>	Covers open side of DN-EMXM1 and DN-QEMXM1 terminal blocks	DN-EMXM1	25	
<u>DN-EMXM1EC2</u>	Covers closed side of DN-EMXM1 and DN-QEMXM1 terminal blocks	DN-QEMXM1	25	
<u>DN-EMXDVEC1</u>	Covers open side of DN-EMXDV and DN-QEMXDV terminal blocks	DN-EMXDV	25	
<u>DN-EMXDVEC2</u>	Covers closed side of DN-EMXDV and DN-QEMXDV terminal blocks	DN-QEMXDV	25	
<u>DN-FESEP</u>	Covers closed side of DN-FE sockets and DN-DIS disconnects	DN-FE, DN-DIS	50	
<u>DN-FESEP-10</u>			10	
<u>DN-QEC12</u>	Covers open side of DN-Q12-A or DN-QG12 series screwless terminal blocks	DN-Q12-A DN-QG12	50	
<u>DN-QEC12MN</u>			10	
<u>DN-QEC10</u>	Covers open side of DN-Q10-A or DN-QG10 series screwless terminal blocks	DN-Q10-A DN-QG10	50	
<u>DN-QEC10MN</u>			10	
<u>DN-QEC8</u>	Covers open side of DN-Q8-A or DN-QG8 series screwless terminal blocks	DN-Q8-A DN-QG8	50	
<u>DN-QEC8MN</u>			10	
<u>DN-QEC12-1-2</u>	Covers open side of DN-Q12-1-2-A and DN-QKBD12-A series screwless terminal blocks	DN-Q12-1-2-A, DN-QKBD12	25	
<u>DN-QEC12-2-2</u>	Covers open side of DN-Q12-2-2-A series screwless terminal blocks	DN-Q12-2-2-A	25	
<u>DN-QDEC12</u>	Covers open side of DN-QD12-A series screwless terminal blocks	DN-QD12-A	25	

Spacers

Spacers are used to put more space between adjacent blocks.

DINnectors Spacers				
Part Number	Description	For Use With	Qty	Price
<u>DN-S1210</u>	Spacer for DN-T12-A and DN-T10-A series terminal blocks	DN-T10-A DN-T12-A	100	
<u>DN-S1210MN</u>			25	
<u>DN-S86</u>	Spacer for DN-T8 and DN-T6 series terminal blocks	DN-T8 DN-T6	100	
<u>DN-S86MN</u>			25	
<u>DN-EMXM1SPA1</u>	Spacer for single-level plug-in terminal blocks	DN-EMXM1 DN-QEMXM1	25	
<u>DN-EMXDVSPA1</u>	Spacer for double-level plug-in terminal blocks	DN-EMXDV DN-QEMXDV	25	
<u>DN-FESPA</u>	Spacer for DN-FE sockets and DN-DIS disconnects	DN-FE DN-DIS	50	
<u>DN-FESPA-10</u>			10	

Top Covers

DINnectors Top Covers				
Part Number	Description	For Use With	Qty	Price
<u>DN-C12</u>	Top cover, clear, printed electrical symbol.	DN-T12-A	100	
<u>DN-C12MN</u>			25	
<u>DN-C10</u>	Top cover, clear, printed electrical symbol.	DN-T10-A	100	
<u>DN-C10MN</u>			25	
<u>DN-C86</u>	Top cover, clear, printed electrical symbol.	DN-T8 DN-T6	100	
<u>DN-C86MN</u>			25	
<u>DN-DC10</u>	Top cover, clear, printed electrical symbol.	DN-D10	100	
<u>DN-DC10MN</u>			25	
<u>DN-MC10</u>	Top cover, clear, printed electrical symbol.	DN-M10	100	
<u>DN-MC10MN</u>			25	

DINnector End Covers and Spacers Dimensions				
Part Number		Length mm[in]	Height mm [in]	Thickness mm [in]
<u>DN-EC1210</u>	<u>DN-EC1210MN</u>	44 [1.73]	35 [1.38]	1.5 [0.06]
<u>DN-S1210</u>	<u>DN-S1210MN</u>	55 [2.17]	44 [1.73]	
<u>DN-EC86</u>	<u>DN-EC86MN</u>	50 [1.97]	43 [1.69]	
<u>DN-S86</u>	<u>DN-S86MN</u>	55 [2.17]	49 [1.93]	
<u>DN-EC4</u>	<u>DN-EC4MN</u>	56 [2.21]	48 [1.89]	
<u>DN-EC1/0</u>	<u>DN-EC1/0MN</u>	62 [2.44]	60 [2.36]	
<u>DN-DEC10</u>	<u>DN-DEC10MN</u>	72 [2.80]	49 [1.93]	
<u>DN-EC14</u>	-	78 [3.08]	55 [2.17]	
<u>DN-EC14S</u>	-	55 [2.17]	50 [1.97]	
<u>DN-ECM10</u>	<u>DN-ECM10MN</u>	32 [1.26]	27 [1.06]	
<u>DN-ECKBD</u>	<u>DN-ECKBDMN</u>	52 [2.05]	34.5 [1.36]	
<u>DN-EMXM1EC1</u>	<u>DN-EMXM1EC2</u>	as shown on next page		
<u>DN-EMXDVEC1</u>	<u>DN-EMXDVEC2</u>			
<u>DN-EMXDVSPA1</u>	<u>DN-EMXM1SPA1</u>			
<u>DN-FESPA</u>	<u>DN-FESPA-10</u>			
<u>DN-FESEP</u>	<u>DN-FESEP-10</u>			
<u>DN-QEC12</u>	<u>DN-QEC12MN</u>	50 [1.97]	23 [0.9]	
<u>DN-QEC10</u>	<u>DN-QEC10MN</u>	57.4 [2.26]	33.6 [1.32]	
<u>DN-QEC8</u>	<u>DN-QEC8MN</u>	63 [2.48]	38.5 [1.52]	
<u>DN-QEC12-1-2</u>	-	68.5 [2.70]	28.5 [1.12]	
<u>DN-QEC12-2-2</u>	-	87.5 [3.44]	28.5 [1.12]	
<u>DN-QDEC12</u>	-	98 [3.86]	37 [1.46]	

DN-EC1210, DN-EC1210MN DN-EC86, DN-EC86MN DN-EC4 (MN), DN-EC1/0 (MN), DN-ECKBD (MN), DN-S1210, DN-S1210MN, DN-S86 (MN)

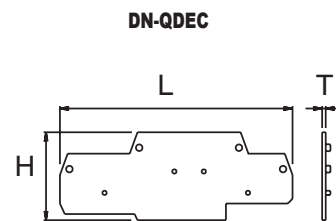
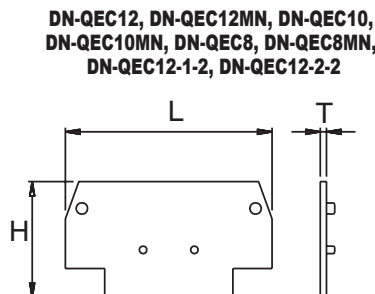
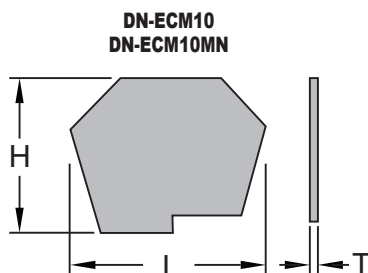
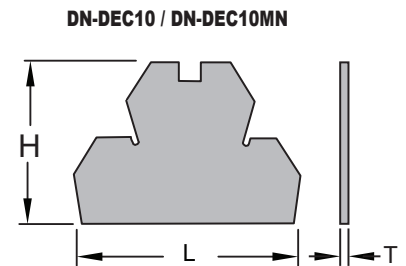
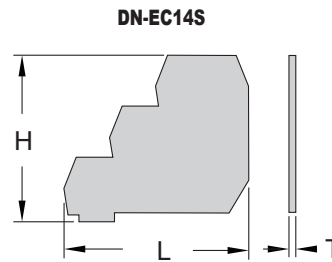
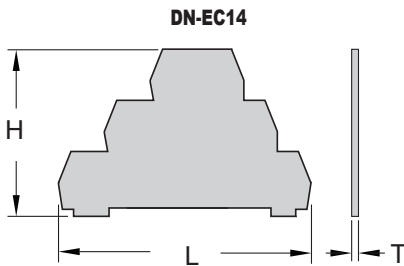
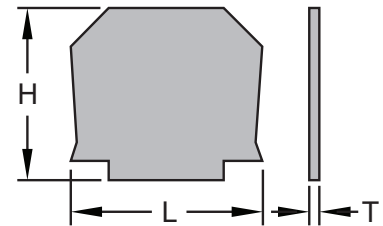

Dimensional Drawings

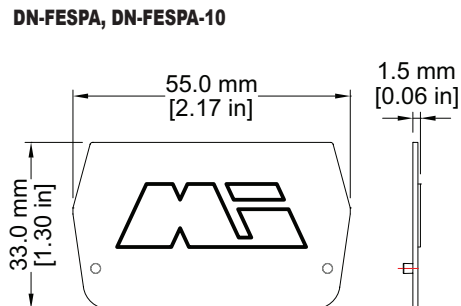
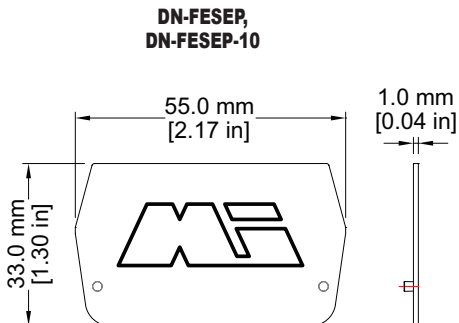
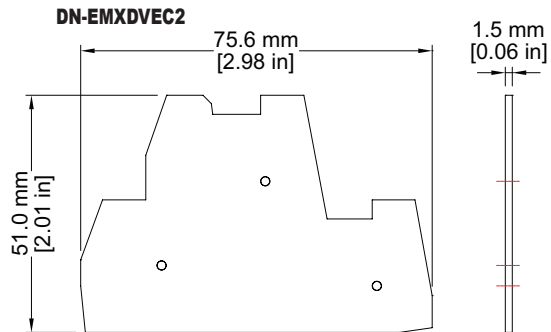
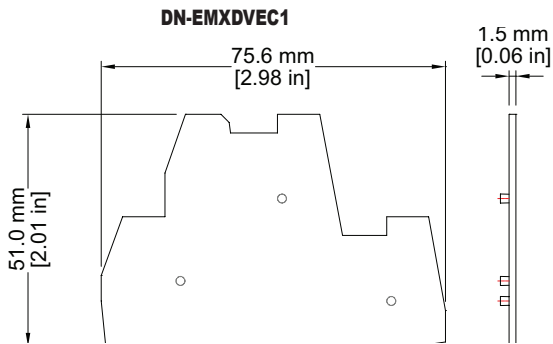
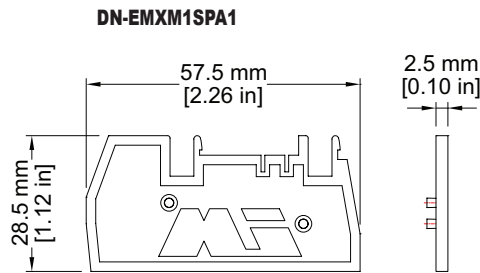
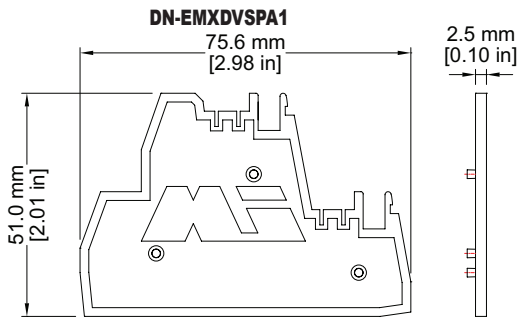
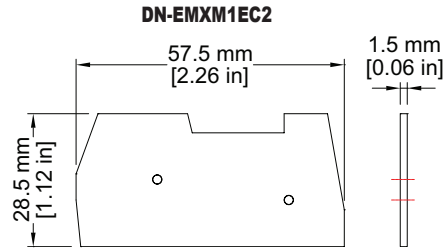
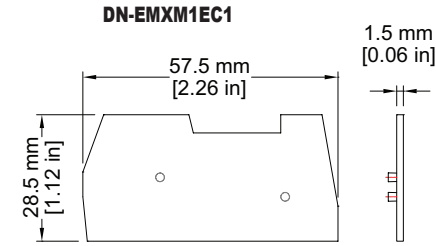

Marking Tags Cross Reference Charts - Screwless

DINnector Marking Tags Cross Reference - Screwless				
<i>Block Type</i>	<i>DN-QL</i>	<i>DN-LA</i>	<i>DN-LT</i>	<i>DN-EMLBL</i>
<u><i>DN-Q12</i></u>	X	-	-	-
<u><i>DN-Q10</i></u>	X	-	-	-
<u><i>DN-Q8</i></u>	X	-	-	-
<u><i>DN-QD12</i></u>	X	-	-	-
<u><i>DN-Q12-1-2</i></u>	X	-	-	-
<u><i>DN-Q12-1-2L</i></u>	X	-	-	-
<u><i>DN-Q12-1-2D</i></u>	X	-	-	-
<u><i>DN-QKBD</i></u>	X	-	-	-
<u><i>DN-Q12-2-2</i></u>	X	-	-	-
<u><i>DN-Q12-2-2L</i></u>	X	-	-	-
<u><i>DN-Q12-2-2D</i></u>	X	-	-	-
<u><i>DN-QEMXM1</i></u>	-	X	X	X
<u><i>DN-QEMXDV</i></u>	-	X	X	X
<u><i>DN-QG12</i></u>	X	-	-	-
<u><i>DN-QG10</i></u>	X	-	-	-
<u><i>DN-QG8</i></u>	X	-	-	-
<u><i>DN-QG12-1-2</i></u>	X	-	-	-
<u><i>DN-QG12-2-2</i></u>	X	-	-	-

Marking Tags

Marking Tags DN-L Series			
Part Number	Marking Sequence	Qty	Price
<u>DN-L50</u>	1-50	500	
<u>DN-L100</u>	51-100	500	
<u>DN-L150</u>	101-150	500	
<u>DN-L200</u>	151-200	500	
<u>DN-L250</u>	201-250	500	
<u>DN-L300</u>	251-300	500	
<u>DN-L350</u>	301-350	500	
<u>DN-L400</u>	351-400	500	
<u>DN-L450</u>	401-450	500	
<u>DN-LB</u>	Blank	500	
<u>DN-LS</u>	L1, L2, L3, L, N, GND, +, -, COM, COM*	500	

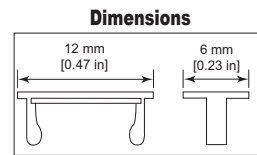

- The marking sequence of 50 tags (i.e. 101-150) is printed 10 times in each package of 500.
- The DN-L tags fit all DINnectors 6mm wide and wider.
- There will be a gap between tags on blocks wider than 6mm.
- Material: Thermoplastic with heat embossed black print.

Marking Tags DN-LA Series			
Part Number	Marking Sequence	Qty	Price
<u>DN-LA100</u>	1-100	500	
<u>DN-LA200</u>	101-200	500	
<u>DN-LA300</u>	201-300	500	
<u>DN-LA400</u>	301-400	500	
<u>DN-LAB</u>	Blank Tags	500	
<u>DN-LAS</u>	L1, L2, L3, L, N, GND, +, -, COM, COM*	500	

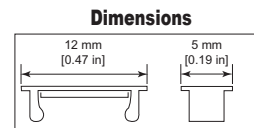

- The marking sequence of 100 tags (i.e. 1-100) is printed five times in each package of 500.
- The DN-LA tags fit all DINnectors 5mm wide and wider. There will be a gap between tags on blocks wider than 5mm.
- Material: Thermoplastic with heat embossed black print.

Marking Tags DN-LAT Series			
Part Number	Marking Sequence	Qty	Price
<u>DN-LAT100-A</u>	1-100	500	
<u>DN-LAT200-A</u>	101-200	500	
<u>DN-LAT300-A</u>	201-300	500	
<u>DN-LAT400-A</u>	301-400	500	
<u>DN-LAT500-A</u>	401-500	500	
<u>DN-LAT600-A</u>	501-600	500	
<u>DN-LATB-A</u>	Blank Tags	500	
<u>DN-LATS-A</u>	L1, L2, L3, L, N, +, -, COM, COM*	500	

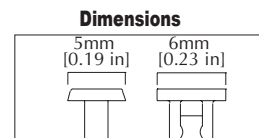

- The marking sequence of 500 tags (i.e. 1-100) is printed five times in each package of 500.
- Material: Thermoplastic with heat embossed black print.

Marking Tags DN-QL Series			
Part Number	Marking Sequence	Qty	Price
<u>DN-QL100</u>	1-100	500	
<u>DN-QL200</u>	101-200	500	
<u>DN-QL300</u>	201-300	500	
<u>DN-QL400</u>	301-400	500	
<u>DN-QL500</u>	401-500	500	
<u>DN-QLB</u>	Blank Tags	500	
<u>DN-QLS</u>	L1, L2, L3, L, N, +, -, COM, COM*	500	

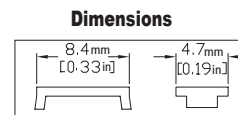

- The marking sequence of 500 (i.e. 1-100) is printed five times in each package of 500.
- Material: Thermoplastic with heat embossed black print.

Marking Tags continued

Marking Tags DN-LT Series			
Part Number	Marking Sequence	Qty	Price
DN-LT15	1-5	100	
DN-LT60	6-0	100	
DN-LT1	1	100	
DN-LT2	2	100	
DN-LT3	3	100	
DN-LT4	4	100	
DN-LT5	5	100	
DN-LT6	6	100	
DN-LT7	7	100	
DN-LT8	8	100	
DN-LT9	9	100	
DN-LT0	0	100	
DN-LTBLNK	Unprinted	100	
DN-LTA	A	100	
DN-LTB	B	100	
DN-LTC	C	100	
DN-LTD	D	100	
DN-LTE	E	100	
DN-LTF	F	100	
DN-LTG	G	100	
DN-LTH	H	100	
DN-LTI	I	100	
DN-LTJ	J	100	
DN-LTK	K	100	
DN-LTL	L	100	
DN-LTM	M	100	
DN-LTN	N	100	
-	-	-	-
DN-LTP	P	100	
DN-LTQ	Q	100	
DN-LTR	R	100	
DN-LTS	S	100	
DN-LTT	T	100	
DN-LTU	U	100	
DN-LTV	V	100	
DN-LTW	W	100	
DN-LTX	X	100	
DN-LTY	Y	100	
DN-LTZ	Z	100	
DN-LTGND	⊕	100	
DN-LTPOS	+	100	
DN-LTNEG	-	100	
DN-LTAC	~	100	
DN-LTDC	=	100	

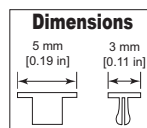

- These marking tags allow the flexibility of creating custom marking sequences on site.
- The DN-M series supports a maximum of three digits (tags), while other DINnectors support up to four digits (tags).
- Material: Thermoplastic with heat embossed black print.

DN-MTA marking tag adapter

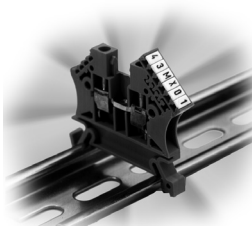

DN-MTA dimensions

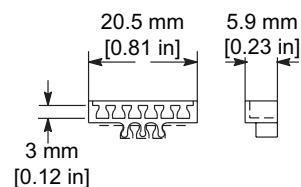

Part Number	Description	Qty	Price
DN-MTA	Marking tag adapter holds up to six DN-LT tags	50	

Note: DN-MTA adapter does not fit DN-T12-A terminal blocks.

Terminal Marking Accessories



DN-EMLBL1



DN-EMLBL2



DN-EMLBL3

Part Number	Description	For Use With	Qty	Price
DN-EMLBL1	Blank labels	DN-EMPEG1 pin protectors for DN-xEMXxx plug-in terminal blocks	100	
DN-EMLBL2	Labels printed 1 – 12		100	
DN-EMLBL3	Labels printed 13 – 24		100	

Marking Pen – for terminal and wire marking tags

- Permanent
- Smudge-proof
- Waterproof
- Weatherproof
- Lightfast (won't fade)
- Dries in seconds (excellent for left-handed users)
- Dry-safe (pen can be left uncapped for days without drying out)
- Low odor ink

Part Number	Description	Qty	Price
DN-MP	Indelible black ink marking pen	1	



Marking pen

Wire Marking Accessories



DN-WMTAG1 wire tags & DN-WM-x wire tag holders

Part Number	Description	For Use With	Qty	Price
DN-WMTAG1	Wire tag – blank	all DN-WM-x wire tag holders	525	
DN-WM-1	Wire tag holder, clear, 12mm length, 0.051–0.118 in diameter; for 22–16 AWG wire	DN-WMTAG1	200	
DN-WM-2	Wire tag holder, clear, 12mm length, 0.098–0.196 in diameter; for 16–11 AWG wire		200	
DN-WM-3	Wire tag holder, clear, 12mm length, 0.157–0.393 in diameter; for 13–5 AWG wire		100	
DN-WM-4	Wire tag holder, clear, 12mm length, 0.314–0.629 in diameter; for 5AWG wire		100	

Screwless DINnectors Cross Reference

Allen-Bradley Part Number	Screwless DINnectors Part Number
1492-R4	DN-Q10-A
1492-R4-B	DN-Q10B-A
1492-R3	DN-Q12-A
1492-R3T	DN-Q12-1-2-A
1492-R3Q	DN-Q12-2-2-A
1492-R3-B	DN-Q12B-A
1492-R3T-B	DN-Q12B-1-2-A
1492-R3Q-B	DN-Q12B-2-2-A
1492-R6	DN-Q8-A
1492-R6-B	DN-Q8B-A
1492-RD3	DN-QD12-A
1492-RD3-B	DN-QD12B-A
1492-RD3C	DN-QD12X-A
1492-TC4	DN-QEC10
1492-RG4	DN-QG10
1492-RG3	DN-QG12
1492-RG6	DN-QG8
1492-SM5x9	DN-QL100
1492-SM5x9	DN-QLB
1492-RG3T	DN-QG12-1-2
1492-RG3Q	DN-QG12-2-2
1492-RKD3	DN-QKBD12-A

Phoenix Part Number	Screwless DINnectors Part Number
3031364	DN-Q10-A
3031377	DN-Q10B-A
3031212	DN-Q12-A
3031241	DN-Q12-1-2-A
3031306	DN-Q12-2-2-A
3031225	DN-Q12B-A
3031254	DN-Q12B-1-2-A
3031319	DN-Q12B-2-2-A
3031487	DN-Q8-A
3031490	DN-Q8B-A
3031270	DN-QD12-A
3031283	DN-QD12B-A
3031539	DN-QD12X-A
3030420	DN-QEC10
3031380	DN-QG10
3031238	DN-QG12
3031500	DN-QG8
1050211	DN-QL100
1050004	DN-QLB
3104013	DN-QG12-1-2
3031267	DN-QG12-2-2
3031322	DN-QKBD12-A

Wago Part Number	Screwless DINnectors Part Number
282-901	DN-Q10-A
282-904	DN-Q10B-A
280-901	DN-Q12-A
280-681	DN-Q12-1-2-A
280-833	DN-Q12-2-2-A
280-904	DN-Q12B-A
280-684	DN-Q12B-1-2-A
280-834	DN-Q12B-2-2-A
284-601	DN-Q8-A
284-604	DN-Q8B-A
281-619	DN-QD12-A
281-629	DN-QD12B-A
N/A	DN-QD12X-A
282-325	DN-QEC10
282-907	DN-QG10
281-907	DN-QG12
284-907	DN-QG8
N/A	DN-QL100
209-xxx	DN-QLB
279-687	DN-QG12-1-2
279-837	DN-QG12-2-2
280-870	DN-QKBD12-A

Weidmuller Part Number	Screwless DINnectors Part Number
163205	DN-Q10-A
163206	DN-Q10B-A
160851	DN-Q12-A
160854	DN-Q12-1-2-A
160857	DN-Q12-2-2-A
160852	DN-Q12B-A
160855	DN-Q12B-1-2-A
160858	DN-Q12B-2-2-A
160862	DN-Q8-A
160863	DN-Q8B-A
167430	DN-QD12-A
167863	DN-QD12B-A
168999	DN-QD12X-A
163209	DN-QEC10
163208	DN-QG10
160864	DN-QG12
160867	DN-QG8
161000	DN-QL100
161000	DN-QLB
160865	DN-QG12-1-2
160866	DN-QG12-2-2
160868	DN-QKBD12-A