

SOLO Standard Temperature Controllers - 1/8 DIN

SL4896 Series

Features

- 1/8 DIN panel size
- PID with Autotune
- Thermocouple, RTD, mA, mV and voltage inputs
- 2 event inputs
- Output #1: Relay, Voltage Pulse, Current or Linear Voltage
- Output #2: Relay or Alarm Relay
- RS-485 communications port
- UL, CUL and CE approvals



Scan or click the above QR code to be taken to the SL4896 Series Quick Start Guide



Scan or click the above QR code to be taken to the SOLO Standard Series Manual

Note: A set of mounting clips and a 249 Ω resistor are included.
Extra mounting clips are available (Part Number: SL-CLP-2, Qty: 20 per package)

Output Specifications						
Part Number	Price	Input Voltage	Output #1	Output #2 / Alarm #3*	Alarm #1	Alarm #2
SL4896-RRE		110 - 240 VAC	Relay - SPDT	Relay - SPDT	Relay - SPST	Relay - SPST
SL4896-VRE		110 - 240 VAC	Voltage Pulse	Relay - SPDT	Relay - SPST	Relay - SPST
SL4896-CRE		110 - 240 VAC	Current	Relay - SPDT	Relay - SPST	Relay - SPST
SL4896-LRE		110 - 240 VAC	Linear Voltage	Relay - SPDT	Relay - SPST	Relay - SPST
SL4896-RRE-D		24 VDC	Relay - SPDT	Relay - SPDT	Relay - SPST	Relay - SPST

Note: Inputs are sinking, outputs are sourcing.
*Output #2 can be configured as control output #2 or as Alarm #3

Dimensions

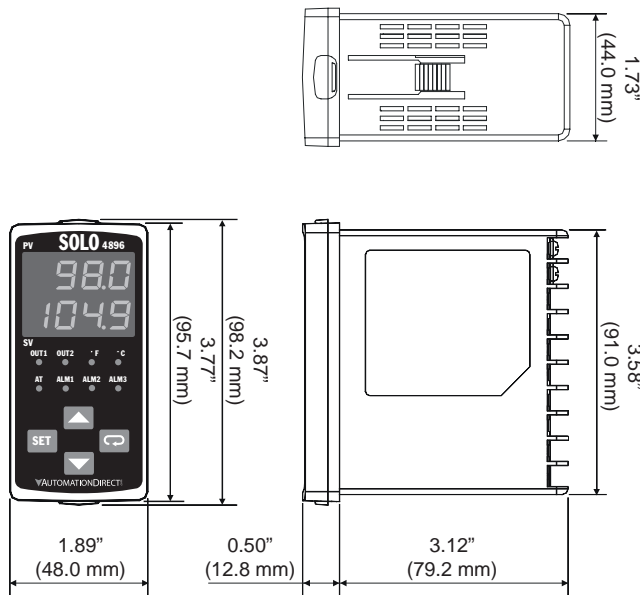

See our website for complete Engineering drawings.

Minimum Cutout and Spacing

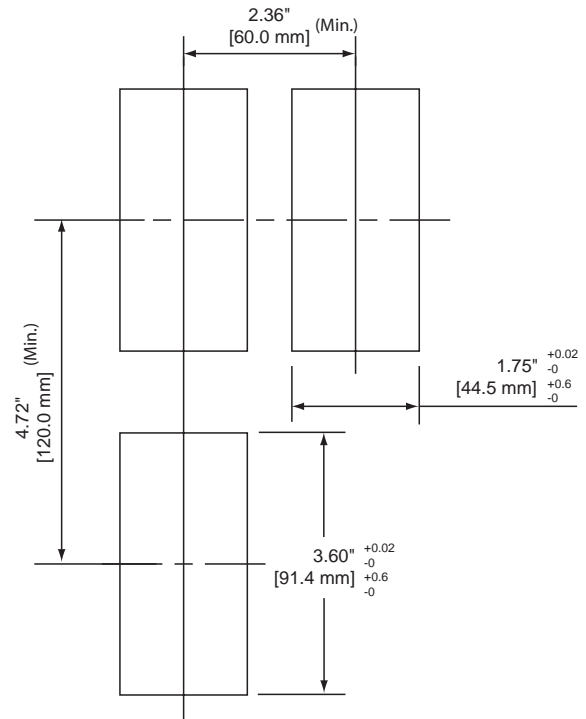

SOLO Standard Temperature Controllers

Overview

AutomationDirect's SOLO series includes single-loop dual-output temperature controllers that can control both heating and cooling simultaneously. There are four types of control modes: PID, ON/OFF, Ramp/Soak and Manual. Depending upon the model of controller, the available outputs include relay, voltage pulse, current, and linear voltage. There are up to three alarm outputs available. (The SL4824 series supports only one alarm output.) Select from seventeen alarm types in the initial setting mode. SOLO controllers can accept various types of thermocouple, RTD, or analog inputs. SOLO controllers have a built-in RS-485 interface using Modbus slave (ASCII or RTU) communication protocol.

Features



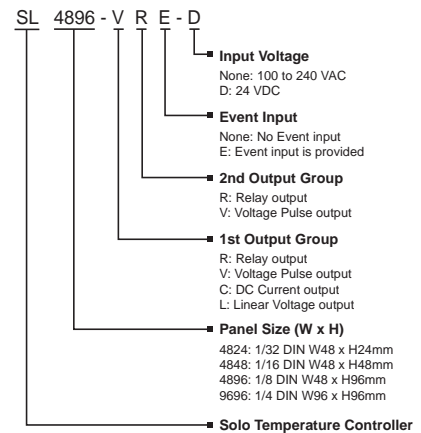

- 1/32 DIN, 1/16 DIN, 1/8 DIN, or 1/4 DIN panel size
- 2 line x 4 character 7-segment LED display for Process value (PV): Red color, and Set Point (SV): Green color
- PID control with Autotune (AT) function
- Accepts eleven types of thermocouples, two types of Pt100 RTD temperature sensors, and DC mA, mV, and Volt signals
- Selectable between °F and °C for thermocouple or RTD inputs.
- 0°C to 50 °C operating temperature range
- Up to three alarm groups, each with seventeen available alarm types.
- Four possible control output options depending on model; Relay, Voltage Pulse, Current, and Linear Voltage.
- Baud rates up to 38.4K bps.
- Thermocouple and Platinum RTD sample rates at 400 ms per scan
- Analog sample rate at 150 ms per scan
- 64 levels of Ramp / Soak control
- Two optional Event Inputs available in 1/8 DIN and 1/4 DIN sizes
- UL, CUL, and CE agency approvals

SOLO Controller Part Number Key



Specifications	
Input Power Requirements	100 to 240 VAC 50 / 60 Hz or 24 VDC
Operation Voltage Range	AC: 85 VAC to 264 VAC or DC: 21.6 VDC to 26.4 VDC
Power Consumption	5 VA Max
Memory Protection	EEPROM 4K bit, number of writes 100,000
Control Mode	PID, ON/OFF, Ramp / Soak control or Manual
Input Accuracy	Less than ± 0.2% full scale (except thermocouple R, S, & B types) Max ± 3° (thermocouple R, S, & B types)
Vibration Resistance	10 to 55 Hz, 10 m/s ² for 10 min, each in X, Y and Z directions
Shock Resistance	Max. 300 m/s ² , 3 times in each 3 axes, 6 directions
Ambient Temperature Range	32°F to 122°F (0°C to 50°C)
Storage Temperature Range	-4°F to 149°F (-20°C to 65°C)
Altitude	2000m or less
Relative Humidity	35% to 80% (non-condensing)
RS-485 Communication	Modbus slave ASCII / RTU protocol
Transmission Speed	2400, 4800, 9600, 19.2K, 38.4K bps
IP Rating	IP65: Complete protection against dust and low pressure spraying water from all directions. (inside suitable enclosure)
Agency Approvals	UL, CUL, CE (UL file number E311366)
Pollution Degree	Degree 2 - Normally, only non-conductive pollution occurs. Temporary conductivity caused by condensation is to be expected
Input Types	
• Thermocouple*	K, J, T, E, N, R, S, B, L, U, TXK (400 ms per scan)
• Platinum RTD	3-wire Pt100, JPt100 (400 ms per scan)
• Analog	0-50 mV, 0-5V, 0-10V, 0-20 mA, 4-20 mA (sinking) (150 ms per scan)**
Control Output Options	
• Relay (R)	SL4824: SPST max. resistive load 3A @ 250 VAC SL4848: SPST max. resistive load 5A @ 250 VAC SL4896, SL9696: SPDT max. resistive load 5A @ 250 VAC SL4824: SPST max. resistive load 3A @ 30 VDC SL4848: SPST max. resistive load 5A @ 30 VDC SL4896, SL9696: SPDT max. resistive load 5A @ 30 VDC
• Voltage Pulse (V)	DC 14V Max, output current 40mA Max
• Current (C)	DC 4-20 mA output (sourcing) (Load resistance: Max 600Ω)
• Linear Voltage (L)	DC 0-10V (Load resistance Min 1KΩ)
*Note: Use only ungrounded thermocouples. ** Analog input impedance: 1.8MΩ	

SOLO Standard Temperature Controller Selection Guide

SOLO Standard Temperature Controller Selection Guide											
Series		Part Number	Price	Dimensions	Display	Input Voltage	Control Output 1	Control Output 2	Event Inputs	Alarm Outputs	RS-485 Port
SL4824		SL4824-RR		W - 48mm H - 24mm D - 103mm (1/32 DIN)	Two 4-digit PV: 7mm red SV: 6mm green	100 - 240 VAC	Relay - 3A, SPST	Relay - 3A, SPST		Control Output 2 can be used as Alarm 1	
		SL4824-VR				100 - 240 VAC	Voltage Pulse				
		SL4824-CR				100 - 240 VAC	Current				
		SL4824-LR				100 - 240 VAC	Linear Voltage				
		SL4824-RR-D				24 VDC	Relay - 3A, SPST				
		SL4824-VR-D				24 VDC	Voltage Pulse				
		SL4824-CR-D				24 VDC	Current				
SL4848		SL4848-RR		W - 48mm H - 48mm D - 90mm (1/16 DIN)	Two 4-digit PV: 7mm red SV: 7mm green	100 - 240 VAC	Relay - 5A, SPST	Relay - 5A, SPST	N/A	Alarm 1 and Alarm 2 are 3A, SPST Relays with a shared common. Control Output 2 can be used as Alarm 3	
		SL4848-VR				100 - 240 VAC	Voltage Pulse				
		SL4848-CR				100 - 240 VAC	Current				
		SL4848-LR				100 - 240 VAC	Linear Voltage				
		SL4848-RR-D				24 VDC	Relay - 5A, SPST				
		SL4848-VR-D				24 VDC	Voltage Pulse				
		SL4848-CR-D				24 VDC	Current				
		SL4848-VV				100 - 240 VAC	Voltage Pulse	Voltage Pulse		Alarm 1 and Alarm 2 are 3A, SPST Relays with a shared common.	
		SL4848-CV				100 - 240 VAC	Current				
SL4848-LV		100 - 240 VAC	Linear Voltage								
SL4896		SL4896-RRE		W - 48mm H - 96mm D - 92mm (1/8 DIN)	Two 4-digit PV: 10mm red SV: 10mm green	100 - 240 VAC	Relay - 5A, SPDT	Relay - 5A, SPDT		Alarm 1 and Alarm 2 are 3A, SPST Relays. Control Output 2 can be used as Alarm 3	
		SL4896-VRE				100 - 240 VAC	Voltage Pulse				
		SL4896-CRE				100 - 240 VAC	Current				
		SL4896-LRE				100 - 240 VAC	Linear Voltage				
		SL4896-RRE-D				24 VDC	Relay - 5A, SPDT				
SL9696		SL9696-RRE		W - 96mm H - 96mm D - 95mm (1/4 DIN)	Two 4-digit PV: 20mm red SV: 13mm green	100 - 240 VAC	Relay - 5A, SPDT	Relay - 5A, SPDT	Event 1 / Event 2	Alarm 1 and Alarm 2 are 3A, SPST Relays. Control Output 2 can be used as Alarm 3	
		SL9696-VRE				100 - 240 VAC	Voltage Pulse				
		SL9696-CRE				100 - 240 VAC	Current				
		SL9696-LRE				100 - 240 VAC	Linear Voltage				
		SL9696-RRE-D				24 VDC	Relay - 5A, SPDT				
		SL9696-VVE				100 - 240 VAC	Voltage Pulse	Voltage Pulse		Alarm 1 and Alarm 2 are 3A, SPST Relays	
		SL9696-CVE				100 - 240 VAC	Current				
SL9696-LVE		100 - 240 VAC	Linear Voltage								

***Notes: EVENT1 input is a normally open contact input that controls the output(s) of the controller. All controller outputs are disabled when the contact is closed. EVENT2 input is a normally open contact input that switches the control parameter group between two control parameter groups based on the state of EVENT2. If the contact is open, the primary control parameter group is used for all parameters and outputs. If the contact is closed, the secondary control parameter group is used for all parameters and outputs. Each temperature setting value has individual control parameters.**



Click on the above thumbnail or go to <https://VID-PS-0002> for a short introductory video on the SOLO Temperature Controllers.

SOLO Standard Temperature Controller Selection Guide, continued

Available Input Types

All SOLO temperature controllers support these input types.

Thermocouple Type and Range*	
Input Temperature Sensor Type	Temperature Range
<i>Thermocouple TXK type</i>	-328 to 1472°F (-200 to 800°C)
<i>Thermocouple U type</i>	-328 to 932°F (-200 to 500°C)
<i>Thermocouple L type</i>	-328 to 1562°F (-200 to 850°C)
<i>Thermocouple B type</i>	212 to 3272°F (100 to 1800°C)
<i>Thermocouple S type</i>	32 to 3092°F (0 to 1700°C)
<i>Thermocouple R type</i>	32 to 3092°F (0 to 1700°C)
<i>Thermocouple N type</i>	-328 to 2372°F (-200 to 1300°C)
<i>Thermocouple E type</i>	32 to 1112°F (0 to 600°C)
<i>Thermocouple T type</i>	-328 to 752°F (-200 to 400°C)
<i>Thermocouple J type</i>	-148 to 2192°F (-100 to 1200°C)
<i>Thermocouple K type</i>	-328 to 2372°F (-200 to 1300°C)

**Note: Use only ungrounded thermocouples.*

RTD Type and Range	
Input Temperature Sensor Type	Temperature Range
<i>Platinum Resistance (Pt100)</i>	-328 to 1112°F (-200 to 600°C)
<i>Platinum Resistance (JPt100)</i>	-4 to 752°F (-20 to 400°C)

Voltage Input Type and Input Range	
Voltage Input Type	Engineering Range
<i>0~50mV Analog Input</i>	-999 to 9999
<i>0V~10V Analog Input</i>	-999 to 9999
<i>0V~5V Analog Input</i>	-999 to 9999

Current Input Type and Range	
Current Input Type	Engineering Range
<i>4~20mA Analog Input</i>	-999 to 9999
<i>0~20mA Analog Input</i>	-999 to 9999

User Configurable Output Options	
Control Output 1	Control Output 2
Heating	(Alarm 1)
Cooling	(Alarm 1)
Heating	Cooling
Cooling	Heating

Mounting Clips			
Series	Part Number	Pkg. Qty.	Price
<i>SL4824</i>	SL-CLP-1	8	
<i>SL4848</i>	SL-CLP-2	20	
<i>SL4896</i>			
<i>SL9696</i>			

SOLO Standard Process and Temperature Controllers



Choose from 30 models (starting under \$100)

SOLO® Standard Series Controllers

The powerful SOLO® Standard series of temperature process controllers take a signal from a temperature device, such as a thermocouple or RTD, or from a pressure/ flow/ level sensor, and maintain a setpoint using an output signal (relay, voltage pulse, current, or linear voltage depending on model). SOLO Standard series support four control modes: PID, ON/OFF, Ramp/Soak and Manual.

With the SOLO® Standard series, you get:

- **Precise control**
- **Flexible connectivity**
- **The right size to fit your application**
- **An unbeatable price that includes free award-winning technical support**
- **AC powered or 24VDC models**

Universal inputs

All SOLO Standard series controllers support 13 temperature input types and 5 analog input types, and with a few simple steps from the industry's best installation documentation, and your process will be up and running in no time.



Simple pushbutton navigation programming, or download the FREE software from our Website for programming and monitoring the SOLO controllers.

Select the SOLO® Standard controller that best fits your application

SOLO brand controllers offer you outstanding features at unbeatable prices:

- 4 standard DIN sizes with a dual 4-digit, 7-segment displays for Process Variable and Setpoint
- Dual output control for heating and cooling
- Built-in PID with Autotuning (AT) function for fast and easy startups
- Universal inputs, including T/C, RTD, and DC voltage, are standard on all controllers, mA and mV are standard on all SL models
- Flexible control modes to fit your process include PID, On/Off and Manual for all controllers and Ramp/Soak for SL models
- IP65 environmental rating (when mounted in appropriate enclosures)

	1/32 DIN SL4824	1/16 DIN SL4848	1/8 DIN SL4896	1/4 DIN SL9696
Features				
Display of PV & SP	Yes	Yes	Yes	Yes
RS-485, MODBUS RTU/ASCII	Yes	Yes	Yes	Yes
Two Separate Event Inputs	No	No	Yes	Yes
Dual Outputs for Heating & Cooling Loops	Yes	Yes	Yes	Yes
Available Alarms Groups	1	3	3	3
Auto Tuning Capability	Yes	Yes	Yes	Yes
Universal Inputs (T/C, RTD, mV & mA)	Yes	Yes	Yes	Yes
	go to page P5-10	go to page P5-11	go to page P5-12	go to page P5-13

Simple Configuration and Control

FREE configuration and monitoring software

That's right, FREE! Configuration and monitoring software (SL-SOFT, Version 2.0 downloadable from our Web site) allows you to configure each controller with ease and gives you data analysis capabilities for up to 16 units simultaneously.

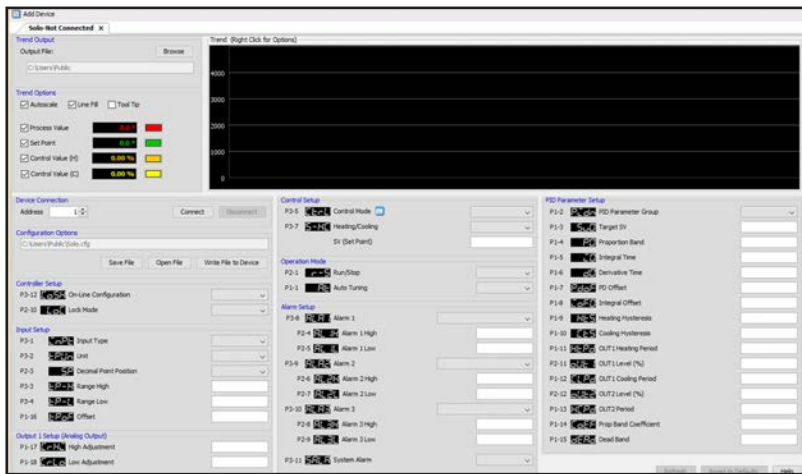

Process control setup made easy

All units support RS-485 serial communications (up to 38.4K bps), which allows you to use the free configuration software [SL-SOFT] to configure and monitor multiple SOLO controllers using Modbus RTU or Modbus ASCII protocols. For even simpler setup, the controller can be configured manually with the user-friendly keypad on each unit.

Collect and act on data

Using RS-485 communications, the SL-SOFT utility provides the ability to monitor and log historical data, using the built-in trending graph, from up to 16 devices and save it to a file.

FREE software that's easy-to-use and intuitive, with a GUI that makes setting up the SOLO series of temperature controllers a breeze.
(Download at <http://support.automationdirect.com/downloads.html>)

Connect to other hardware

The RS-485 communications of the SOLO Temperature Controller can also provide connection to any HMI, PC or PLC supporting industry-standard Modbus RTU or Modbus ASCII protocol. This allows you to collect, monitor and have your application react to data being read from the SOLO controllers.

PLC Connection

Use a PLC to collect data from the controllers and then have your program trigger events based on the values



HMI Connection

Use an operator interface to collect data and monitor your process.



PC Connection

Use a PC to configure and monitor your SOLO controllers with SL-SOFT. Use the trending graph to monitor and log historical data.



Dynamically View and Archive Process Data



Global graph

Capture historical temperature data to your PC for trending and more. SL-SOFT V2.0 allows display of trend graphs from live and saved data, so you can graph process values, set points, and control values (for both heating & cooling).

- Select active pens and pen colors for each trend
- The Autoscale feature fits the vertical scaling (y-axis) to the window.
- Tool Tips allow you to hover over a line on the graph and get details about that value.
- Display data from multiple devices on one chart, if desired.

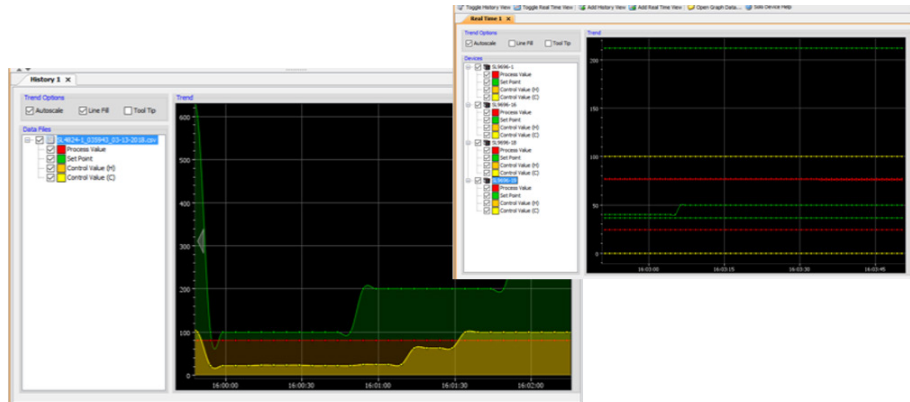

Save and load entire configurations

Use the SL-SOFT V2.0 to save your Solo configuration settings to disk. Then program a new controller with just a few clicks.

All the configuration parameters are available via the software interface and the faceplate of the Solo controller.

Create ramp/soak profiles

Ramp the effective setpoint towards the final target value at a predefined rate with ramp/soak profiles.

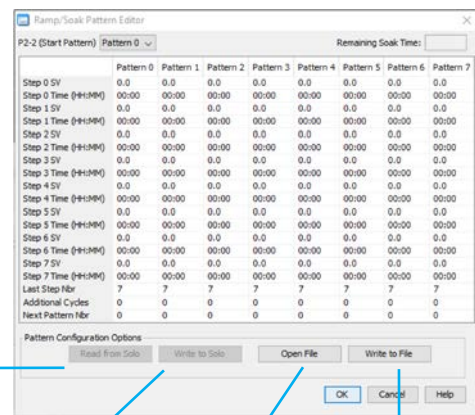

Read the pattern stored in the device

Send current pattern to the device

Open a previously created pattern

Write current pattern to a file to be stored offline

Faceplate view

Display the face plates of multiple connected controllers (up to 16). View the process and setpoint values, output status, alarm indication and more - in real time - right from your desk or other factory PC.

