

PROFIBUS™ Slave

T1H-PBC

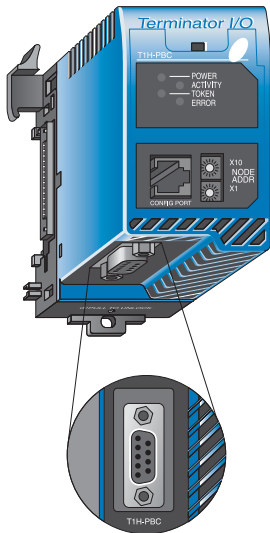

PROFIBUS™ I/O system overview

If you are using a PROFIBUS™ controller network, the Terminator I/O sub-system will help further reduce the cost of your overall application. The T1H-PBC module allows the micro-modular Terminator I/O sub-system to be linked with a PROFIBUS master controller. PROFIBUS is a control bus that provides a common method to connect automation equipment with devices on a single network. This standard communications media is referred to as PROFIBUS and significantly reduces hardwiring costs. PROFIBUS provides specifications for information exchanged between nodes, such as controller data associated with low-level device and configuration parameters individually related to system operations.

PROFIBUS allows 32 stations per segment. Segments vary in length depending on the desired transmission speed. The maximum speed is achieved on a segment 100 meters (327 feet) in length. Our PROFIBUS-DP Slave represents a single station. Repeaters also count as stations and are used to extend the network to greater distances. Our PROFIBUS module supports baud rates of 9.6 Kbaud to 12 Mbaud depending on the network length.

Here's how it works:

The T1H-PBC module is a PROFIBUS slave, which can be plugged into the network interface position of the Terminator I/O micro-modular family of I/O bases. This module reports all the identification data, diagnostic information, and parameters that control the module operation. The T1H-PBC module scans and reports all discrete and analog I/O data to a PROFIBUS master. The externally-powered AC Terminator I/O base units contain a 24 VDC power supply for simple wiring of sensors and actuators into the Terminator I/O modules, and for controlling them with a PROFIBUS master. Using our PROFIBUS I/O sub-system will increase installation flexibility as well as save on wiring costs. The T1H-PBC module supports all Terminator discrete and analog I/O modules.

The T1H-PBC also offers the following features:

- **Cost-effective:** With a single network for devices, hardwiring costs are reduced.
- **Easy connectivity:** Low-cost installation is easy to implement and maintain.
- **Diagnostics:** The PROFIBUS slave offers advanced error diagnostics not commonly available in traditional systems.
- **High baud rates:** Response time is 10 ms per device
- **LED Indicators:** These provide quick indication of Terminator power and operating mode.

Specifications	
Module Type	PROFIBUS Network Interface Module
Max. Expansion	126 stations, 32 stations per segment, 9 repeaters in a row
Max. I/O Points per Controller	244 Input Bytes (analog or discrete) 244 Output Bytes (analog or discrete) as specified by the PROFIBUS DP Specification
Communications	RS-485 PROFIBUS, PROFIBUS-DP. Baud rate selectable from 9.6 Kbaud to 12 Mbaud.
Module Connectors	PROFIBUS 9-pin D-shell, RJ-12 serial (for firmware update only)
Internal Power Consumption	530 mA maximum at 5 VDC (supplied by base power supply)
Operating Environment	0°C to 60°C (32°F to 140°F), 5% to 95% humidity (non-condensing)
Manufacturer	Host Automation Products, L.L.C.



Please Note:

1. Terminator I/O PROFIBUS slave network interface module T1H-PBC is a PTO-certified PROFIBUS-compliant slave I/O interface product. See www.profibus.com for more information.
2. For use with Think & Do Software, we recommend the SST PROFIBUS PCI Master Card, part number 5136-PFB-PCI. (AutomationDirect does not provide this interface). See www.mysst.com for more information.

PROFIBUS Slave

PLC Overview

DL05/06 PLC

DL105 PLC

DL205 PLC

DL305 PLC

DL405 PLC

Field I/O

Software

C-more HMI's

Other HMI

AC Drives

Motors

Steppers/ Servos

Motor Controls

Proximity Sensors

Photo Sensors

Limit Switches

Encoders

Current Sensors

Pushbuttons/ Lights

Process

Relays/ Timers

Comm.

TB's & Wiring

Power

Circuit Protection

Enclosures

Appendix

Part Index

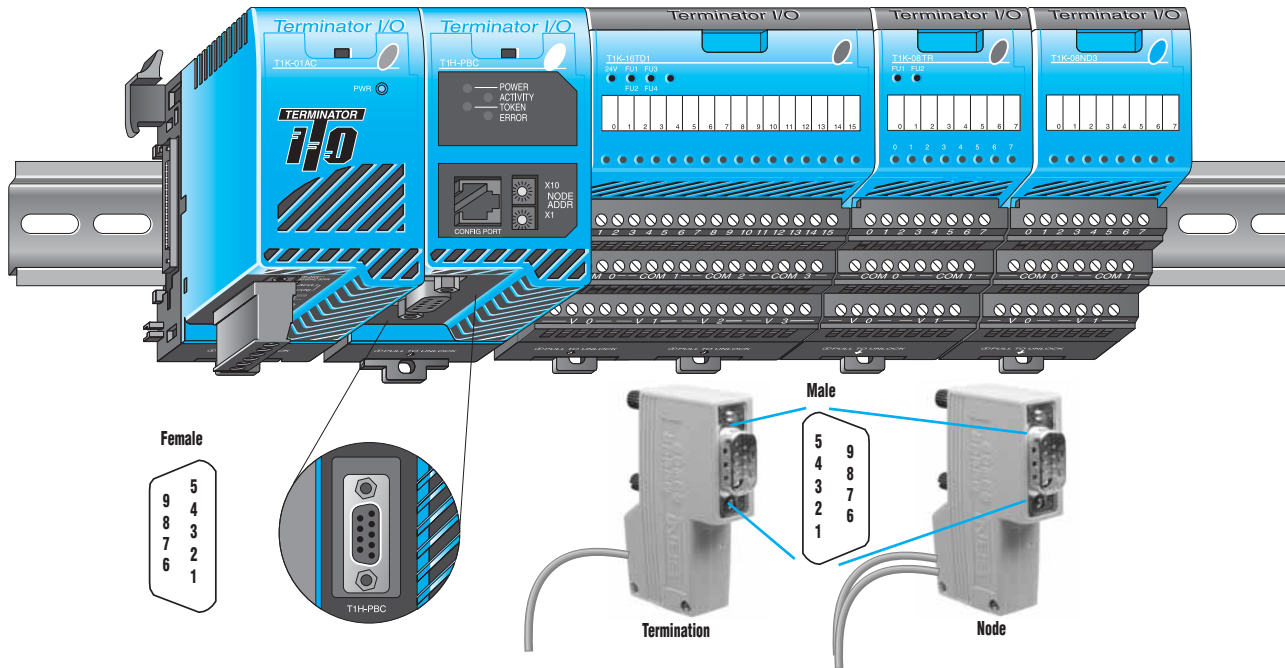

Baud	Max. Segment Length		Max. Expansion	
	Feet	Meters	Feet	Meters
9.6 Kbps	3278	1000	32786	10000
19.2 Kbps	3278	1000	32786	10000
93.75 Kbps	3278	1000	32786	10000
187.5 Kbps	3278	1000	32786	10000
500 Kbps	1311	400	13114	4000
1.5 Mbps	655	200	6557	2000
3 Mbps	327	100	3270	1000
6 Mbps	327	100	3270	1000
12 Mbps	327	100	3270	1000

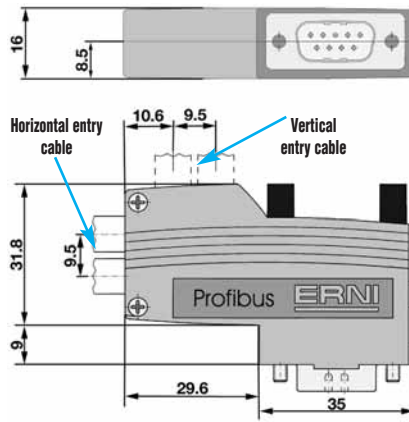

all dimensions in mm

ERNI ERbic connectors for PROFIBUS networks



Connectors are available for the PROFIBUS Base Controller. They are available in standard node and standard termination styles with vertical cable entry for Terminator I/O.

Terminator I/O Modules Supported	
Discrete Types	Analog Types
8-point DC Input	8-channel Current Input
8-point AC Input	8-channel Voltage Input
16-point DC Input	8-channel Current Output
16-point AC Input	8-channel Voltage Output
8-point DC Output	16-channel Current Input
8-point AC Output	16-channel Voltage Input
16-point DC Output	16-channel Current Output
16-point AC Output	16-channel Voltage Output
8-point Relay Output	
16-point Relay Output	

Recommended Cables	
Siemens	6XV1 830 0AH10
Belden	3079A

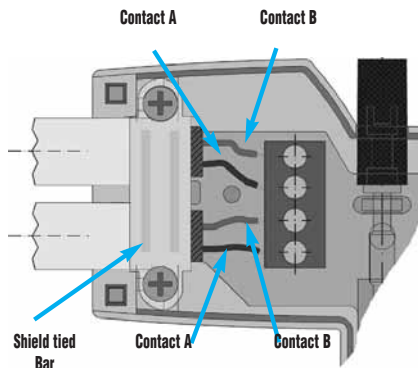

ERNI ERbic Connectors			
Part Number	Price	Description	Device
103658	<--->	PROFIBUS certified standard node vertical connector. 9-pin male D-sub	Terminator I/O T1H-PBC or any PROFIBUS ISA/ PCI Personal Computer Master/Slave Card
103659	<--->	PROFIBUS certified standard termination vertical connector 9-pin male D-sub	Terminator I/O T1H-PBC or any PROFIBUS ISA/ PCI Personal Computer Master/Slave Card

Dimensions and Installation

It is important to understand the installation requirements for your Terminator I/O system. This will ensure that the Terminator I/O products work within their environmental and electrical limits.

Plan for safety

This catalog should never be used as a replacement for the technical data sheet that comes with the products or the T1K-INST-M Installation and I/O Manual (available online at www.automationdirect.com.) The technical data sheet contains information that must be followed. The system installation should comply with all appropriate electrical codes and standards.

Unit dimensions and mounting orientation

Use the following diagrams to make sure the Terminator I/O system can be installed in your application. Terminator I/O units should be mounted horizontally. To ensure proper airflow for cooling purposes, units should not be mounted upside-down. It is important to check the Terminator I/O dimensions against the conditions required for your application. For example, it is recommended to leave 2" depth for ease of access and cable clearance. However, your distance may be greater or less. Also, check the installation guidelines for the recommended cabinet clearances.

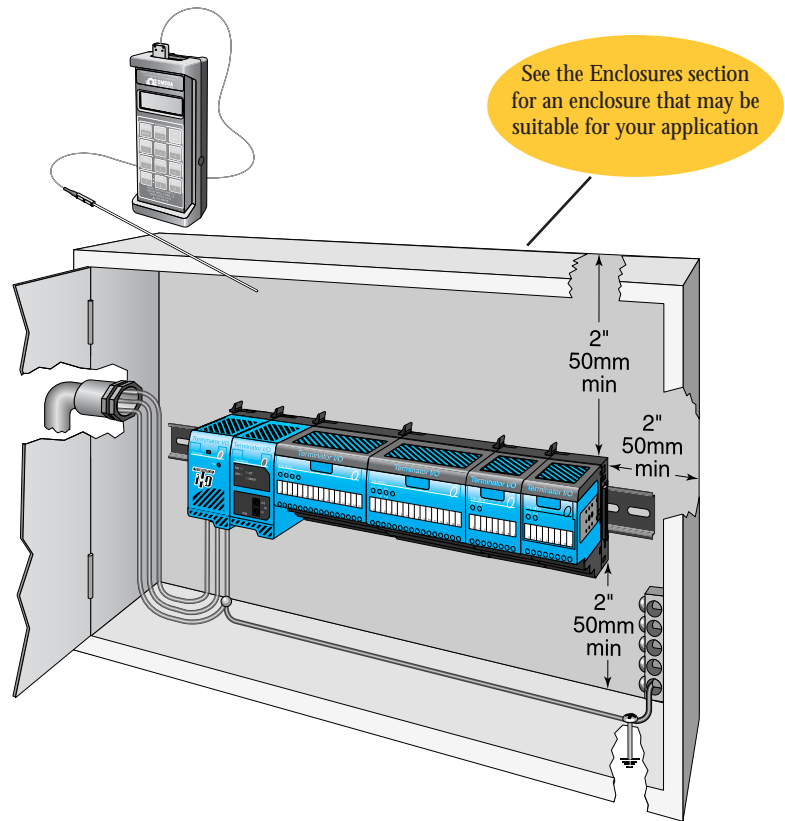

Terminator I/O Environmental Specifications	
Ambient Operating Temperature	32°F to 131°F (0°C to 55°C)
Storage Temperature	-4°F to 158°F (-20°C to 70°C)
Ambient Humidity	5% to 95% (Non-condensing)
Atmosphere	No corrosive gases. The level of environmental pollution = 2 (UL 840)
Vibration Resistance	MIL STD 810C, Method 514.2
Shock Resistance	MIL STD 810C, Method 516.2
Voltage Withstand (Dielectric)	1500 VAC, 1 minute
Insulation Resistance	500 VDC, 10 MΩ
Noise Immunity	NEMA ICS3-304 Impulse noise 1μs, 1000 V FCC class A RFI (144 MHz, 430 MHz 10 W, 10 cm)
Agency Approvals	UL, CE, FCC class A, NEC Class 1 Division 2

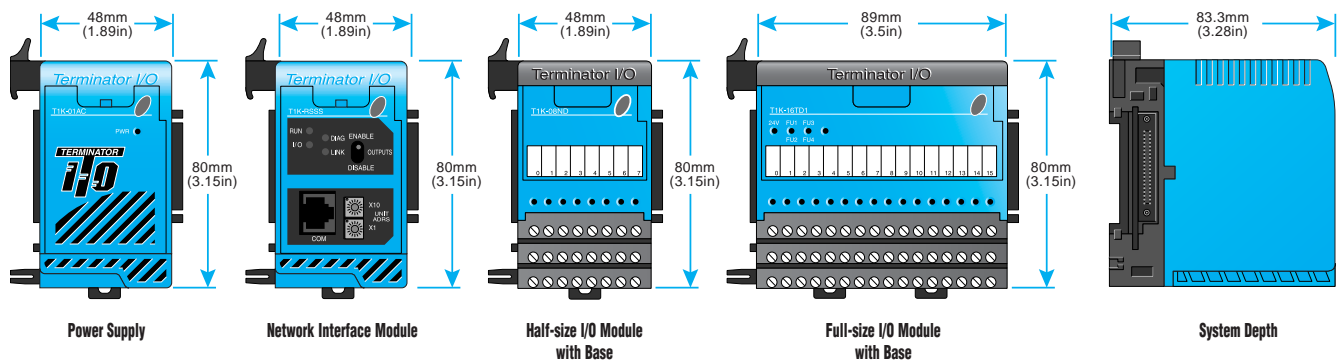

I/O Module Installation

I/O module installation

Terminator I/O modules feature separate terminal bases for easy installation.

To install I/O modules:

1. Slide the module into its terminal base (until it clicks into position)
2. Hook upper DIN rail tabs over the top of DIN rail, and press the assembly firmly onto the DIN rail.
3. Slide the module along the DIN rail until it engages with the adjacent module.

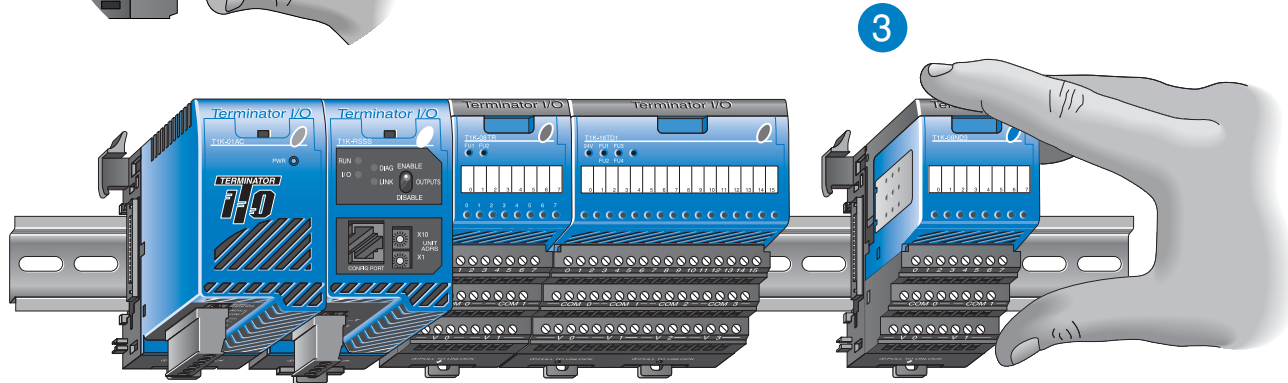
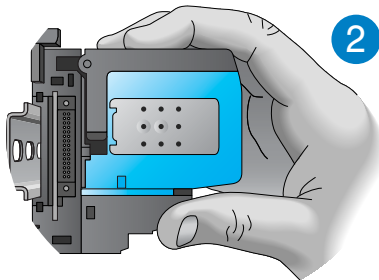
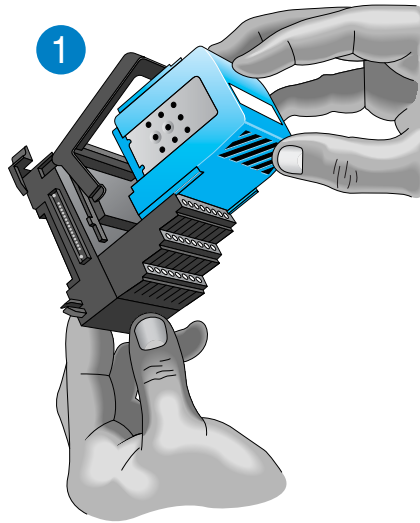

DN-ASB-1 angled mounting bracket

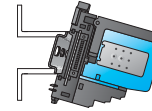
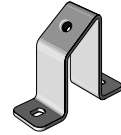

Great for mounting in upper locations

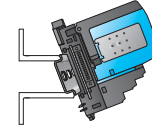

Great for mounting in lower locations

Optional angled support bracket raises and tilts the mounting rail for easier access and wiring. Use with 35 mm DIN rail. See the Connection Systems in this catalog for details.

Removing I/O modules is a snap

Grip the locking handle, as shown, and pull gently to eject the I/O module from its base. The module will slide out for easy replacement. This procedure does not apply to network interface modules or power supplies, which have integral bases.

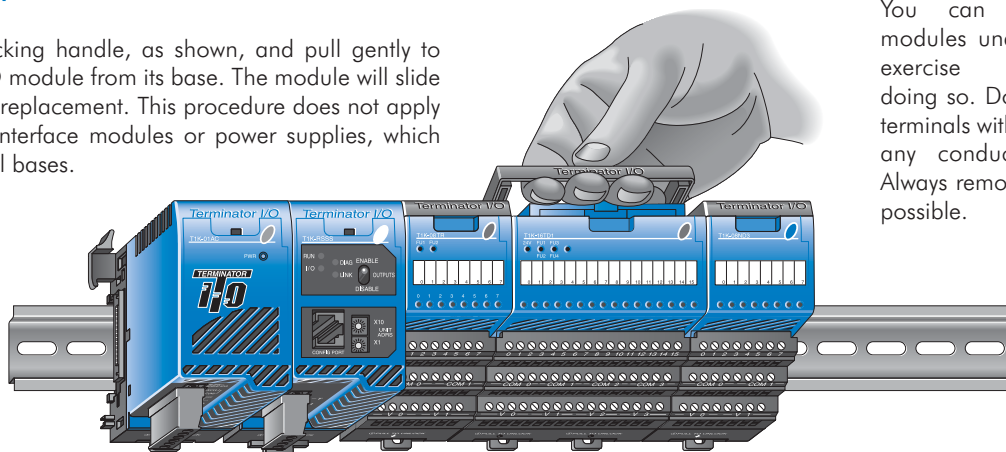

Hot-swappable I/O modules

You can remove I/O modules under power, but exercise caution while doing so. Do not touch the terminals with your hands or any conductive material. Always remove power when possible.

Power Supplies and Power Requirements

Power supplies

The Terminator I/O product line offers two power supply options: AC or DC. The power supplies are always positioned to the left of the modules to which they supply power. Consult the system configuration examples and the power budgeting example for more information on positioning power supplies.

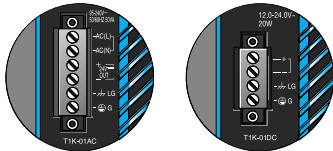

Power supply specifications

Power Supply Specifications		T1K-01AC ←---→	T1K-01DC ←---→
Input Voltage Range		110/220 VAC	12/24 VDC
Input Frequency		50/60 Hz	N/A
Maximum Power		50 VA	30 W
Max. Inrush Current		20 A	10 A
Insulation Resistance		> 10 MΩ @ 500 VDC	
Voltage Withstand		1 min. @ 1500 VAC between primary, secondary and field ground	
5VDC PWR	Voltage	5.25 VDC	5.25 VDC
	Current Rating	2000 mA max (see current option note below)	2000 mA max
	Ripple	5% max.	5% max.
24VDC PWR	Voltage	24 VDC	N/A
	Current Rating	300 mA max. (see current option note below)	N/A
	Ripple	10% max.	N/A
Fuse		1 (primary), not replaceable	
Note: 500 mA @ 24 VDC can be achieved by lowering the 5VDC from 2000 mA to 1500 mA.			

Power requirements

Module	5VDC	24VDC	Module	5VDC	24VDC	Module	5VDC	24VDC
Interface Modules			DC Output Modules			Analog Input Modules		
T1H-EBC	350	0	T1H-08TDS	200	0	T1F-08AD-1	75	50*
T1H-EBC100	300	0	T1K-08TD1	100	200*	T1F-08AD-2	75	50*
T1H-PBC	530	0	T1K-16TD1	200	400*	T1F-16AD-1	75	50*
T1K-DEVNETS	250	45	T1K-08TD2-1	200	0	T1F-16AD-2	75	50*
T1K-RSSS	250	0	T1K-16TD2-1	200	0	T1F-14THM	60	70*
T1K-MOVBUS	300	0	AC Output Modules			T1F-16RTD	150	0
DC Input Modules			AC Input Modules			Analog Output Modules		
T1K-08ND3	35	0	T1K-08TA	250	0	T1F-08DA-1	75	75*
T1K-16ND3	70	0	T1K-16TA	450	0	T1F-08DA-2	75	75*
AC Input Modules			Relay Output Modules			Combination Analog Modules		
T1K-08NA-1	35	0	T1K-08TR	350	0	T1F-16DA-1	75	150*
T1K-16NA-1	70	0	T1K-16TR	700	0	T1F-16DA-2	75	150*
			Specialty Modules			Specialty Modules		
			T1H-CTRIO			T1F-8AD4DA-1		
			* Use either internal or external source for 24VDC			T1F-8AD4DA-2		
						* Use either internal or external source for 24VDC		

Calculating the power budget

To calculate the power budget, read the available power (current rating) from the Power Supply Specifications table and subtract the power consumed by each module to the right of the power supply. Do not include modules to the right of an additional power supply.

Adding additional power supplies

Each power supply furnishes power only to the network interface and I/O modules to its right. Inserting a second power supply closes the power loop for the power supply to the left, while also powering the modules to its right. Perform a power budget calculation for each power supply in the system.

Power Budget Example		
Module	5VDC	24VDC
T1K-01AC	+2000 mA	+300 mA
T1H-EBC	-350 mA	-0 mA
T1K-16ND3	-70 mA	-0 mA
T1K-16TD2	-200 mA	-0 mA
T1F-08AD-1	-75 mA	-50 mA
Remaining	+1305 mA	+250 mA

Accessories available for Terminator I/O are listed in the Terminator Field I/O section of the Price List

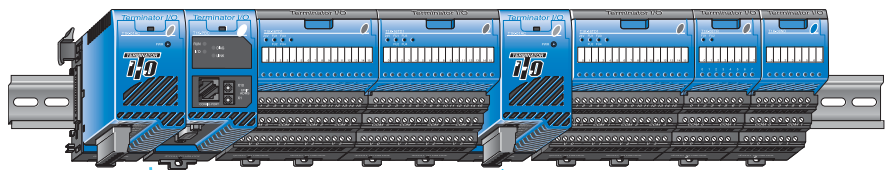

This power supply powers the network interface module and the next two I/O modules

This power supply powers these three I/O modules

Expansion I/O Configurations

Expansion cables

T1K-10CBL <--->
T1K-10CBL-1* <--->
Right side to left side expansion cable

The T1K-10CBL(-1) connects the right side of an I/O base to the left side of the next I/O base. A maximum of two T1K-10CBL(-1) cables can be used per expansion system.

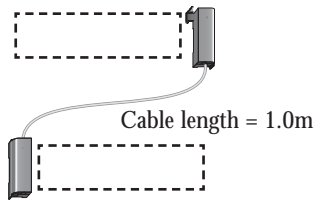

T1K-05CBL-LL <--->
T1K-05CBL-LL-1* <--->
Left side to left side expansion cable

The T1K-05CBL-LL(-1) connects the left side of an I/O base to the left side of the next I/O base. Only one T1K-05CBL-LL(-1) cable can be used per expansion system and must be used with a T1K-05CBL-RR(-1) cable. **This cable cannot be connected to the left side of the network interface base.**

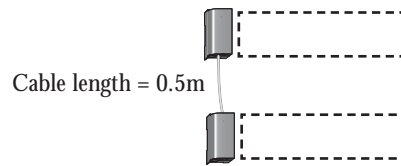

T1K-05CBL-RR <--->
T1K-05CBL-RR-1* <--->
Right side to right side expansion cable

The T1K-05CBL-RR(-1) connects the right side of an I/O base to the right side of the next I/O base. A maximum of one T1K-05CBL-RR(-1) cable can be used per expansion system. **Note: When this cable is used, the expansion I/O assignments are from right to left (reversed).**

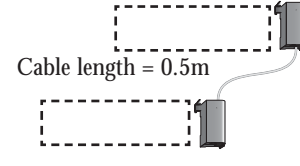

***Note:** The (-1) versions of the expansion cables pass 24 VDC through on an isolated wire. (All cables pass the 5 VDC base power.) Any local expansion DC input module configured for "internal power" (current sourcing) must either have a power supply preceding it on the same base or, have a (-1) version cable pass 24 VDC from a power supply on the preceding base.

Using two T1K-10CBL expansion cables

In the system below, power supplies can be used anywhere.

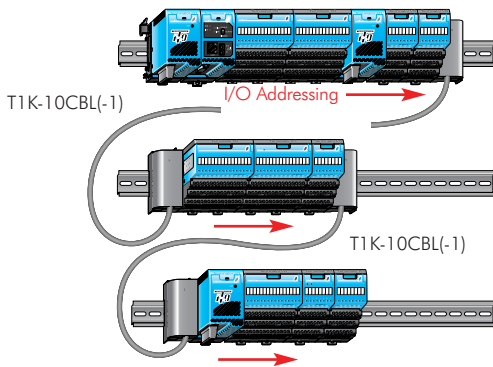

Using T1K-10CBL expansion cable and T1K-05CBL-RR expansion cable

Power supplies can be used anywhere in the first two bases, but not in the last expansion base.

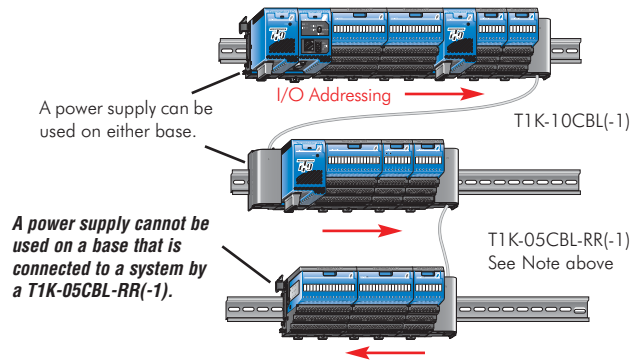

Using T1K-05CBL-RR expansion cable and T1K-05CBL-LL expansion cable

Power supplies can be used anywhere in the first and third bases, but not in the second base.

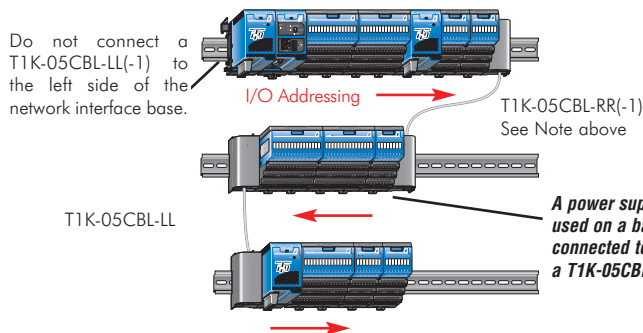

Using T1K-05CBL-RR expansion cable

Power supplies can be used anywhere in the first base, but not in the second base.

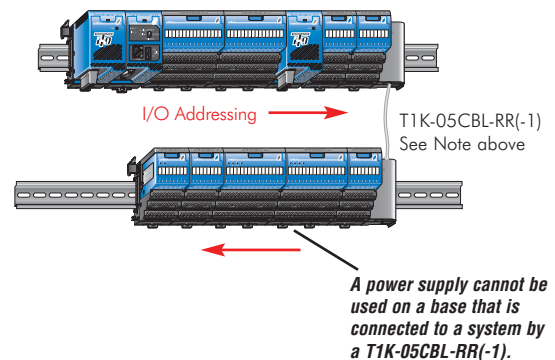

Field Device Wiring and Power Options

Terminal base specifications

Terminator I/O terminal bases are available in screw clamp and spring clamp versions for both half-size and full-size modules. Hot stamp silkscreen labeling is used for numbering I/O points, commons, and all power terminals.

Terminal Base Specifications		
Terminal Type	Screw type	Spring clamp
Recommended Torque	1.77-3.54 lb-in (0.2 - 0.4 Nm)	n/a
Wire Gauge	Solid: 25-12 AWG Stranded: 26-12 AWG	Solid: 25-14 AWG Stranded: 26-14 AWG

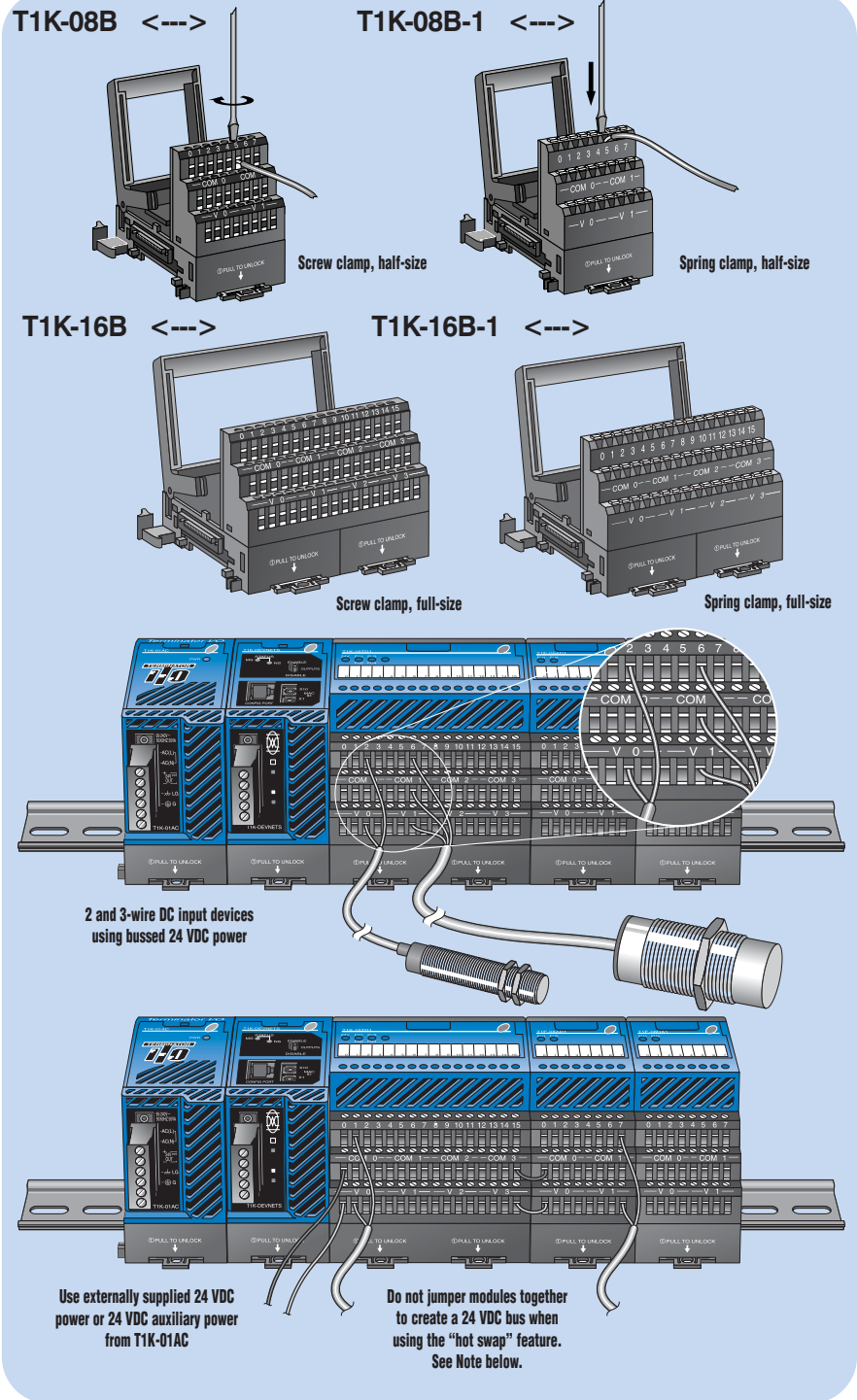

Field device wiring options

Power your DC input devices from the integrated 24 VDC power supply bus. T1K-08ND3 and T1K-16ND3 DC input modules include jumpers for selecting the internal 24 VDC power supply available for 2- and 3-wire field devices. Clearly labeled triple stack terminals make it easy to wire 2- and 3-wire devices ensuring clean wiring with only one wire per termination.

External user supplied 24 VDC power, or auxiliary 24 VDC terminals from T1K-01AC, can be easily applied directly to one end of the terminal rows and jumpered across each base in the system.

This is a convenient solution for powering analog I/O and discrete DC output devices whose modules do not have direct access to the internal bussed 24 VDC. If current consumption increases, simply add additional T1K-01AC power supplies into the system.

Hot-swap feature

The hot-swap feature allows Terminator I/O modules to be replaced while system power is on. Be careful not to touch the terminals with your hands or other conductive material to avoid the risk of personal injury or equipment damage. Always remove power if it is equally convenient to do so.

Note: Before hot-swapping analog or DC output modules in a Terminator I/O system, make sure that each of the analog and DC output module's 24 VDC and 0 VDC base terminals are wired directly to the external power supply individually. If the external 24 VDC and 0 VDC is jumpered from base to base in a daisy

chain fashion, and an analog or DC output module is removed from its base, the risk of disconnecting the external 24 VDC and 0 VDC to the subsequent I/O modules exists.