

DC Output Modules

8-point and 16-point, current sinking DC output modules

The 8-point DC module uses a T1K-08B or T1K-08B-1 base, which is purchased separately.

The 16-point DC module uses a T1K-16B or T1K-16B-1 base, which is purchased separately.

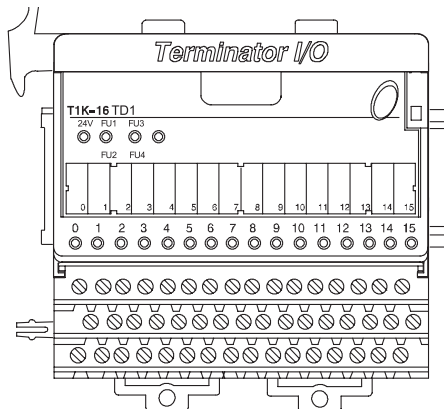
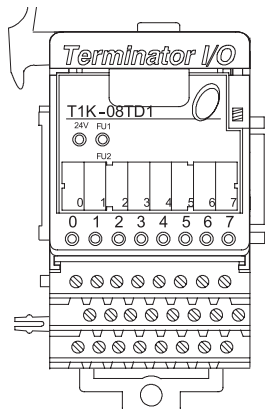

Specifications	T1K-08TD1	T1K-16TD1
Outputs per Module	8 (sink)	16 (sink)
Commons per Module	2 internally connected	4 internally connected
Operating Voltage Range	6–27 VDC min./max.	
Output Voltage Range	5–30 VDC min. / max.	
Peak Voltage	50VDC	
Max. Output Current	1A / pt., 4A / common	
Max. Leakage Current	15µA @ 30VDC	
ON Voltage Drop	0.3 VDC @ 1.0 A	
Max. Inrush Current	2A for 100ms	
OFF to ON Response	< 10µs	
ON to OFF Response	< 60µs	
Base Power Required	100mA @ 5VDC	200mA @ 5VDC
External Power Required	200mA max. @ 20–28 VDC	400mA max. @ 20–28 VDC
Status Indicators	Logic side	
Error Status Indicators	24V ON = low external power	
	FU1/FU2 ON = blown fuse	FU1/FU2 ON = fuse 1 or 2 blown FU3/FU4 ON = fuse 3 or 4 blown
Fuses (User Replaceable) T1K-FUSE-1	2	
	(6.3 A, 250 V / common) NQ3-6.3 SOC Corp.	
Weight	85g	140g

Equivalent Output Circuit

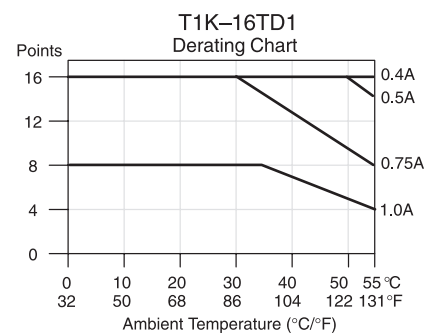
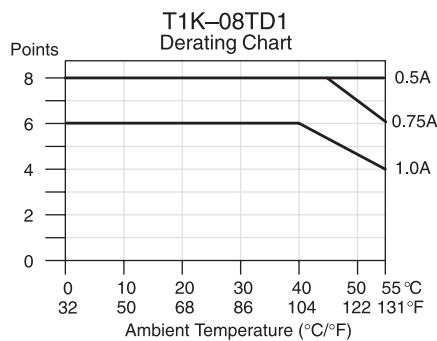
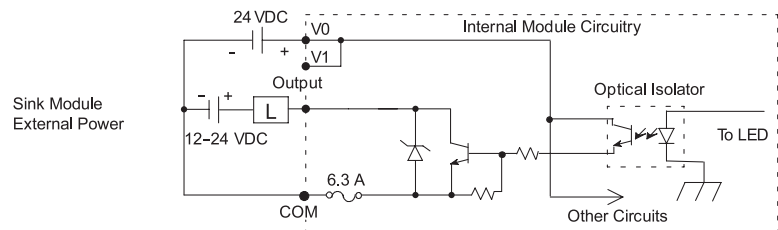

Dimensions and Installation

It is important to understand the installation requirements for your Terminator I/O system. This will ensure that the Terminator I/O products work within their environmental and electrical limits.

Plan for safety

This catalog should never be used as a replacement for the technical data sheet that comes with the products or the T1K-INST-M Installation and I/O Manual (available online at .) The technical data sheet contains information that must be followed. The system installation should comply with all appropriate electrical codes and standards.

Unit dimensions and mounting orientation

Use the following diagrams to decide if the Terminator I/O system can be installed in your application. Terminator I/O units should be mounted horizontally. To ensure proper airflow for cooling purposes, units should not be mounted upside-down. It is important to check the Terminator I/O dimensions against the conditions required for your application. For example, it is recommended to leave 2" depth for ease of access and cable clearance. However, your distance may be greater or less. Also, check the installation guidelines for the recommended cabinet clearances.

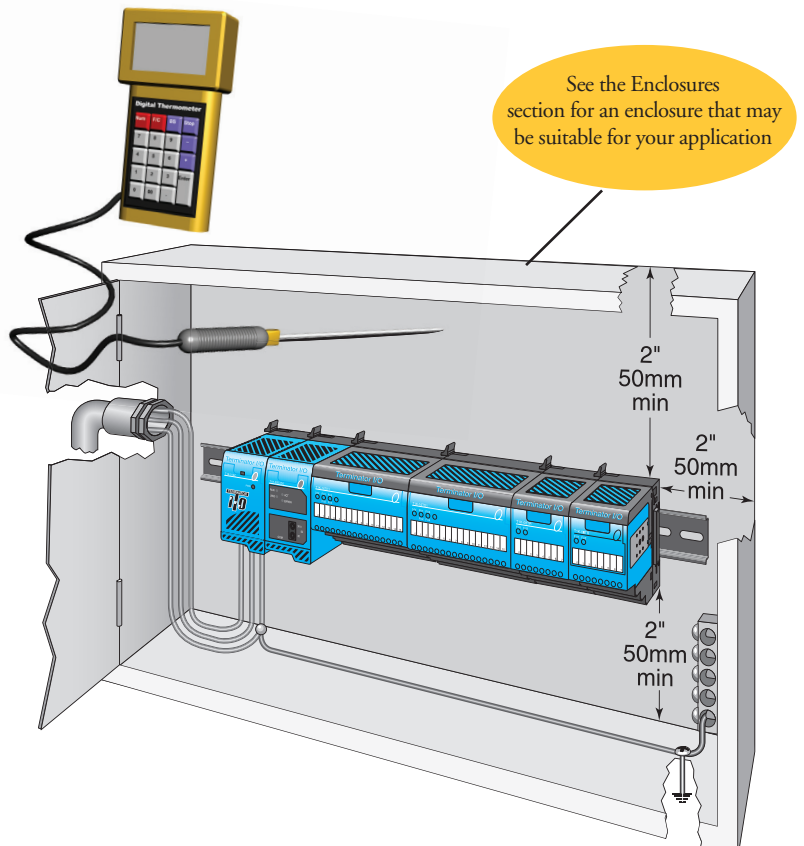

Terminator I/O Environmental Specifications	
Ambient Operating Temperature	32°F to 131°F (0°C to 55°C)
Storage Temperature	-4°F to 158°F (-20°C to 70°C)
Ambient Humidity	5% to 95% (Non-condensing)
Atmosphere	No corrosive gases. The level of environmental pollution = 2 (UL 840)
Vibration Resistance	MIL STD 810C, Method 514.2
Shock Resistance	MIL STD 810C, Method 516.2
Voltage Withstand (Dielectric)	1500VAC, 1 minute
Insulation Resistance	500 VDC, 10 MΩ
Noise Immunity	NEMA ICS3-304 Impulse noise 1μs, 1000V FCC class A RFI (144MHz, 430MHz 10W, 10cm)
Agency Approvals	UL, CE, FCC class A, NEC Class 1 Division 2

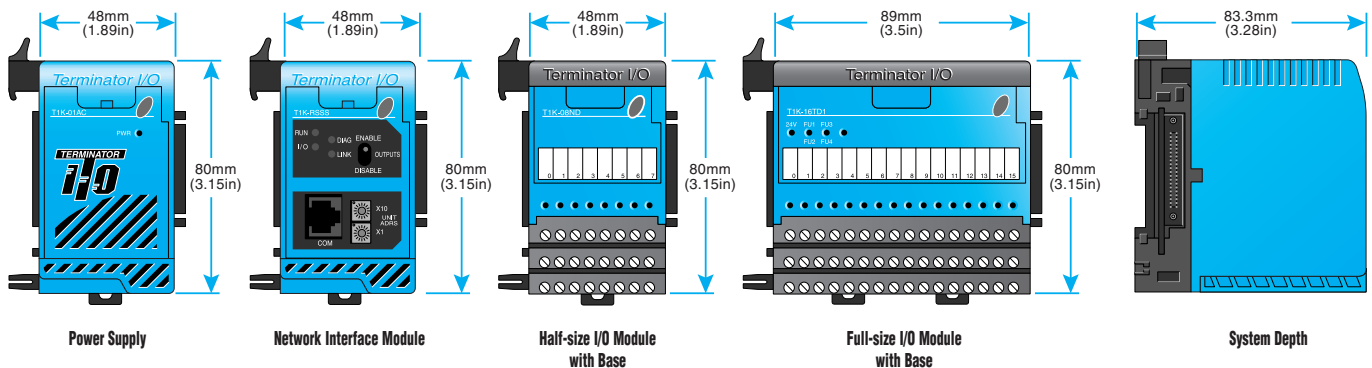

I/O Module Installation

I/O module installation

Terminator I/O modules feature separate terminal bases for easy installation.

To install I/O modules:

1. Slide the module into its terminal base (until it clicks into position)
2. Hook upper DIN rail tabs over the top of DIN rail, and press the assembly firmly onto the DIN rail.
3. Slide the module along the DIN rail until it engages with the adjacent module.

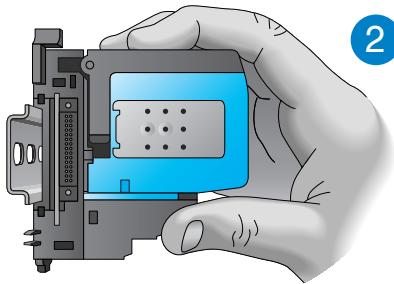
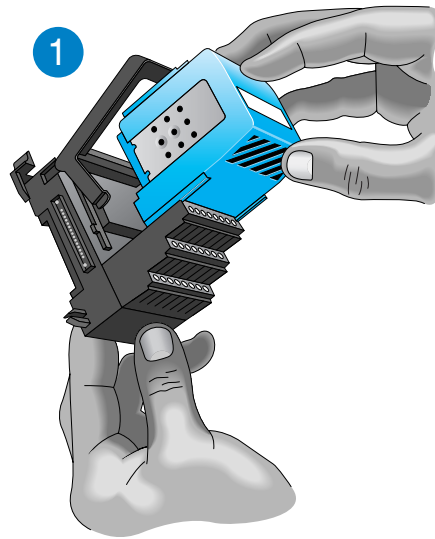

DN-ASB-1 angled mounting bracket

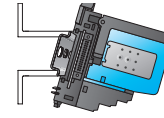
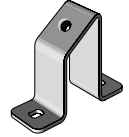

Great for mounting in upper locations

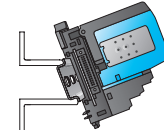

Great for mounting in lower locations

Optional angled support bracket raises and tilts the mounting rail for easier access and wiring. Use with 35mm DIN rail. See the Connection Systems in this catalog for details.

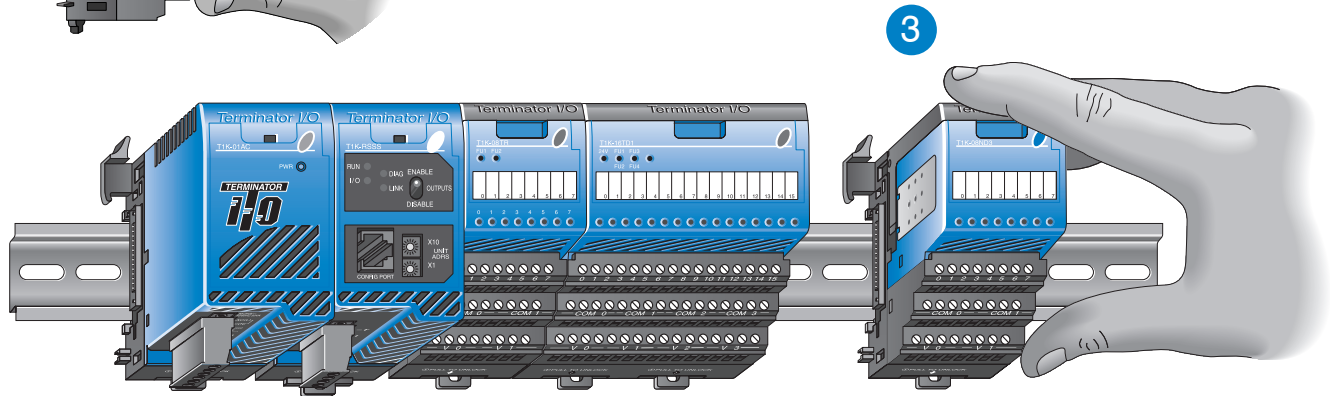

Removing I/O modules is a snap

Grip the locking handle, as shown, and pull gently to eject the I/O module from its base. The module will slide out for easy replacement. This procedure does not apply to network interface modules or power supplies, which have integral bases.

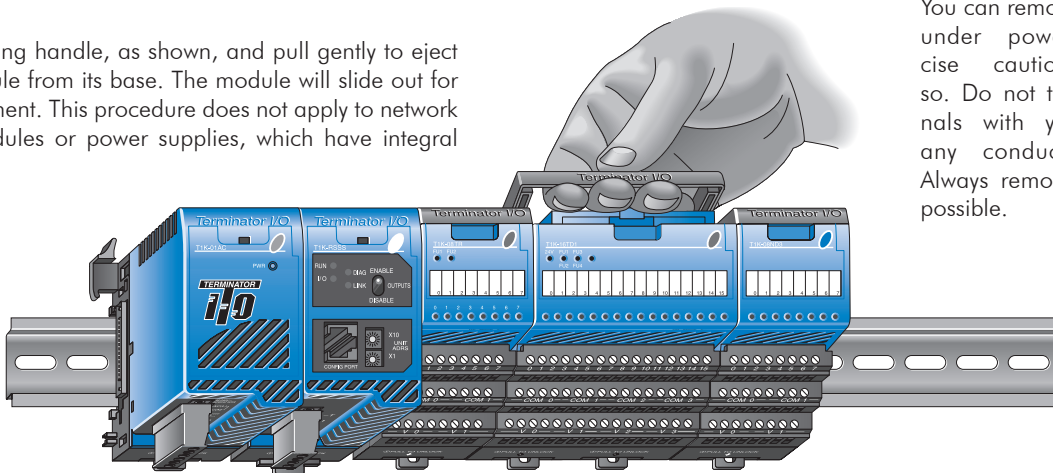

Hot-swappable I/O modules

You can remove I/O modules under power, but exercise caution while doing so. Do not touch the terminals with your hands or any conductive material. Always remove power when possible.

Power Supplies and Power Requirements

Power supplies

The Terminator I/O product line offers two power supply options: AC or DC. The power supplies are always positioned to the left of the modules to which they supply power. Consult the system configuration examples and the power budgeting example for more information on positioning power supplies.

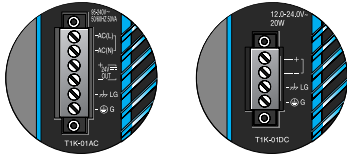

Power supply specifications

Power Supply Specifications		T1K-01AC	T1K-01DC
Input Voltage Range		110/220 VAC	12/24 VDC
Input Frequency		50/60 Hz	N/A
Maximum Power		50VA	30W
Max. Inrush Current		20A	10A
Insulation Resistance		> 10MΩ @ 500 VDC	
Voltage Withstand		1 min. @ 1500VAC between primary, secondary and field ground	
5VDC PWR	Voltage	5.25 VDC	5.25 VDC
	Current Rating	2000 mA max (see current option note below)	2000mA max
	Ripple	5% max.	5% max.
24VDC PWR	Voltage	24VDC	N/A
	Current Rating	300mA max. (see current option note below)	N/A
	Ripple	10% max.	N/A
Fuse		1 (primary), not replaceable	
Replacement Terminal Block (Phoenix Contact)		MVSTBW 2.5/4-ST-5.08 BK	MVSTBW 2.5/6-ST-5.08 BK
Note: 500mA @ 24VDC can be achieved by lowering the 5VDC from 2000mA to 1500mA.			

Power requirements

Module	5VDC	24VDC	Module	5VDC	24VDC	Module	5VDC	24VDC
Interface Modules			DC Output Modules			Analog Input Modules		
T1H-EBC100	300	0	T1H-08TDS	200	0	T1F-08AD-1	75	50*
T1K-DEVNETS	250	45	T1K-08TD1	100	200*	T1F-08AD-2	75	50*
T1K-MODBUS	300	0	T1K-16TD1	200	400*	T1F-16AD-1	75	50*
DC Input Modules			T1K-08TD2-1	200	0	T1F-16AD-2	75	50*
T1K-08ND3	35	0	T1K-16TD2-1	200	0	T1F-16RTD	150	0
T1K-16ND3	70	0	AC Output Modules			T1F-16TMST	150	0
AC Input Modules			T1K-08TA	250	0	T1F-14THM	60	70*
T1K-08NA-1	35	0	T1K-16TA	450	0	Analog Output Modules		
T1K-16NA-1	70	0	T1K-08TAS	300	0	T1F-08DA-1	75	150*
			Relay Output Modules			T1F-08DA-2	75	150*
			T1K-08TR	350	0	T1F-16DA-1	75	150*
			T1K-16TR	700	0	T1F-16DA-2	75	150*
			T1K-08TRS	400	0	Combination Analog Modules		
			Specialty Modules			T1F-8AD4DA-1	75	60*
			T1H-CTRIO	400	0	T1F-8AD4DA-2	75	70*
			* Use either internal or external source for 24VDC			* Use either internal or external source for 24VDC		

Calculating the power budget

To calculate the power budget, read the available power (current rating) from the Power Supply Specifications table and subtract the power consumed by each module to the right of the power supply. Do not include modules to the right of an additional power supply.

Power Budget Example		
Module	5VDC	24VDC
T1K-01AC	+2000mA	+300mA
T1H-EBC100	-300mA	-0mA
T1K-16ND3	-70mA	-0mA
T1K-16TD2	-200mA	-0mA
T1F-08AD-1	-75mA	-50mA
Remaining	+1355mA	+250mA

Adding additional power supplies

Each power supply furnishes power only to the network interface and I/O modules to its right. Inserting a second power supply closes the power loop for the power supply to the left, while also powering the modules to its right. Perform a power budget calculation for each power supply in the system.

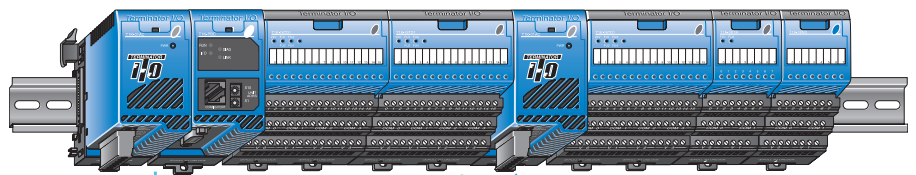

This power supply powers the network interface module and the next two I/O modules

This power supply powers these three I/O modules

Expansion I/O Configurations

Expansion cables

T1K-10CBL

T1K-10CBL-1*

Right side to left side
expansion cable

The T1K-10CBL(-1) connects the right side of an I/O base to the left side of the next I/O base. A maximum of two T1K-10CBL(-1) cables can be used per expansion system.

***Note:** The (-1) versions of the expansion cables pass 24VDC through on an isolated wire. (All cables pass the 5VDC base power.) Any local expansion DC input module configured for "internal power"

(current sourcing) must either have a power supply preceding it on the same base or, have a (-1) version cable pass 24VDC from a power supply on the preceding base.

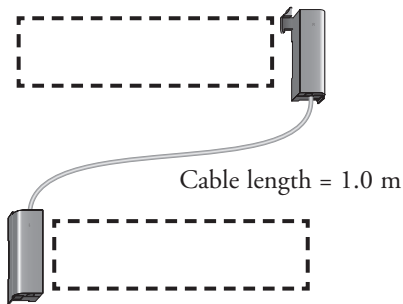

Using two T1K-10CBL expansion cables

In the system below, power supplies can be used anywhere.

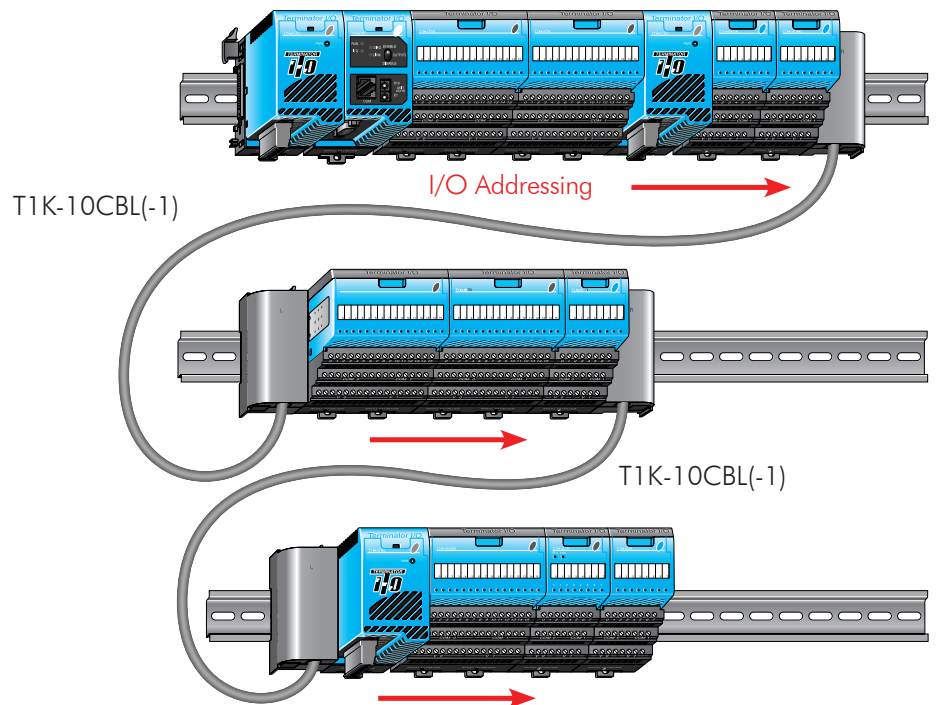

Field Device Wiring and Power Options

Terminal base specifications

Terminator I/O terminal bases are available in screw clamp and spring clamp versions for both half-size and full-size modules. Hot stamp silk screen labeling is used for numbering I/O points, commons, and all power terminals.

Terminal Base Specifications		
Terminal Type	Screw type	Spring clamp
Recommended Torque	1.77–3.54 lb-in (0.2–0.4 N-m)	N/A
Wire Gauge	Solid: 25–12 AWG Stranded: 26–12 AWG	Solid: 25–14 AWG Stranded: 26–14 AWG

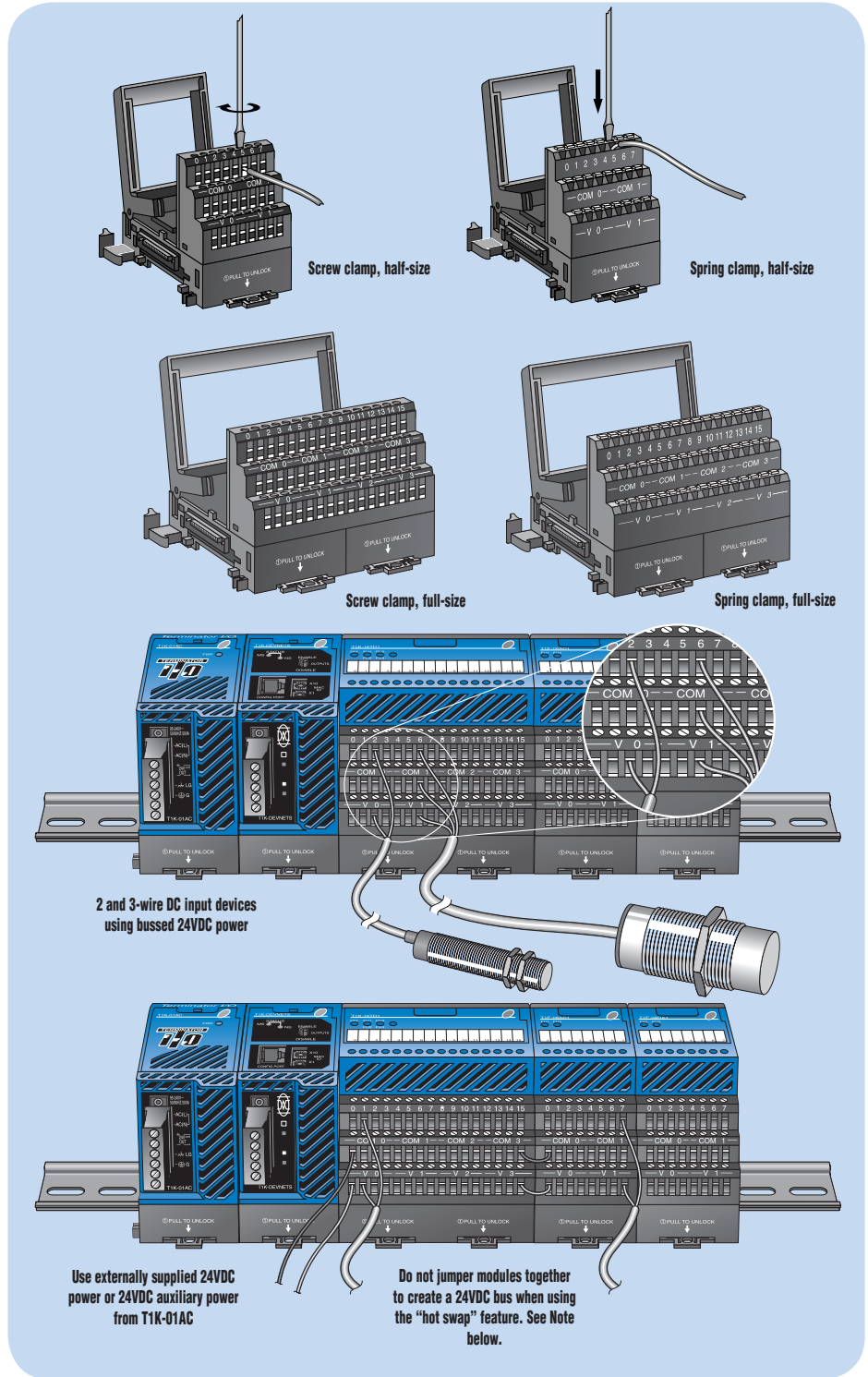

Field device wiring options

Power your DC input devices from the integrated 24VDC power supply bus. T1K-08ND3 and T1K-16ND3 DC input modules include jumpers for selecting the internal 24VDC power supply available for 2- and 3-wire field devices. Clearly labeled triple stack terminals make it easy to wire 2- and 3-wire devices ensuring clean wiring with only one wire per termination.

External user supplied 24VDC power, or auxiliary 24VDC terminals from T1K-01AC, can be easily applied directly to one end of the terminal rows and jumpered across each base in the system.

This is a convenient solution for powering analog I/O and discrete DC output devices whose modules do not have direct access to the internal bussed 24VDC. If current consumption increases, simply add additional T1K-01AC power supplies into the system.

Hot-swap feature

The hot-swap feature allows Terminator I/O modules to be replaced while system power is on. Be careful not to touch the terminals with your hands or other conductive material to avoid the risk of personal injury or equipment damage. Always remove power if it is equally convenient to do so.

Note: Before hot-swapping analog or

DC output modules in a Terminator I/O system, make sure that each of the analog and DC output module's 24VDC and 0 VDC base terminals are wired directly to the external power supply individually. If the external 24VDC and 0 VDC is jumpered from base to base in a daisy chain fashion, and an analog or DC output module is

removed from its base, the risk of disconnecting the external 24VDC and 0 VDC to the subsequent I/O modules exists.