

Fuse modules provide fuse protection for PLC output devices. Use with Do-more, CLICK, DL05/06/205/305/405 PLCs.

Modules mount on 35mm DIN rail (part #DN-R35S1) or 15mm DIN rail (part #DN-R15S1).

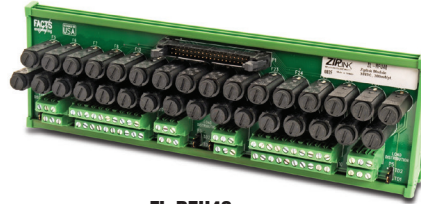

ZL-RFU20



ZL-RFU40

Specifications								
Fuse Modules	Part #	Pcs/ Pkg	Price/ Pkg	Weight (lbs)	Part #	Pcs/ Pkg	Price/ Pkg	Weight (lbs)
		ZL-RFU20	1		0.79	ZL-RFU40	1	
Description ⁴	16-point fuse connector module				32-point fuse connector module			
Operation Voltage	0–250 VAC/0–75 VDC ¹				0–30 VDC			
UL Rated Current	1A per point				0.3 A per circuit ²			
Maximum Current per Circuit	2A				0.4 A			
Maximum Current per Module	32A				20A			
Number of Circuits	16				32			
Field to Logic Side Isolation	1800VAC applied for 1 second							
Insulation Resistance	>10MΩ @ 500VDC							
Surrounding Temperature Range	32 to 140°F (0 to 60°C)							
Terminal Block Contacts	Copper alloy, tin-lead plated							
Wire Range (Rated Cross Section) ³	12–24 AWG Solid or Stranded Copper Conductor (2.5 mm ²)							
Wire Strip Length	0.24–0.27 in (6–7 mm)							
Screw Torque	4.4 in-lbs (0.5 N-m)							
Fuses (Not Included)	Sixteen 5x20 mm, 250V, 2 Amp fast blow				Thirty-two 5x20 mm, 250V, 0.4 Amp fast blow			
Replacement Fuse	See Edison 5x20 mm Glass Fuse Section range up to a Max. 2 Amp fuse				See Edison 5x20 mm Glass Fuse Section range up to a Max. 0.4 Amp fuse			
Connector Type	Molex Micro-Fit 3.0, 24 pin connector Example receptacle 43020-2400, Pins 43031 Series, Male				3M 34000 Series IDC Connector, strain relief is required to latch to header. Example: Socket 3417-7640, Strain relief 3448-3040			
Connecting Cables (Sold Separately)	Click on link: Wiring Selection Guides . Click on link: Connection Cable Specifications Tables .							
Cable/Wire Clearance	0.5 in (12.7 mm) Required							
Mounting Restrictions	None							
Approvals	File # E200031 UL, cUL, Class 1, Division 2, Groups A,B,C,D Hazardous Locations, CE, EN 61131-2:2007							

¹ UL rated 0–75 VDC applies when using a DC rated fuse (not supplied), example: Littelfuse 217 series.

² Use Class 2 power supply - This refers to the ZL-RFU40 only.

³ Use conductors rated 60°/75°C

⁴ Connecting cables are for internal wiring only.

 NOTE: SEE WIRING DETAILS AND DIMENSIONAL DRAWINGS ON OUR WEB SITE AT: <http://static/manuals/ziplinks/ziplinks.html>.

Module Dimensions

ZL-RFU20

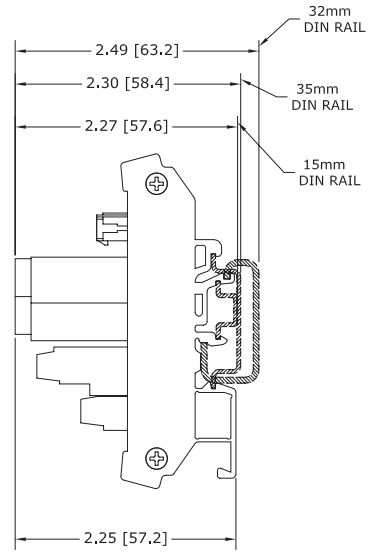
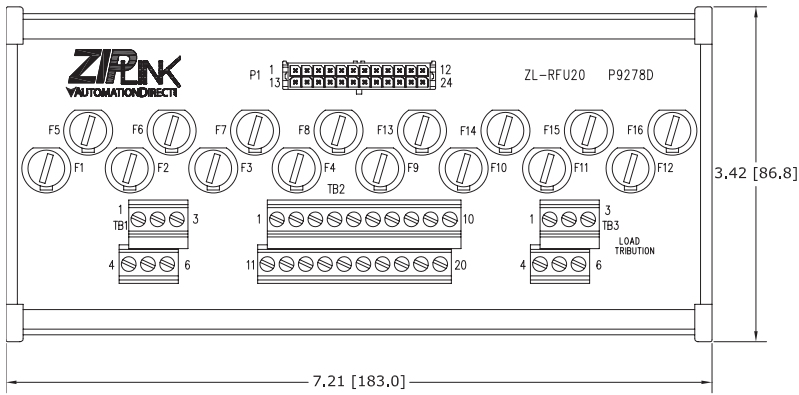

ZL-RFU40

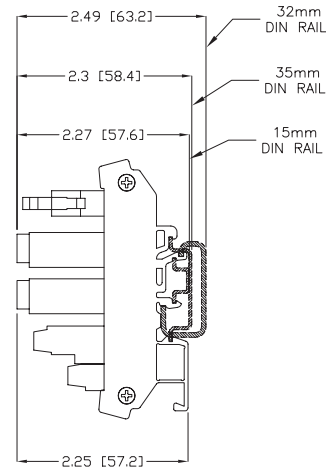
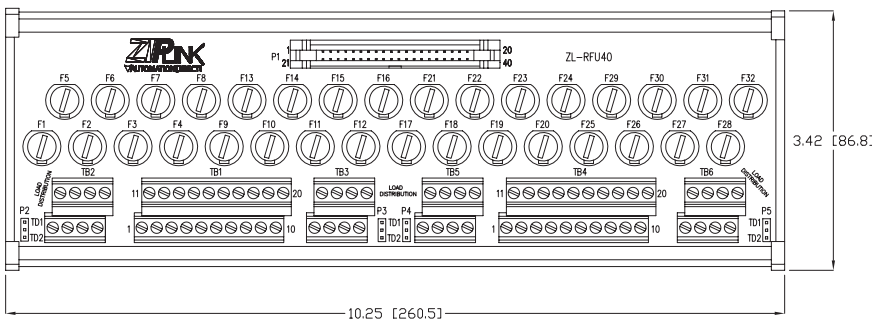

ZL-FUSE-16

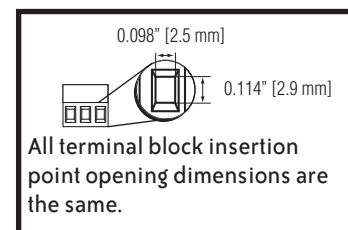
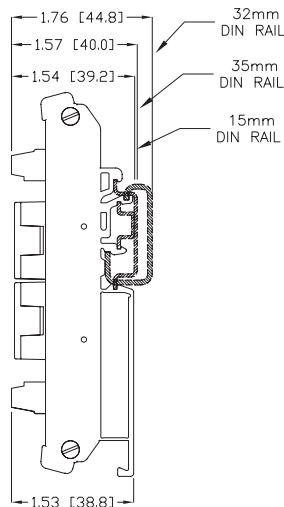
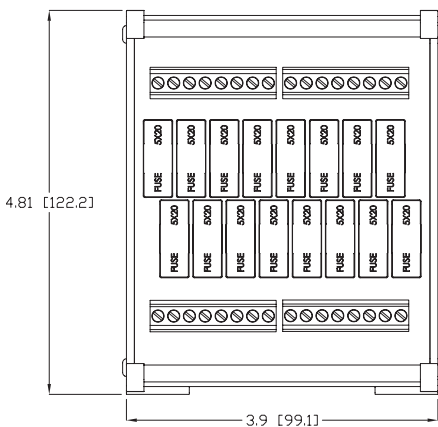

Note: Dimensions shown in Inches [mm]