

# Common Connector Module

Common Connection standalone module provides low-cost and compact field wiring screw termination solutions for power and ground connections. Module mounts on 35mm DIN rail (part #DN-R35S1) or 15mm DIN rail (part #DN-R15S1).



**ZL-RTB-COM**

Input Terminal Block Specifications				
Feedthrough Module	Part #	Pcs/Pkg	Price/Pkg	Weight (lbs)
		ZL-RTB-COM	1	
<b>Description</b>	40-Pole Common Connector Module			
<b>Voltage Rating</b>	250 VAC/VDC			
<b>Maximum Operating Range</b>	300 VAC/VDC			
<b>Maximum Current</b>	10A (Total all 40 positions), 0.5 A/pt			
<b>Terminal Block Contacts</b>	Copper alloy, tin-lead plated			
<b>Wire Range (Rated Cross Section)</b>	12–24 AWG Solid or Stranded Copper Conductor (2.5 mm <sup>2</sup> )			
<b>Wire Strip Length</b>	0.24–0.27 in (6–7 mm)			
<b>Screw Size</b>	M2.5			
<b>Screw Torque</b>	3.5 in-lbs (0.4 N-m)			

Common Specifications	
<b>Operating Temperature</b>	0 to 60°C (32 to 140°F) IEC 60068-2-14 (Test Nb, Thermal Shock)
<b>Storage Temperature</b>	-20 to 70°C (-4 to 158°F) IEC 60068-2-1 (Test Ab, Cold) IEC 60068-2-2 (Test Bb, Dry Heat) IEC 60068-2-14 (Test Na, Thermal Shock)
<b>Humidity</b>	5 to 95% (Non-condensing) IEC 60068-2-30 (Test Db, Damp Heat)
<b>Environmental Air</b>	No corrosive gases permitted (EN61131-2 pollution degree 1)
<b>Vibration Resistance</b>	MIL STD 810C 514.2 IEC60068-2-6 (Test Fc)
<b>Shock Resistances</b>	MIL STD 810C 516.2 IEC60068-2-27 (Test Ea)
<b>Agency Approvals</b>	UL 508 File E139594, Canada & USA CE (EN61131-2:2007)



NOTE: SEE WIRING DETAILS AND DIMENSIONAL DRAWINGS ON OUR WEB SITE AT:  
<http://static/manuals/ziplinks/ziplinks.html>.

# Module Dimensions

## ZL-RFU20

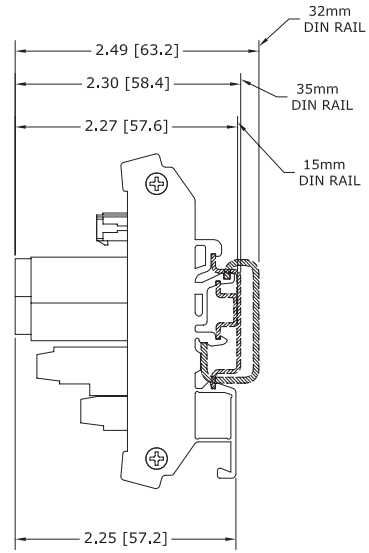
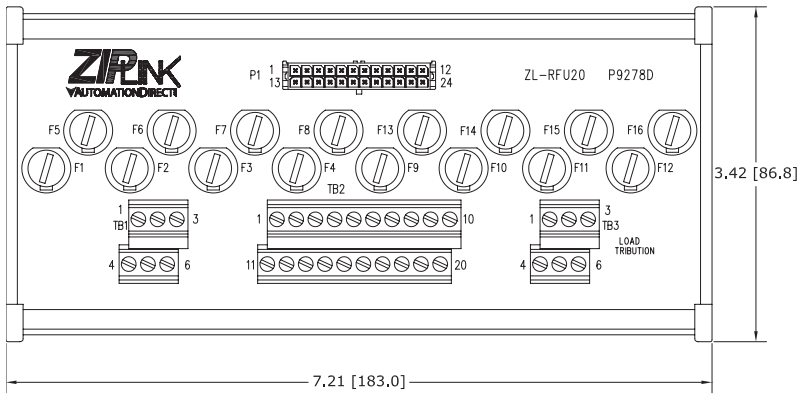

## ZL-RFU40

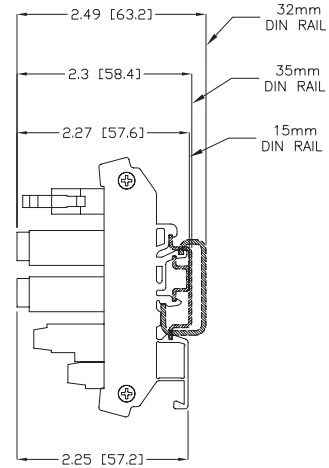
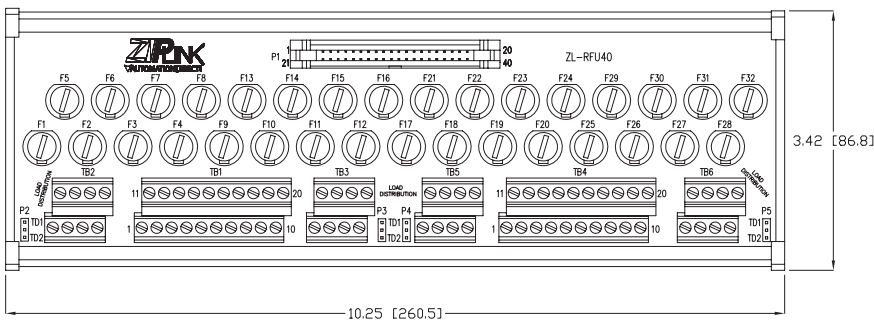

## ZL-FUSE-16

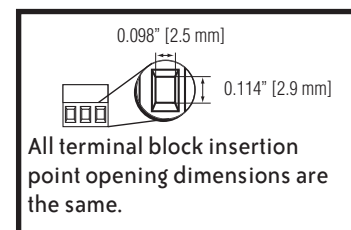
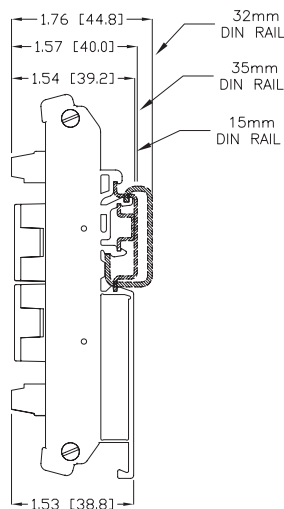
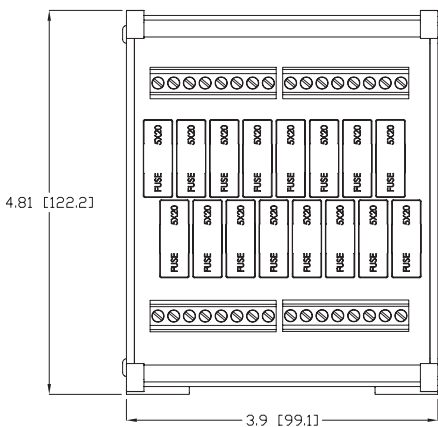

Note: Dimensions shown in Inches [mm]

ZIPLink Specialty Modules Selector				
ZIPLink				
Module	Type	Module Part No.	Cable Part No. (optional)	
24VDC Stand-Alone Relay	Single-Socket Relay	ZL-RLS1-24	N/A	
	Four Socket-Relay	ZL-RLS4-24		
120VAC Stand-Alone Relay	Single-Socket Relay	ZL-RLS1-120		
	Four-Socket Relay	ZL-RLS4-120		
250V AC/DC Max.	16-point, Fused Block	ZL-FUSE-16		
24VDC Transorb	8-Channel	ZL-TSD8-24		
120VAC Transorb	8-Channel	ZL-TSD8-24		
240V AC/DC Max.	40-Point Power/Common	ZL-RTB-COM		
D-Sub Feedthrough	9-pin Male & Female D-Subs to Terminal Blocks	ZL-RTB-DB09		ZL-DB9-CBL-2
	15-pin Male & Female D-Subs to Terminal Blocks	ZL-RTB-DB15		ZL-DB15-CBL-2
	25-pin Male & Female D-Subs to Terminal Blocks	ZL-RTB-DB25	ZL-DB25-CBL-2	
RJ12 Feedthrough	6-pin RJ12 to Terminal Block	ZL-RTB-RJ12	ZL-RJ12-CBL-2	
RJ45 Feedthrough	8-pin RJ45 to Terminal Block	ZL-RTB-RJ45	N/A	
Comm Port Adapters	15-pin HD D-Sub to Terminal Block	ZL-CMA15		
	15-pin HD D-Sub to Terminal Block with LED Indicators	ZL-CMA15L		
Comm Distribution	4-Port RJ12 to Terminal Block	ZL-CDM-RJ12X4		
	10-Port RJ12 to Terminal Block	ZL-CDM-RJ12X10		
Feedthrough Module (SureServo I/O)	50-pin to Terminal Blocks	ZL-RTB50		ZL-SVC-50CBL *

\* Select the cable length by replacing the \* with: Blank = 0.5m, -1 = 1.0m, or -2 = 2.0m

