



STD Series Multi-Wire Connectors Specifications

Technical Characteristics											
Connector Size		3A				10A		16A			
Inserts	Number of Poles		3+PE	4+PE	5+PE	7+PE	12+PE	10+PE	15+PE	16+PE	25+PE
	UL/CSA Rated Voltage*		600V								
	Maximum Rated Current		10A	16A	10A			16A	10A	16A	10A
	EN 61984 (2001-11) Pollution Degree 3	Rated Voltage AC/DC	230/400V			250V	400V	250V			
		Impulse Withstand Voltage	4kV				6kV		4kV		
	EN 61984 (2001-11) Pollution Degree 2	Rated Voltage	230/400V	320/500V	230/400V	400/690V		230/400V			
		Impulse Withstand Voltage	4kV				6kV		4kV		
	Continuous Current Carrying Capacity		Refer to Electrical Engineering section charts								
	Insulation Resistance		10 ¹⁰ Ω								
	Material		Polycarbonate								
	Temperature Range		-40°C to 125°C (-40°F to 257°F)								
	Flammability		UL 94 V-0 GWT 960°								
	Degree Protection	With Housing	IP66, NEMA/UL (Type 1, 4, 4x, 12)								
		Without Housing	IP20								
Mechanical Working Life		500 Cycles									
Conductor Termination	Screw Terminals	√	√	N/A	N/A	N/A	√	N/A	√	N/A	
	Crimp Contacts	N/A	N/A	√	√	√	√	√	√	√	
Contacts	Material		Hard-silver plated (2µm Au) or gold plated copper alloy								
	Minimum Recommended Load (voltage & current)		5V/5mA AC/DC (silver plated)								
	Contact Resistance		≤1 mΩ			≤3 mΩ		≤1 mΩ	≤3 mΩ	≤1 mΩ	≤3 mΩ
	Screw Terminal Wire Size	mm²	0.5-2.5		N/A			0.5-2.5	N/A	0.5-2.5	N/A
		AWG	20-14		N/A			20-14	N/A	20-14	N/A
	Screw Terminal Tightening Test Torque		0.5 Nm		N/A			0.5 Nm	N/A	0.5 Nm	N/A
	Screw Terminal Stripping Length		7.0 mm		N/A			7.0 mm	N/A	7.0 mm	N/A
	Crimp Terminal Wire Size	mm²	N/A	0.5-2.5		0.14-2.5		0.14-4.0	0.14-2.5	0.14-4.0	0.14-2.5
AWG		N/A	26-14			26-12		26-14	26-12	26-14	
Crimp Terminal Stripping Length		N/A	7.5 mm		N/A		7.5 mm	N/A	7.5 mm	N/A	
Thermoplastic Hoods/ Bases/Couplers/Covers	Material		Glass filled polyamide								
	Locking Element		Glass filled polyamide lever and peg								
	Flammability		UL 94 V-0 GWT 960°								
	Housings Seal		NBR (Nitrile rubber)								
	Degree of Protection Acc. to EN 60529 (coupled)		IP66								
	Temperature Range		-40°C to 125°C (-40°F to 257°F)								
	Thread		Metric EN 50262 Pg DIN 40430								
Aluminum Hoods/Bases/ Couplers/Covers	Material		Die cast aluminum alloy, Polyester powder coated								
	Locking Element		Stainless steel lever and peg								
	Housings Seal		NBR (Nitrile)								
	Degree of Protection Acc. to EN 60529 (coupled) NEMA 250, UL50, 50E		IP66, NEMA/UL (Type 1, 4, 4x, 12)								
	Temperature Range		-40°C to 125°C (-40°F to 257°F)								
	Thread		Metric EN50262 Pg DIN 40430								

* Connectors should not be coupled and decoupled under electrical load.

Conductor Termination

Overview

Two types of conductor termination are available for ZIPport inserts:

- Screw terminations
- Crimp terminations

Screw Terminations

Screw terminations consist of contacts made of silver-plated copper alloy and are incorporated with a wire clamp (with the exception of the size 3A inserts and size 24B with 80A contacts) for firmly securing the conductors. The screw terminals use stainless steel captive screws and meet VDE 0609 / EN 60999 standards.

Proper conductor installation requires no special preparation when using inserts with the wire clamp terminals (no wire ferrules). The table below lists the current rating, maximum wire gauge and stripping lengths.

Current Rating	Max Wire Gauge		Stripping Length mm (in)
	mm ²	AWG	
10A	2.5	14	4.5 (0.18)
16A	2.5	14	7 (0.28)
35A	6.0	10	11.5 (0.45)
16/80A	25/16	14/5	7 (0.28)/14 (0.55)

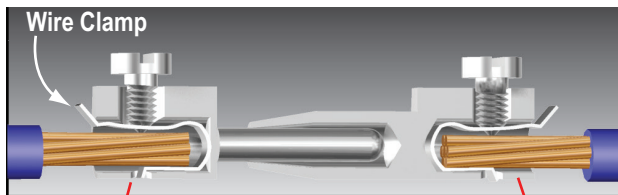

Screw Terminals with Clamps

The value of tensile strength of conductors in accordance with the dimensions of the screws and the wires are shown in the following table:

Wire Gauge mm ² (AWG)	1.5 (16)	2.5 (14)	4 (12)	6 (10)	10 (8)	16 (6)
Size of Screw	M3	M3	M3.5	M4	M4	M6
Tensile Strength of Stranded Wire (N)	40	50	60	80	90	100

Increasing the tightening torque does not necessarily improve the contact resistance. The screw torques are selected according to standard EN 60999-1, to provide excellent mechanical, thermal and electrical behavior. The conductor or terminal may be damaged if the recommended values are significantly exceeded.

Insert Screw Specifications						
Insert Size	Screw Type	Screw Size	Tightening Torque (Nm)	Tightening Torque (in-lbs)	Recommended Screwdriver Size	Recommended Screwdriver Part
3A	10 Amp Terminal	M3	0.25	2.2	0.4 x 2.5	TW-SD-VSL-2
	Installation	M3.5				
	Ground	M3.5				
10A, 16A	16 Amp Terminal	M3	0.50	4.4	0.5 x 3.0	TW-SD-SL-1
	Installation	M4				
	Ground	M4				
6B, 10B	16 Amp Terminal	M3	0.50	4.4	Ph 0-0.8 x 4	TW-SD-VSL-3
	Installation	M4				
	Ground	M4				
16B	35 Amp Terminal	M4	1.2	10.6	Ph 2 1.0 x 5.5	TW-SD-VSL-4
	16 Amp Terminal	M3				
	Installation	M3				
	Ground	M4				
24B	80 Amp Terminal	M6	2.5	22.1	1.0 x 5.5	TW-SD-VSL-4
	16 Amp Terminal	M3				
	Installation	M3				
	Ground	M4				
32B*	16 Amp Terminal	M3	0.50	4.4	Ph 0-0.8 x 4	TW-SD-VSL-3
	Installation	M4				
	Ground	M4				

Note: Size 32B requires 2 size 16B insert

Crimp Terminations

Crimp terminations consist of contacts made of silver or gold-plated copper alloy. Crimp terminations are accomplished by applying a crimp contact to the conductor by means of a crimping tool. Crimp contacts are available in several sizes:

10 amp, 26-14 AWG ; 16 amp, 26-12 AWG

A perfect crimp connection is gas-tight, corrosion free and is equal to a cold weld of the parts being connected. Wires to be connected must be carefully matched with the correct wire size of crimp contacts.

The requirements for crimp connectors are depicted in IEC 60352, part 2.

Note: Low currents and voltages:

ZIPport standard contacts (screw and crimp) have a silver plated surface. This metal has excellent conductive properties. During the contacts's lifetime, the silver surface generates a black oxide layer due to its affinity to sulphur (always present in the atmosphere). This layer is conductive smooth and very thin and is partly interrupted when the contacts are mated and non mated, thus guaranteeing very low contact resistances. In the case of very low current or voltage, small changes to the transmitted signal may be encountered.

In applications where voltage and current are lower than 5V and 5mA, and in extremely aggressive environments, ZIPport gold plated contacts are recommended. See ZIPport spare parts and accessories pages.

Crimp Contact to Insert Installation

Proper installation of the crimp contacts is important for a good electrical and mechanical connection. The following steps will ensure correct installation.

Step 1: Select the Crimp Contacts

Select a crimp contact based on the rating of the Insert you are using - 10 or 16 amps; the gender - male or female; and gauge of wire being used.

Step 2:

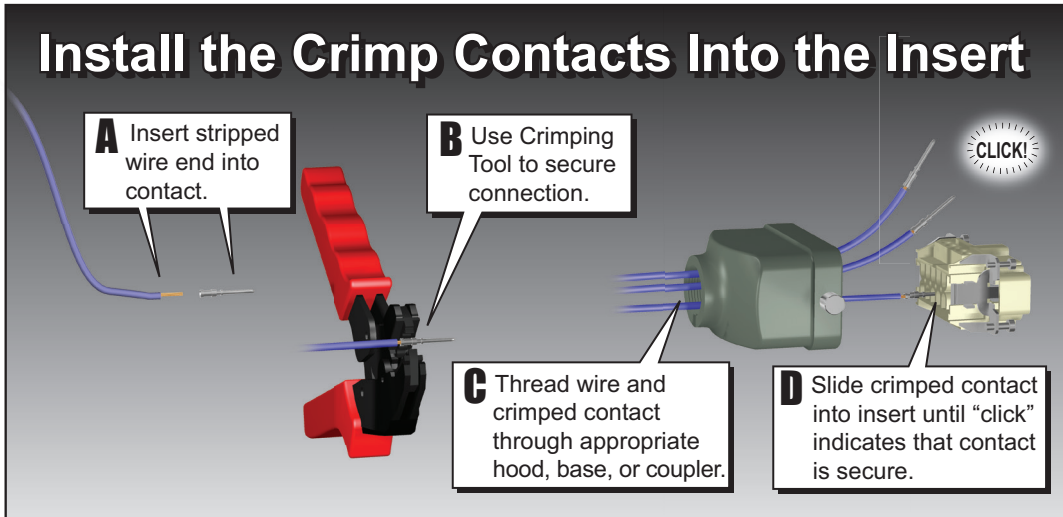

Step 3: Install the Insert into the Housing

Now that the crimp contacts are installed, the insert can be placed into the housing by aligning the corner installation screws of the insert with the screw holes located in the corners of the housing. Tighten the screws according to the tightening torques listed in the Insert Screw Specifications table in this document.

Wire Entry Connection

ZIPports offer four types of connection for wire entry into the housings. Two entries accommodate flex conduit and two accept cable.

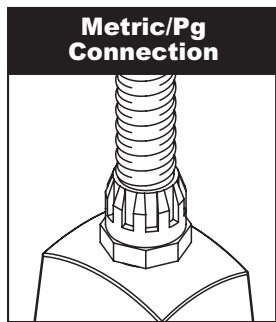

This is standard on all housings that offer a threaded wire entry. Sizes range from Pg 11 to Pg 36. This is for using fittings with a male Pg thread connection.

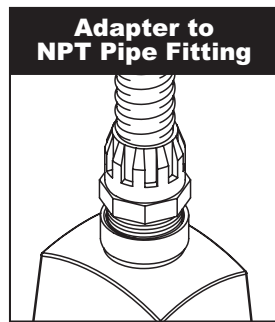

This adapter converts the Pg thread to an NPT thread. Sizes range from 3/8" to 1-1/4" in relation to the Pg threaded opening in the housing.

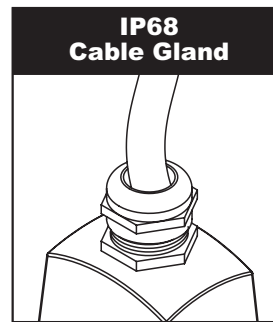

For securing a cable to the housing. This is an all inclusive fitting that can be tightened without using separate washers.

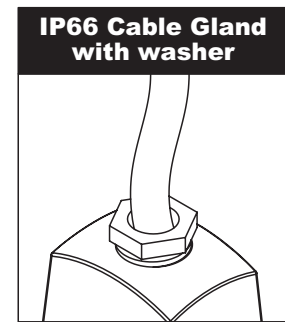

For securing a cable to the housing. This gland is available in plastic or metal in relation to housing material. Includes two washers and four gaskets to accommodate a wide range of cable diameters.



STD Series Multi-Wire Connectors Size 3A



Inserts						
Insert Type	No. of Poles	3+PE	4+PE	5+PE	7+PE	12+PE
	Rated Voltage AC/DC	600V	600V	600V	600V	600V
	Max. Rated Current	10A	10A	16A	10A	10A
	Termination Type	Screw Terminals	Screw Terminals	Crimp Contacts*	Crimp Contacts*	Crimp Contacts*
Male	Part No.	ZP-MC03A-1-MS003	ZP-MC03A-1-MS004	ZP-MC03A-1-MC005	ZP-MC03A-1-MC007	ZP-MC03A-1-MC012
	Price					
	Contact Size	N/A	N/A	ZP-MC-CC-M16A-XX*	ZP-MC-CC-M10A-XX*	ZP-MC-CC-M10A-XX*
	Weight (lb.)	0.284	0.295	0.031	0.163	0.029
Female	Part No.	ZP-MC03A-1-FS003	ZP-MC03A-1-FS004	ZP-MC03A-1-FC005	ZP-MC03A-1-FC007	ZP-MC03A-1-FC012
	Price					
	Contact Size	N/A	N/A	ZP-MC-CC-F16A-XX*	ZP-MC-CC-F10A-XX*	ZP-MC-CC-F10A-XX*
	Weight (lb.)	0.275	0.302	0.031	0.143	0.031

* Crimp Contacts must be purchased separately. The XX represents wire AWG. See Accessories section for complete part numbers.



ZP-MC03A-2-STE11M ZP-MC03A-2-STE11P ZP-MC03A-2-SSE11M ZP-MC03A-2-SSE11P ZP-MC03A-2-SBHM ZP-MC03A-2-SBHP

Hoods, Bases, Couplers and Covers					Accessories***
Housing Component	Threaded Opening**	Part No.	Price	Weight (lb.)	Plug with Gasket
Aluminum	Straight Hood	Pg 11	ZP-MC03A-2-STE11M	0.050	ZP-MC-PLG-11M8
	Angled Hood	Pg 11	ZP-MC03A-2-SSE11M	0.048	ZP-MC-PLG-11M8
	Bulkhead Straight Base	N/A	ZP-MC03A-2-SBHM	0.044	N/A
	Bulkhead Angled Base	N/A	ZP-MC03A-2-SBHAM	0.055	N/A
	Surface Mount Base	Pg 11	ZP-MC03A-2-SSM11M	0.070	ZP-MC-PLG-11M8
	Coupler	Pg 11	ZP-MC03A-2-SCP11M	0.068	ZP-MC-PLG-11M8
	Cover - Male Insert	N/A	ZP-MC03A-2-SCVPMM	0.015	N/A
	Cover - Female Insert	N/A	ZP-MC03A-2-SCVPFM	0.019	N/A
Thermoplastic	Straight Hood	Pg 11	ZP-MC03A-2-STE11P	0.028	N/A
	Angled Hood	Pg 11	ZP-MC03A-2-SSE11P	0.026	
	Bulkhead Straight Base	N/A	ZP-MC03A-2-SBHP	0.024	
	Bulkhead Angled Base	N/A	ZP-MC03A-2-SBHAP	0.030	
	Surface Mount Base	Pg 11	ZP-MC03A-2-SSM11P	0.039	
	Coupler	Pg 11	ZP-MC03A-2-SCP11P	0.033	
	Cover - Male Insert	N/A	ZP-MC03A-2-SCVPPM	0.008	
	Cover - Female Insert	N/A	ZP-MC03A-2-SCVPPF	0.008	

** To convert to NPT, select a Pg to NPT Adapter.

***Accessories pricing and details can be found in the Accessories section.



STD Series Multi-Wire Connectors Size 3A



ZP-MC03A-2-SBHAM



ZP-MC03A-2-SBHAP



ZP-MC03A-2-SSM11M



ZP-MC03A-2-SSM11P



ZP-MC03A-2-SCP11M



ZP-MC03A-2-SCP11P



ZP-MC03A-2-SCVPM



ZP-MC03A-2-SCVPMP



ZP-MC03A-2-SCVPFM



ZP-MC03A-2-SCVFPF



IP66 Cable Gland



IP68 Cable Gland



PG to NPT Adapter



Plug with Gasket

Accessories*** Continued					
Housing Component		IP66 Cable Glands	IP68 Cable Glands	Pg to NPT Adapter	
				Pg 11 to 3/8"	Pg 11 to 1/2"
Aluminum	Straight Hood	ZP-MC-CG-11M5	ZP-MC-CG-11M8	ZP-MC-A-11038	ZP-MC-A-11012
	Angled Hood	ZP-MC-CG-11M5	ZP-MC-CG-11M8	ZP-MC-A-11038	ZP-MC-A-11012
	Bulkhead Straight Base	ZP-MC-CG-11M5	ZP-MC-CG-11M8	ZP-MC-A-11038	ZP-MC-A-11012
	Bulkhead Angled Base	N/A	N/A	N/A	N/A
	Surface Mount Base	ZP-MC-CG-11M5	ZP-MC-CG-11M8	ZP-MC-A-11038	ZP-MC-A-11012
	Coupler	ZP-MC-CG-11M5	ZP-MC-CG-11M8	ZP-MC-A-11038	ZP-MC-A-11012
	Cover - Male Insert	N/A	N/A	N/A	N/A
	Cover - Female Insert	N/A	N/A	N/A	N/A
Thermoplastic	Straight Hood	ZP-MC-CG-11P5	N/A	N/A	N/A
	Angled Hood	ZP-MC-CG-11P5	N/A	N/A	N/A
	Bulkhead Straight Base	ZP-MC-CG-11P5	N/A	N/A	N/A
	Bulkhead Angled Base	N/A	N/A	N/A	N/A
	Surface Mount Base	ZP-MC-CG-11P5	N/A	N/A	N/A
	Coupler	ZP-MC-CG-11P5	N/A	N/A	N/A
	Cover - Male Insert	N/A	N/A	N/A	N/A
	Cover - Female Insert	N/A	N/A	N/A	N/A

*** Accessories pricing and details can be found in the Accessories section.

Electrical Engineering Data - Load Diagrams

Derating diagram According to IEC/EN 60512

These diagrams illustrate the maximum current carrying capacity of components. The illustration follows a curve which shows the current in relation to ambient temperature.

Current carrying capacity is limited by the thermal characteristics of contacts and insulating elements which have an upper temperature limit that should not be exceeded.

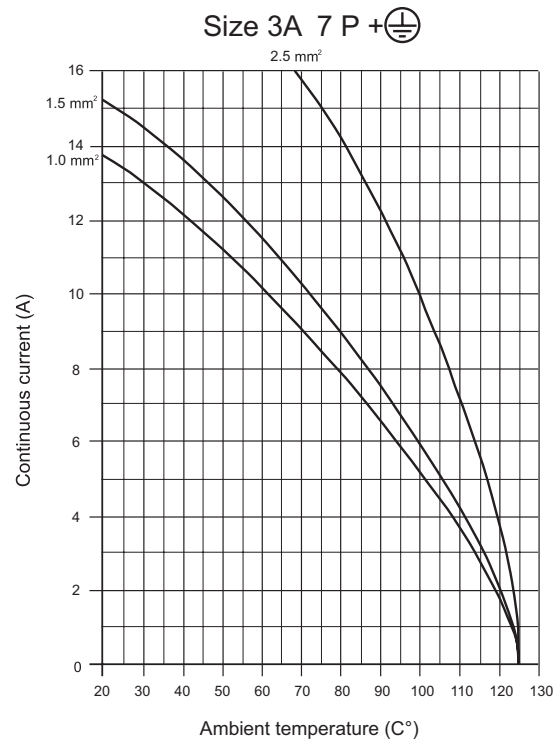
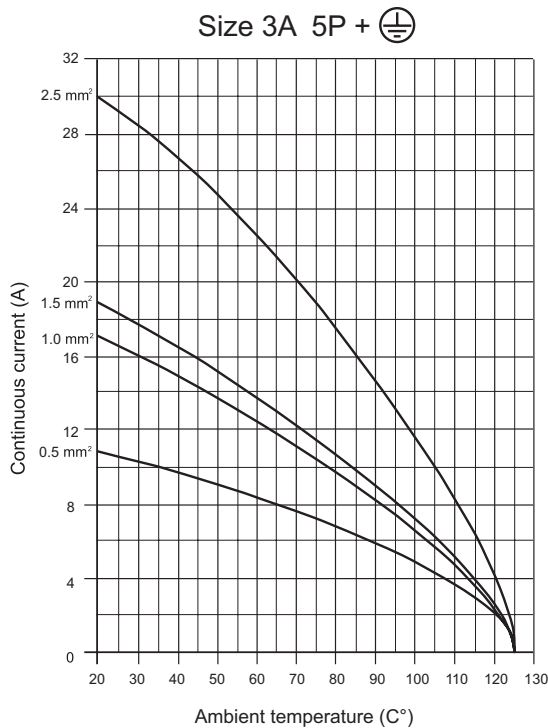
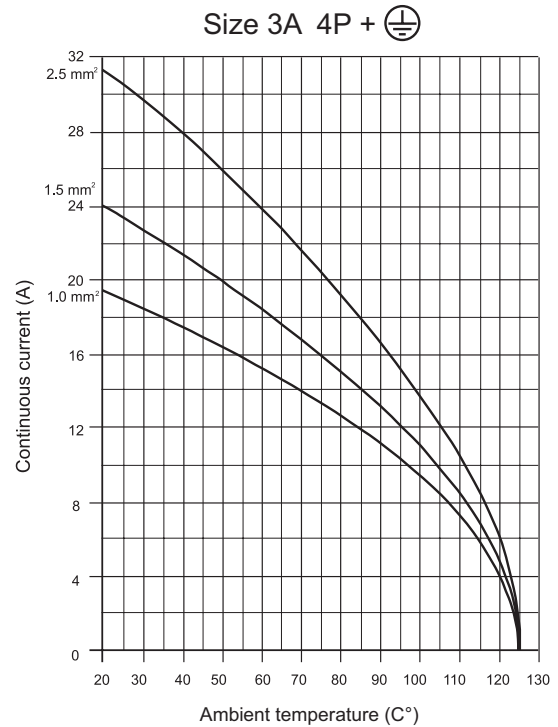
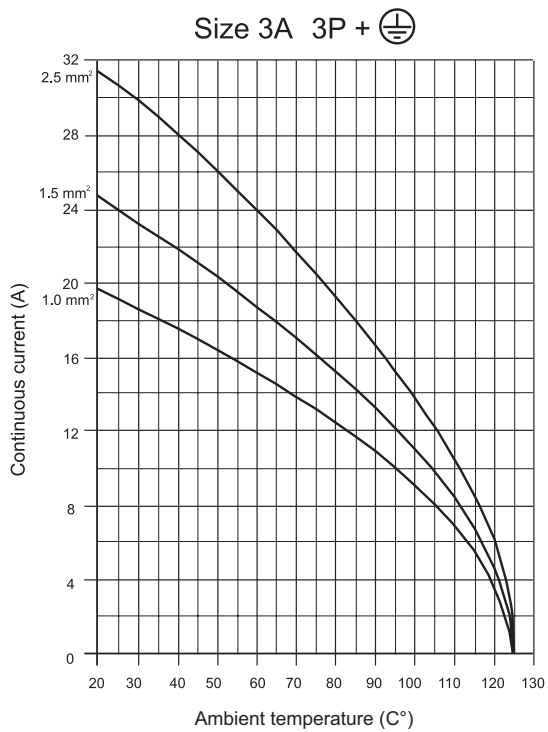



STD Series Multi-Wire Connectors

Electrical Engineering Data - Load Diagrams

Size 3A 12 P + \oplus

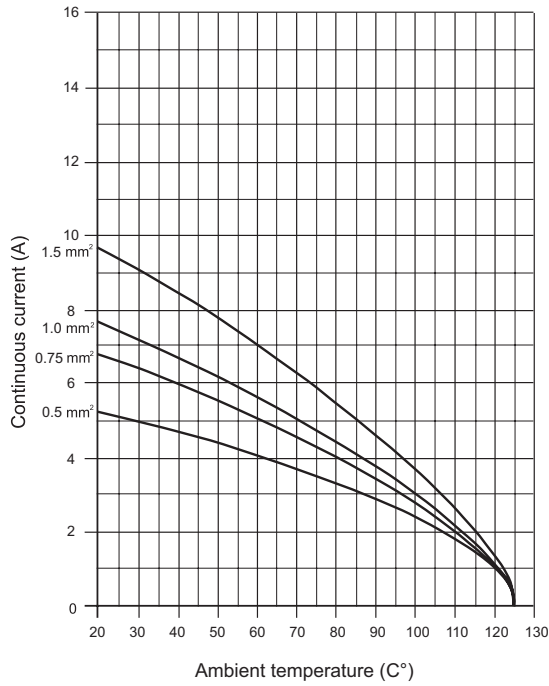

Size 3A Inserts

Dimensions mm [in]

3 + – Screw Terminals

Male

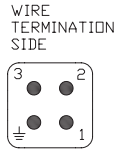
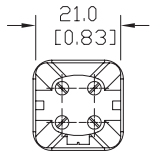

Female

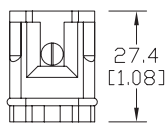
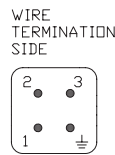
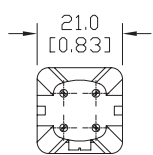

ZP-MC03A-1-MS003

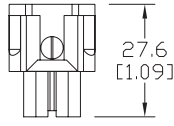

ZP-MC03A-1-FS003

4 + – Screw Terminals

Male

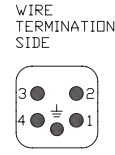
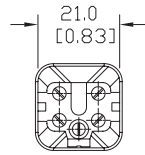

Female

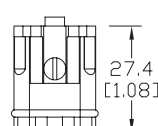
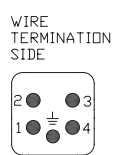
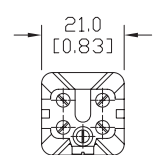

ZP-MC03A-1-MS004

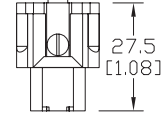

ZP-MC03A-1-FS004

5 + – Crimp Contacts

Male

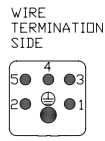
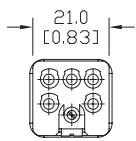

Female

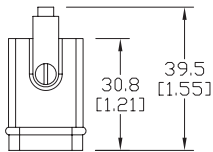
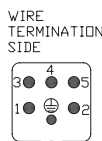
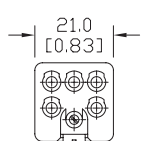

ZP-MC03A-1-MC005

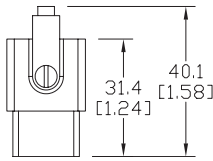

ZP-MC03A-1-FC005

7 + – Crimp Contacts

Male

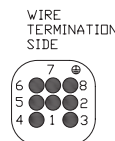
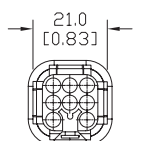

Female

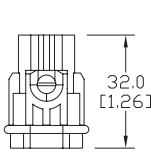
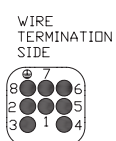
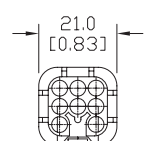

ZP-MC03A-1-MC007

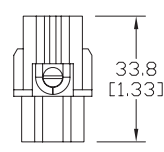

ZP-MC03A-1-FC007

Male

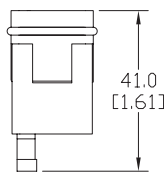
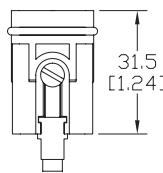

Female

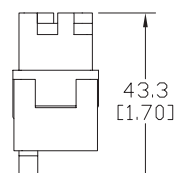
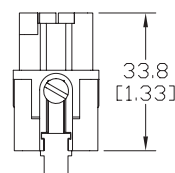

12 + – Crimp Contacts

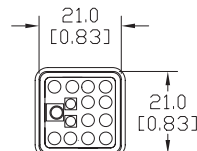
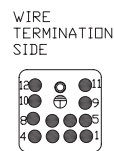

ZP-MC03A-1-MC012

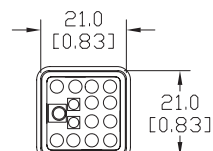
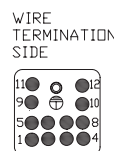

ZP-MC03A-1-FC012



STD Series Multi-Wire Dimensions

Size 3A Hoods and Housings

Dimensions mm [in]

Straight Hood

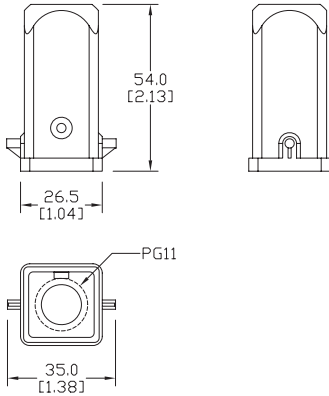

ZP-MC03A-2-STE11M/P

Angled Hood

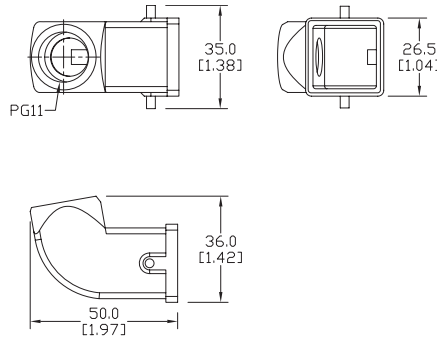

ZP-MC03A-2-SSE11M/P

Bulkhead Straight Base

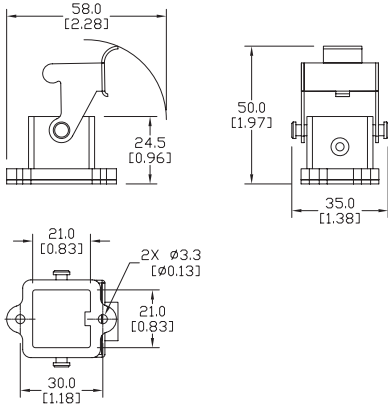

ZP-MC03A-2-SBHM/P

Bulkhead Angled Base

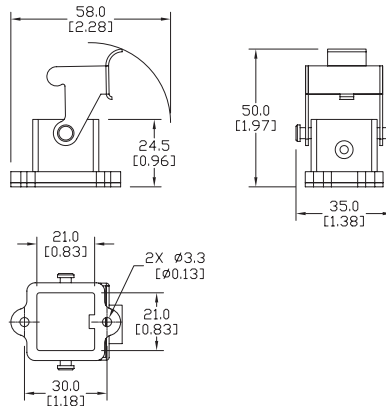

ZP-MC03A-2-SBHAM/P

Surface Mount Base

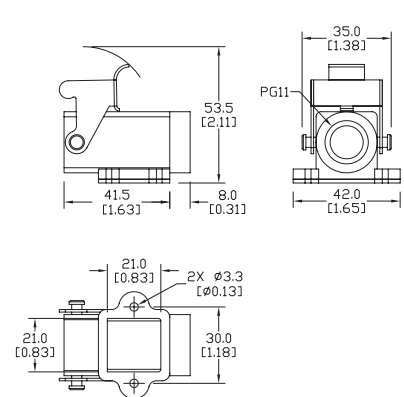

ZP-MC03A-2-SSM11M/P

Coupler

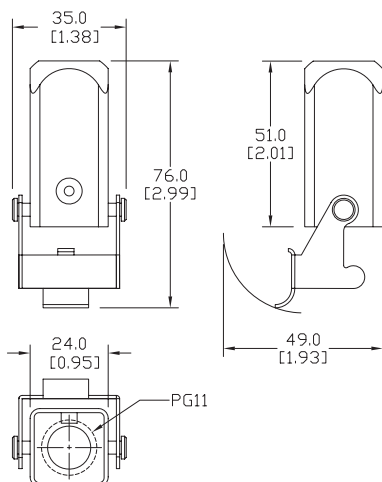

ZP-MC03A-2-SCP11M/P

Cover

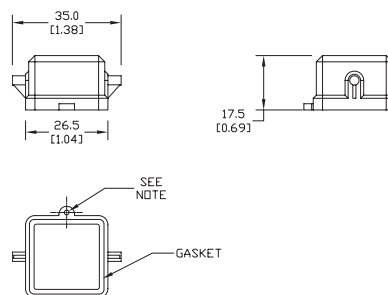

Note: Includes attached 112 mm [4.40 inch] nylon cord with ring terminal

ZP-MC03A-2-SCVPM/P
ZP-MC03A-2-SCVPF/P



STD Series Multi-Wire Connectors

Standards

The inserts are designed and manufactured to conform with EN 61984, (IEC 61984), VDE 0627 and UL 1977/CSA C22.2 182.3 standards. They are certified and labeled with the cULus and CE marks. The connectors are therefore in conformance with both European/International and American systems. This permits them to be used in a wider range of applications worldwide.

- EN 61984 Connectors safety requirements and tests
- VDE 0627 Connectors (DIN VDE 0627)
- EN 60664-1 Insulation coordination for equipment within low-voltage systems
- EN 175 301-801 High density rectangular connectors, round removable crimp contacts
- EN 60947-7-1 part 7-1 Low-voltage switchgear and control gear, Ancillary equipment - Terminal blocks for copper conductors
- VDE 0110 Table 4 concerning clearance and creepage distances
- EN 60512 Connectors for electronic equipment, tests and measurements
- UL 1977 Component connectors for use in data, signal, control and power applications
- CSA.C22.2 No. 182.3 Special use attachment, plugs, receptacles and connectors
- EN 60529 Degree of protection provided by enclosures (IP degree)
- EN 50262 Metric cable glands for electrical installation
- EN 60423 Conduits for electrical purposes. Outside diameters of conduits for electrical installations and thread for conduits and fittings
- ISO 23570-2 Industrial automation system and integration. Distributed installation in industrial applications. Part 2: Hybrid communication bus.
- ISO 23570-3 Industrial automation system and integration. Distributed installation in industrial applications Part 3: Power distribution bus.
- DESINA® specifications Specification to standardize electrical, hydraulic and pneumatic components and their interconnection on a common platform for CNC controlled machine tools and manufacturing lines.

(Distributed and Standardized Installation Technology), Studied by German Manufacturers of Machine Tool Association.

Directives and Declarations

NEMA-250 Declaration of Conformity

Metal and plastic enclosures for Multipole Industrial Connectors (Heavy Duty Connectors). Series STD, STD-HV, HE, HE-HV all sizes. Are designed and manufactured in conformity with NEMA 250-1991 Standard and meet the requirements of NEMA Type 4, 4x and 12.

2006/95/EC: LVD Directive

Directive 2006/95/EC of the European Parliament and of the council of 12 December 2006 on the harmonization of the laws of Members States relating to electrical equipment designed for use within certain voltage limits.

2002/95/EC: RoHS Directive

Directive 2002/95/EC of the European Parliament and of the Council of 27 January 2003 on the restriction of the use of certain hazardous substances in electrical and electronic equipment.

2008/35/EC: RoHS Directive amendment

Directive 2008/35/EC of the European Parliament and of the Council of 11 March 2008 amending Directive 2002/95/EC of the use of certain hazardous substances in electrical and electronic equipment (RoHS) as regards the implementing powers conferred on the Commission.

2004/108/EC EMC Directive

EMC, Electromagnetic Compatibility Directive.

In accordance with the European Directive that regulates the emission and the immunity of the equipment, for the products designed for EMC industrial applications.

Regulation (EC) No 1907/2006 of the European Parliament and of the Council of 18 December 2006 concerning the Registration Evaluation, Authorization and Restriction of Chemicals (REACH), establishing a European Chemicals Agency, amending Directive 1999/45/EC and repealing Council Regulation (EEC) No 793/93 and Commission Regulation (EC) No 1488/94 as well as Council Directive 76/769/EEC and Commission Directives 91/155/EEC, 93/67/EEC, 93/105/EEC and 2000/21/EC.



WARNING - ACCORDING TO EN 61984, CONNECTORS SHOULD NOT BE COUPLED AND DECOUPLED UNDER ELECTRICAL LOAD.



Type 1/4/4x/12

Crimp Contact Basic Assembly

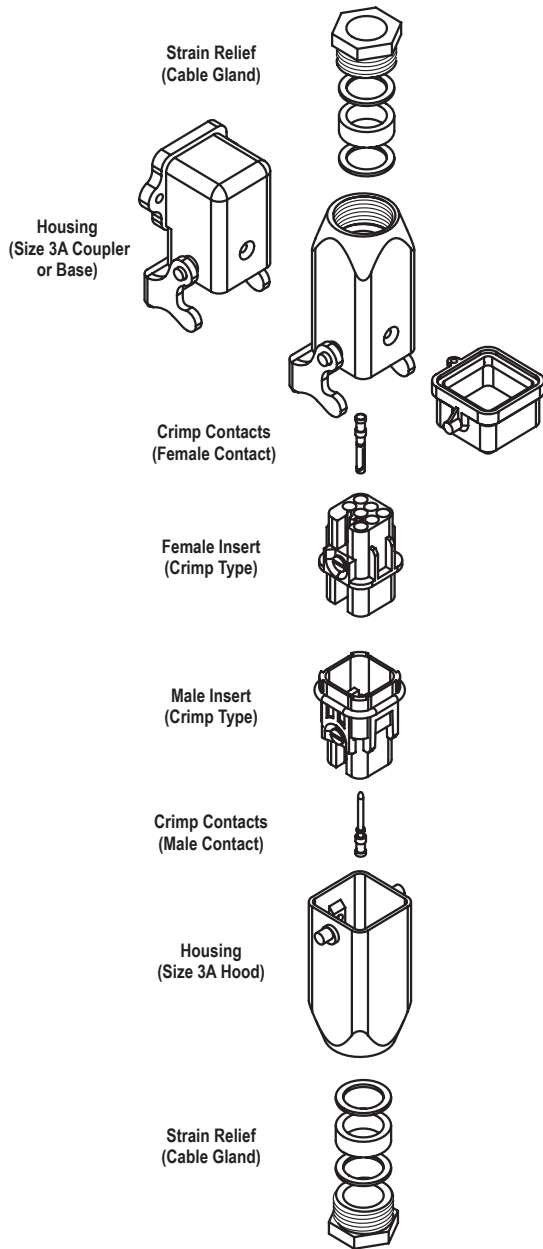

Screw Terminal Basic Assembly

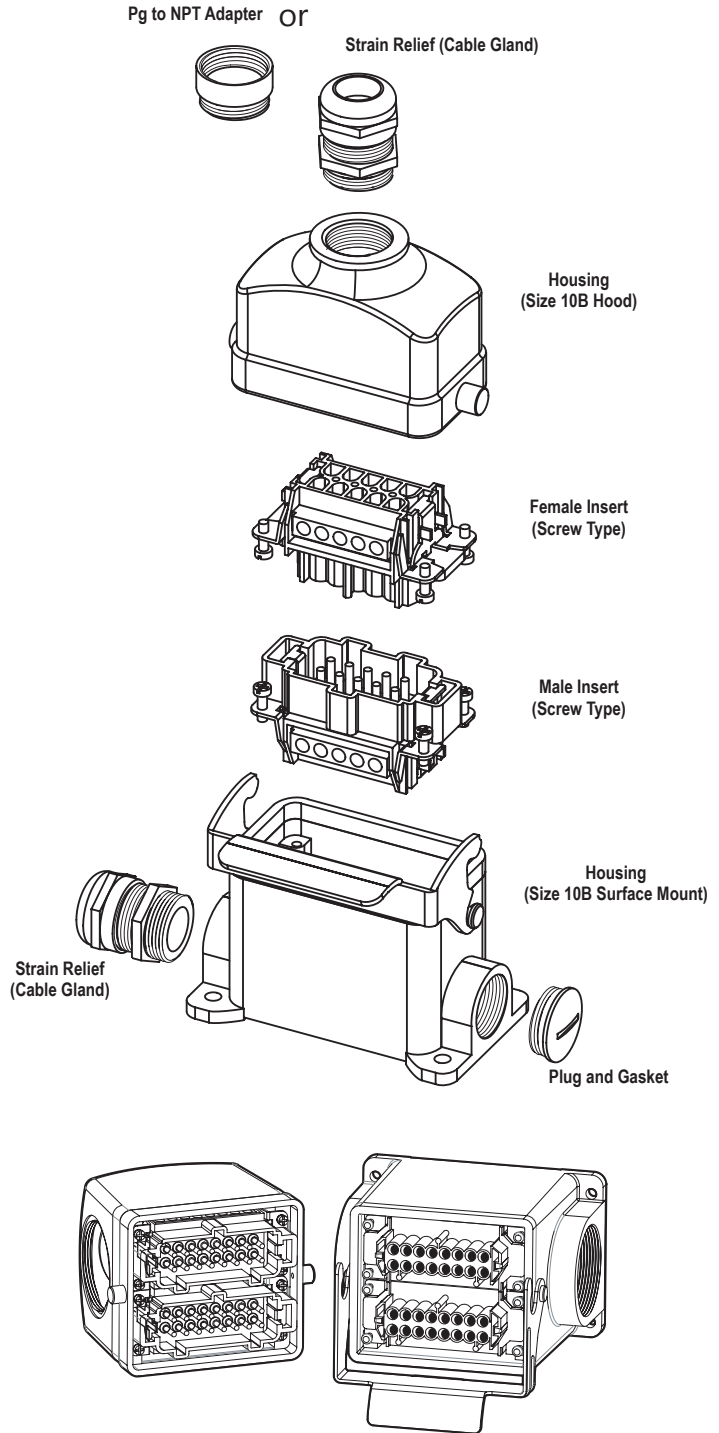



STD Series Multi-Wire Connectors Spare Parts and Accessories

Crimp Contacts - 10 and 16 Amp

Crimp contacts are made of hard silver-plated or gold-plated copper alloy. Wires to be connected must be carefully matched with the correct wire size of crimp contacts. Crimp contacts should be installed using a crimping tool. For applications with voltages and currents lower than 5V and 5mA gold plated contacts are recommended.

10 Amp Crimp Contacts - 100/Pack								
	Male	Price	Weight (lb.)	Female	Price	Weight (lb.)	Wire Gauge mm ² [AWG]	Stripping Length
Silver-Plated	ZP-MC-CC-M10A-22		0.150	ZP-MC-CC-F10A-22		0.150	0.14-0.37 [26-22]	8 mm [0.32 in]
	ZP-MC-CC-M10A-20		0.150	ZP-MC-CC-F10A-20		0.140	0.5 [20]	
	ZP-MC-CC-M10A-18		0.150	ZP-MC-CC-F10A-18		0.150	0.75 [18]	
	ZP-MC-CC-M10A-16		0.150	ZP-MC-CC-F10A-16		0.140	1.5 [16]	
	ZP-MC-CC-M10A-14		0.140	ZP-MC-CC-F10A-14		0.150	2.5 [14]	
Gold-Plated	ZP-MC-CC-M10A-22G		0.157	ZP-MC-CC-F10A-22G		0.159	0.14-0.37 [26-22]	
	ZP-MC-CC-M10A-20G		0.150	ZP-MC-CC-F10A-20G		0.157	0.5 [20]	
	ZP-MC-CC-M10A-18G		0.146	ZP-MC-CC-F10A-18G		0.150	0.75 [18]	
	ZP-MC-CC-M10A-16G		0.146	ZP-MC-CC-F10A-16G		0.150	1.5 [16]	
	ZP-MC-CC-M10A-14G		0.146	ZP-MC-CC-F10A-14G		0.152	2.5 [14]	



Male Crimp Contact



Female Crimp Contact



Male Crimp Contact



Female Crimp Contact

16 Amp Crimp Contacts - 100/Pack								
	Male	Price	Weight (lb.)	Female	Price	Weight (lb.)	Wire Gauge mm ² [AWG]	Stripping Length
Silver-Plated	ZP-MC-CC-M16A-22		0.280	ZP-MC-CC-F16A-22		0.280	0.14-0.37 [26-22]	7.5 mm [0.29 in]
	ZP-MC-CC-M16A-20		0.360	ZP-MC-CC-F16A-20		0.350	0.5 [20]	
	ZP-MC-CC-M16A-18		0.270	ZP-MC-CC-F16A-18		0.290	0.75 [18]	
	ZP-MC-CC-M16A-16		0.350	ZP-MC-CC-F16A-16		0.350	1.5 [16]	
	ZP-MC-CC-M16A-14		0.270	ZP-MC-CC-F16A-14		0.280	2.5 [14]	
	ZP-MC-CC-M16A-12		0.350	ZP-MC-CC-F16A-12		0.350	4.0 [12]	
Gold-Plated	ZP-MC-CC-M16A-22G		0.280	ZP-MC-CC-F16A-22G		0.322	0.14-0.37 [26-22]	
	ZP-MC-CC-M16A-20G		0.276	ZP-MC-CC-F16A-20G		0.318	0.5 [20]	
	ZP-MC-CC-M16A-18G		0.273	ZP-MC-CC-F16A-18G		0.315	0.75 [18]	
	ZP-MC-CC-M16A-16G		0.273	ZP-MC-CC-F16A-16G		0.320	1.5 [16]	
	ZP-MC-CC-M16A-14G		0.276	ZP-MC-CC-F16A-14G		0.320	2.5 [14]	
	ZP-MC-CC-M16A-12G		0.273	ZP-MC-CC-F16A-12G		0.329	4.0 [12]	

Note: The crimp contact ampacities listed above are the Maximum current ratings for the crimp contacts only. The current rating DOES NOT reflect the wire gauge current rating.

Crimp Contact Tools				
Part Number	Price	Qty.	Description	Weight (lb.)
ZP-MC-CT1		1	Crimping tool w/die set and locator	1.593
ZP-MC-CT2			Crimping tool w/die set only, no locator	0.814
ZP-MC-RT1			Removal tool for 10A contacts	0.081
ZP-MC-RT2			Removal tool for 16A contacts	0.086



ZP-MC-CT1



ZP-MC-CT2



ZP-MC-RT1



ZP-MC-RT2



STD Series Multi-Wire Connectors Spare Parts and Accessories

Cable Glands

IP66 Glands

Plastic

- Thread: 1.5 mm pitch in accordance with EN 50262, Pg in accordance with DIN 40430
- IP Protection: IP66 in accordance with EN 60529
- Working Temperature: -40°C to 125°C (-40°F to 257°F)
- Materials: Body - Glass filled polyamide UL 94 V0; Washer - zinc plated steel; Gasket - Elastomer
- Includes two washers and four gaskets to accommodate a wide range of cable diameters
- Applications: for size 3A plastic type housings

Metal

- Thread: 1.5 mm pitch in accordance with EN 50262, Pg in accordance with DIN 40430
- IP Protection: IP66 in accordance with EN 60529
- Working Temperature: -40°C to 125°C (-40°F to 257°F)
- Materials: Body - nickel-plated brass; Washer - zinc plated steel; Gasket - Elastomer
- Includes two washers and four gaskets to accommodate a wide range of cable diameters
- Applications: for all sizes metal type housings

IP68 Glands

Metal

- Thread: 1.5 mm pitch in accordance with EN 50262, Pg in accordance with DIN 40430
- IP Protection: IP68, patented design for up to 5 bars
- Working Temperature: -40°C to 125°C (-40°F to 257°F)
- Materials: Body - nickel-plated brass; Strain relief - Glass filled polyamide UL 94 V0; Gasket - Elastomer
- Applications: for industrial connector housings where higher protection and strength are required

IP66 Cable Glands						
Part Number	Price	Qty.	Type	Cable Diameter mm [in]	Thread	Weight (lb.)
ZP-MC-CG-11P5		1	Plastic	7-12 [0.275-0.472]	Pg 11	0.019
ZP-MC-CG-11M5				7-12 [0.275-0.472]	Pg 11	0.030
ZP-MC-CG-13M5			Metal	7-12 [0.275-0.472]	Pg 13.5	0.031
ZP-MC-CG-16M5				7-14.5 [0.275-0.570]	Pg 16	0.041
ZP-MC-CG-21M5				9.5-18.5 [0.374-0.728]	Pg 21	0.070
ZP-MC-CG-29M5				17.5-26.5 [0.688-1.043]	Pg 29	0.125
ZP-MC-CG-36M5				23.5-32.5 [0.925-1.279]	Pg 36	0.249

Note: IP66 cable glands with washers CANNOT be used with HC (High Construction) top or side entry housings.
You must use the IP68 cable glands. IP66 glands can be used with surface mount HC (High Construction) housings



IP66 Cable Glands - Plastic



IP66 Cable Glands - Metal



IP68 Cable Glands

IP68 Cable Glands						
Part Number	Price	Qty.	Type	Thread	Diameter mm [in]	Weight (lb.)
ZP-MC-CG-11M8		10 per pack	Metal	Pg 11	4-10 [0.157-0.393]	0.451
ZP-MC-CG-13M8				Pg 13.5	5-12 [0.197-0.472]	0.780
ZP-MC-CG-16M8				Pg 16	8-14 [0.314-0.551]	0.881
ZP-MC-CG-21M8		5 per pack		Pg 21	11-18 [0.433-0.708]	0.727
ZP-MC-CG-29M8				Pg 29	16-25 [0.629-0.984]	1.466
ZP-MC-CG-36M8				Pg 36	19-36 [0.748-1.417]	2.205



STD Series Multi-Wire Connectors Spare Parts and Accessories

Blanking Plugs with Gasket

- Thread: 1.5 mm pitch in accordance with EN 50262, Pg in accordance with DIN 40430
- IP Protection: IP68 in accordance with EN 60529
- Working Temperature: -40°C to 125°C (-40°F to 257°F)
- Materials: Body - nickel-plated brass; Gasket - Elastomer
- Applications: for blanking threaded holes on housings or other enclosures

Blanking Plugs With Gasket					
Part Number	Price	Qty.	Type	Thread	Weight (lb.)
ZP-MC-PLG-11M8		10 per pack	Metal	Pg 11	0.169
ZP-MC-PLG-13M8				Pg 13.5	0.192
ZP-MC-PLG-16M8				Pg 16	0.253
ZP-MC-PLG-21M8				Pg 21	0.478
ZP-MC-PLG-29M8		5 per pack		Pg 29	0.218
ZP-MC-PLG-36M8				Pg 36	0.706



Blanking Plugs With Gasket

Pg to NPT Adapters

Thread: Metric 1.5 mm pitch Pg in accordance with DIN 40430, NPT in accordance with USAS B2-1

- IP Protection: dependant on coupling and other components
- Working Temperature: -60°C to 200°C (-76°F to 392°F)
- Materials: nickel-plated brass
- Applications: for converting a Pg thread to an NPT thread

Pg to NPT Adapters						
Part Number	Price	Qty.	Type	Pg Thread	NPT Thread	Weight (lb.)
ZP-MC-A-11038		1	Metal	Pg 11	3/8"	0.044
ZP-MC-A-11012				Pg 11	1/2"	0.072
ZP-MC-A-13012				Pg 13.5	1/2"	0.106
ZP-MC-A-16012				Pg 16	1/2"	0.070
ZP-MC-A-21034				Pg 21	3/4"	0.101
ZP-MC-A-29100				Pg 29	1"	0.194
ZP-MC-A-29114				Pg 29	1 1/4"	0.238
ZP-MC-A-36114				Pg 36	1 1/4"	0.201



Pg to NPT Adapters

Replacement Gaskets

Replacement Gaskets						
Part Number	Price	Qty.	Size	Type	Material	Weight (lb.)
ZP-MC03A-GSK		10 per pack	3A	For bulkhead housings	Nitrile Butadiene Rubber (NBR)	0.085
ZP-MC10A-GSK			10A			0.082
ZP-MC16A-GSK			16A			0.079
ZP-MC06B-GSK			6B			0.097
ZP-MC10B-GSK			10B			0.105
ZP-MC16B-GSK			16B			0.127
ZP-MC24B-GSK			24B			0.141
ZP-MC32B-GSK			32B			0.229



Replacement Gaskets



STD Series Multi-Wire Connectors Spare Parts and Accessories

Insert Plates with Cutouts

Insert Plates with Cutouts				
Part Number	Price	Qty.	Description	Weight (lb.)
ZP-MC6B-2-1XDB9		1	ZIPport insert plate, (1) 9-pin D-sub connector cutout(s), thermoplastic, RAL 7044 gray. For use with ZIPport size 6B connector housing.	0.0176
ZP-MC6B-2-2XDB9			ZIPport insert plate, (2) 9-pin D-sub connector cutout(s), thermoplastic, RAL 7044 gray. For use with ZIPport size 6B connector housing.	0.0154
ZP-MC6B-2-1XDB15			ZIPport insert plate, (1) 15-pin D-sub connector cutout(s), thermoplastic, RAL 7044 gray. For use with ZIPport size 6B connector housing.	0.0176
ZP-MC6B-2-2XDB15			ZIPport insert plate, (2) 15-pin D-sub connector cutout(s), thermoplastic, RAL 7044 gray. For use with ZIPport size 6B connector housing.	0.0154

Note: machine screw M3-0.5x16 hardware not included



Insert Plates with Cutouts

Bulkhead Cutout Reducing Plates

Bulkhead Cutout Reducing Plates				
Part Number	Price	Qty.	Description	Weight (lb.)
ZP-MC24B-2-RD6B		1	ZIPport bulkhead cutout reducing plate, thermoplastic, RAL 7044 gray. For use with ZIPport size 24B bulkhead cutouts. Gasket included. Reduces cutout to ZIPport size 6B.	0.0838
ZP-MC24B-2-RD10B			ZIPport bulkhead cutout reducing plate, thermoplastic, RAL 7044 gray. For use with ZIPport size 24B bulkhead cutouts. Gasket included. Reduces cutout to ZIPport size 10B.	0.0816
ZP-MC24B-2-RD16B			ZIPport bulkhead cutout reducing plate, thermoplastic, RAL 7044 gray. For use with ZIPport size 24B bulkhead cutouts. Gasket included. Reduces cutout to ZIPport size 16B.	0.0772



Bulkhead Cutout Reducing Plates

Bulkhead Cutout Blank Covers

Bulkhead Cutout Blank Covers				
Part Number	Price	Qty.	Description	Weight (lb.)
ZP-MC6B-2-BLANK		1	ZIPport bulkhead cutout blank cover plate, thermoplastic, RAL 7044 gray. For use with ZIPport size 6B bulkhead cutouts. Gasket included.	0.4343
ZP-MC10B-2-BLANK			ZIPport bulkhead cutout blank cover plate, thermoplastic, RAL 7044 gray. For use with ZIPport size 10B bulkhead cutouts. Gasket included.	0.0463
ZP-MC16B-2-BLANK			ZIPport bulkhead cutout blank cover plate, thermoplastic, RAL 7044 gray. For use with ZIPport size 16B bulkhead cutouts. Gasket included.	0.0529
ZP-MC24B-2-BLANK			ZIPport bulkhead cutout blank cover plate, thermoplastic, RAL 7044 gray. For use with ZIPport size 24B bulkhead cutouts. Gasket included.	0.0573



Bulkhead Cutout Blank Covers



STD Series Multi-Wire Connectors Spare Parts and Accessories

DIN Rail Mounting Kits

- For mounting inserts inside an enclosure
- Fits 35 mm DIN rail

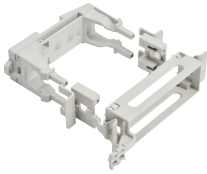

DIN Rail
Mounting Kits



ZP-MC-RT3

DIN Rail Mounting Kits				
Part Number	Price	Qty.	Description	Weight (lb.)
<u>ZP-MC06B-DKIT</u>		1	For size 6B inserts	0.374
<u>ZP-MC10B-DKIT</u>			For size 10B inserts	0.377
<u>ZP-MC16B-DKIT</u>			For size 16B inserts	0.385
<u>ZP-MC24B-DKIT</u>			For size 24B inserts	0.392
<u>ZP-MC-RT3</u>			Insert removal tool	0.052

Replacement Screws/Polarization Key

Replacement Screws / Polarization Key				
Part Number	Price	Qty.	Description	Weight (lb.)
<u>ZP-MC-SCRWKIT</u>		2 pieces of each part	M3.5 - PE screw for size 3A inserts	0.048
			M4 - PE screw for size 6B insert, size 10B insert, size 16B insert (16+PE) and size 24B insert (24+PE)	
			M4 - PE screw for size 16B insert (6+PE) and size 24B insert (8+4+PE)	
			M3 - Installation screw for 3A inserts only	
			M3 - Installation screw for all inserts except 3A	
<u>ZP-MC-POLKEY-1</u>		12	Polarization key for size 3A 12-pin inserts. Two keys are required per coupled connection.	0.011



Polarization
Key

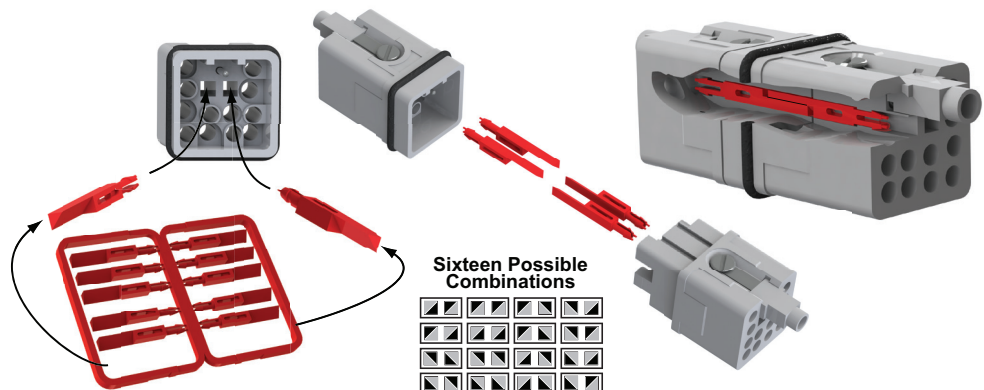

Using the Polarization Key



STD Series Multi-Wire Connectors Spare Parts and Accessories

Code Pins					
Part Number	Price	Qty.	Description	Figure	Weight (lb.)
<u>ZP-MC-CODEPIN-2</u>		16 per pack	Single code pin	1	0.009
<u>ZP-MC-CODEPIN-3</u>		16 per pack	Male code pin (use w/ZP-MC-CODEPIN-4)	2	0.064
<u>ZP-MC-CODEPIN-4</u>		16 per pack	Female code pin (use w/ZP-MC-CODEPIN-3)	3	0.101

* Code pins are used in applications where there are identical connectors that could be coupled with the incorrect mate, potentially causing equipment damage or breakdown. Code pins replace the installation screws on the inserts. Code pins do NOT work with 3A inserts or 32x13 inserts. The following combinations of code pins allow for a selective number of couples. Material is zinc-plated steel.

Coding Pin Configurations

Single Code Pin

The ZP-MC-CODEPIN-2 is designed to be used as a single stand-alone code pin using the following configurations.



Figure 1

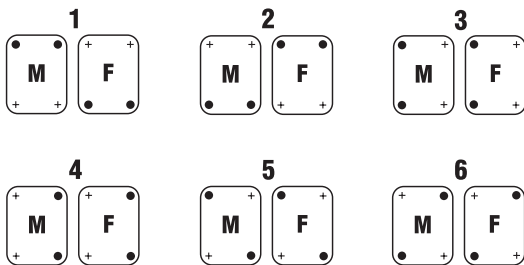

Figure 2



Figure 3

Application with single insert



- Code pin ZP-MC-CODEPIN-2
- + Normal fixing screw
- M** Male insert
- F** Female insert

Application with double insert

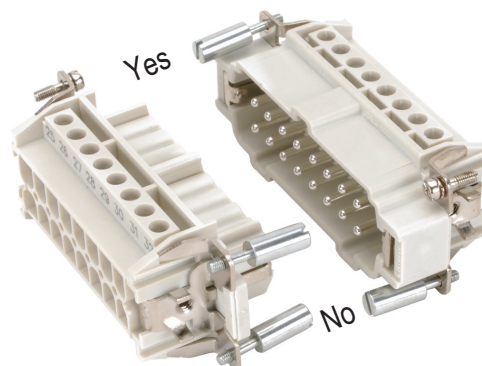
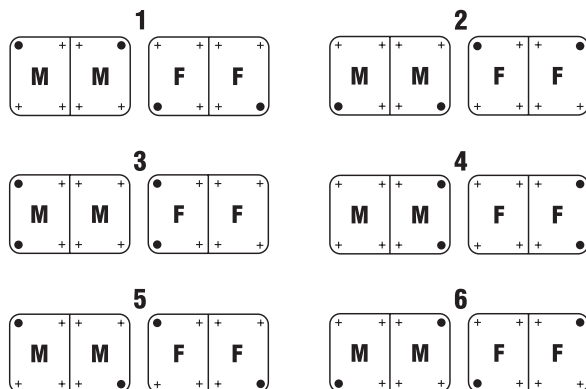

STD Series Multi-Wire Connectors Spare Parts and Accessories

Coding Pin Configurations

Male / Female Code Pins

The ZP-MC-CODEPIN-3 and the ZP-MC-CODEPIN-4 are designed to be used together using the following configurations.

Application with single insert

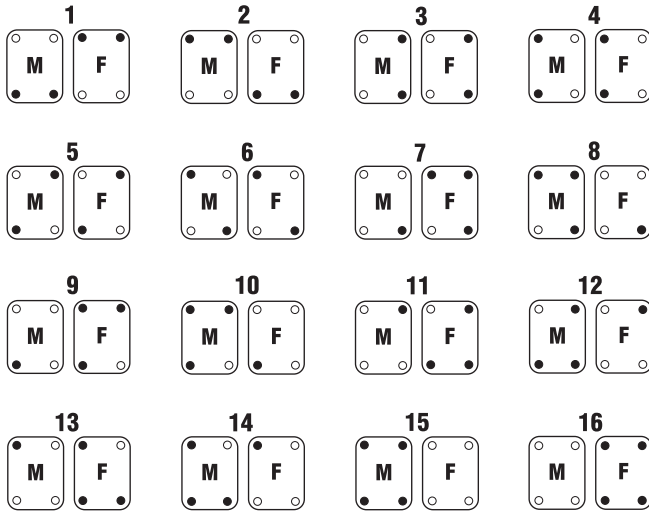

Application with double insert

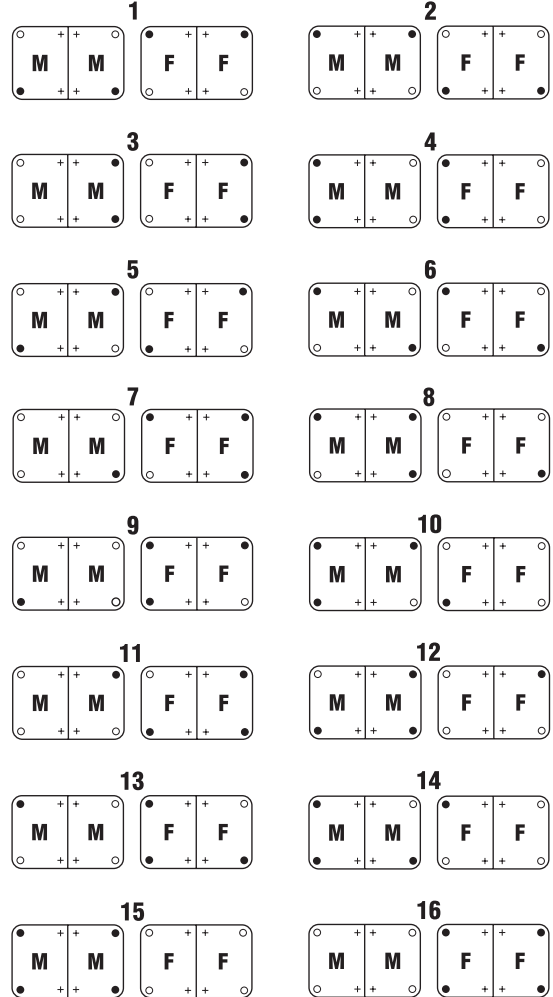

- Male code pin ZP-MC-CODEPIN-3
- Female code pin ZP-MC-CODEPIN-4
- + Normal fixing screw
- M** Male insert
- F** Female insert

