

# CONTROL TECHNIQUES



# PUMP DRIVE F600

SIMPLE, RELIABLE FLOW CONTROL  
SPECIALIST DRIVE

**DRIVE OBSESSED**

# PUMP DRIVE F600

# THE SPECIALIST

# PUMP DRIVE

From the drive specialists

Applications involving the flow of water demand extreme reliability and low energy consumption. Control Techniques' F600 drive, part of the newly introduced Specialist series of industry-specific drive technologies, builds on our company's five decades of drives expertise, delivering precise, dependable flow control.

Everything you need is baked into the drive itself. The F600 packs all of the features you'll need, presented using terminology you'll understand. This isn't a generic drive with pump features tacked on; it's a dedicated, specialist pump drive, designed from the ground up to deliver the reliability and efficiency you need.

## Free 5 year warranty

To share our confidence in the reliability of Control Techniques, drives in the F600 range are eligible for Control Techniques' extended warranty, at no extra cost.

It is a testament to our exceptional track record for reliability, giving you total peace of mind that your investment is protected and your site will continue to run uninterrupted.

Warranty terms and conditions apply.



## The perfect mix of application-specific features developed into a single solution



### Speaks your language

The F600 drive is tuned to suit your every need, optimised for minimal setup time yet sacrificing none of the flexibility. Whatever the challenge, our dedicated approach to clear parameter naming and structuring ensures we not only have the answers, but in a format you'll understand.



### Energy savings, unlocking the potential

On average, 85% of a pump's life-cycle cost is attributed to its energy consumption, therefore, optimising the energy usage can mean a significant reduction in the total cost of ownership. The F600 drive thrives on delivering more efficient ways of operating your variable torque application. You'll see the benefits in reduced running costs and lower energy requirements.



### Engineered for your application

The F600 Pump Drive offers a host of dedicated features including dry-run prevention, pipe fill, pump cleaning, over-cycling protection and level switch control. A range of different control modes covering single pumps and also different parallel pump configurations make Control Techniques' F600 a truly versatile solution.



### Total control

The F600 can also control the most efficient motors available, meeting IE5 efficiency levels, such as the Nidec Leroy Somer Dyneo+ hybrid permanent-magnet motor. With all of this combined, the F600 is your best choice to save you money every day.

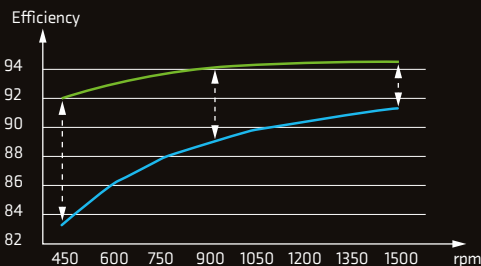
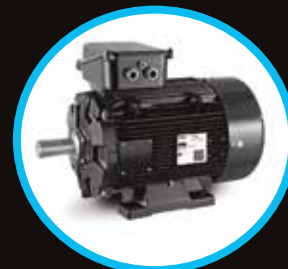

● AC PMA SynRM Dyneo+

● AC IE2 IM with VSD

# PIONEERING GROUNDWATER SPRINKLER SYSTEM DEPENDS ON ADVANCED DRIVES

Domina Inn and Conference Centre, located in Rotterdam, features a pioneering sprinkler system that uses groundwater pumped up from a sand layer 60 metres underground. Control Techniques AC drives were chosen to power the main and back-up pumps, due to the 'Fire' mode they offer, guaranteeing uninterrupted emergency operation.

# UNMATCHED TOTAL COST OF OWNERSHIP

With innovative protective features and extended equipment life

The F600 has comprehensive pump and motor protection features which minimise unplanned downtime, improving overall effectiveness and guaranteeing better value for money. Bring true resilience to your application and easily ride-through component failures.

## Automatic Error Recovery

In the unlikely event of detecting an error with your pump, the F600 has the ability to dynamically recover and resume normal operation.

## Limit Protection

If the feedback exceeds the limits defined for your application, the F600 has the ability to raise an alarm or stop the drive to protect your equipment and preserve its lifetime.

## Transducer Loss Protection

In the event of losing connection to the transducer, the F600 can stop, continue to run at a fixed speed or ignore the fault depending on the application requirements.

## Fire mode

Fire mode allows the drive to disable all trips and to continue to run uninterrupted during emergency events if the application requires.

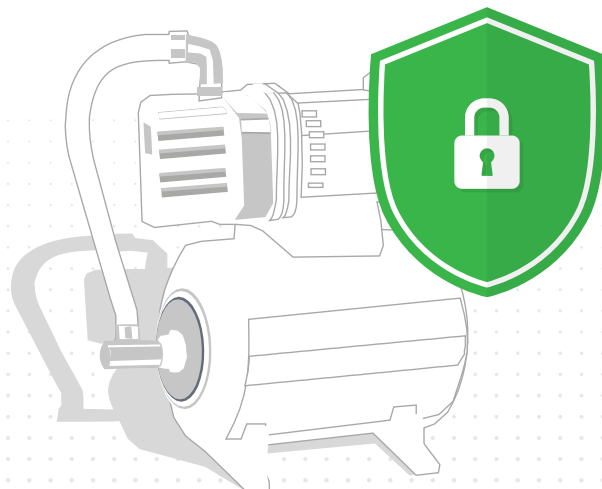

# SAVE ON ENERGY THROUGH A WIDE RANGE OF ENERGY FEATURES

**The F600 is 98% efficient, meaning very little energy is lost in power conversion.**

Even more, the real savings potential gets unlocked by the F600's built-in features that can further reduce energy consumption:

## Low load savings

The F600 helps maximise energy savings when demand is low. Activating Control Techniques' leading-edge Low Load Power Saving function, the drive dynamically reduces the voltage applied to reduce losses in the motor and make the system more efficient.

## Sleep mode

When demand falls below a specified set-point the drive will automatically enter sleep mode and restart itself once demand rises above the set-point. Not only does this greatly reduce the amount of energy consumed, it also saves on equipment wear to preserve its lifetime.

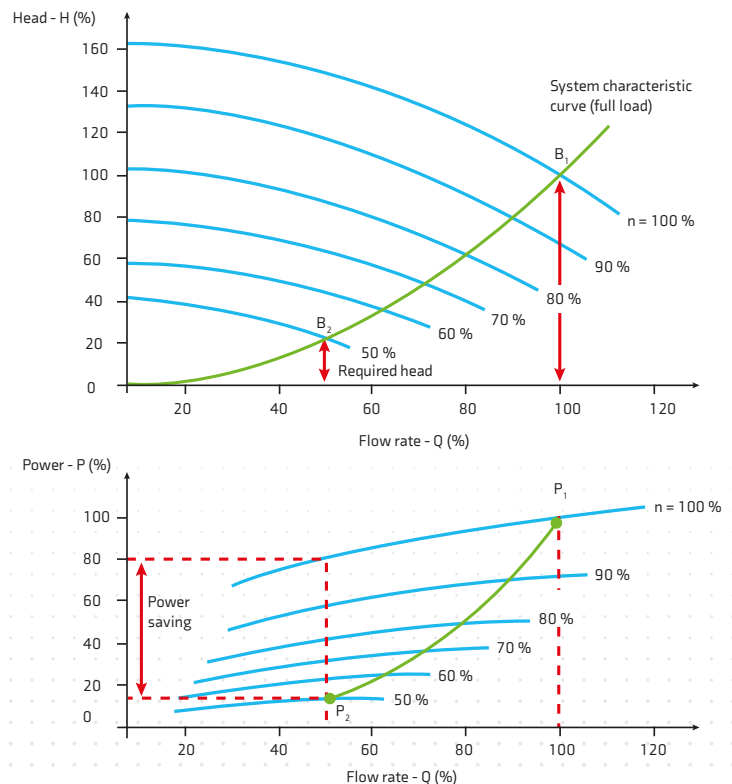



## Drives provide unique cost-saving solution in the water industry

Byzak Limited, a Framework Contractor to Northumbrian Water, worked with Control Techniques to solve the problem of pump blockages at Seaton Sluice, near Whitley Bay, UK

## The F600 features optimised control for your flow applications

### Pipe fill

Prevent spikes in pressure at start-up using a controlled ramp, to protect your piping system and the pump itself.

### Over-cycling protection

Optimise drive, motor and pump sizing, and regulate pump wear by limiting the number of start-stops per hour. Flexible configurations allow to dynamically alter cycling reference limits, set an alarm or stop the drive when a limit is reached.

### Cleaning

Live, continuous monitoring of the system is used to trigger an automatic drive-based cleansing cycle to clear the pump impeller and help avoid maintenance costs on cleaning pump blockages.

### Dry-run prevention

Prevent the pump running dry by checking the load against a threshold; with flexible configurations to dynamically adjust output, set an alarm or stop the drive.

### No-flow detection

Where there is no-flow or low-flow, the F600 drive can automatically enter sleep mode to save energy, based on the feedback of a pulsed flow transducer, or triggered by a flow switch, or detected by the software alone.

### Level switch control

Level switches provide critical protection for tanks in the event of the level reaching a “high” switch, whereby the pump is stopped, or a “low” switch, whereby the pump is started, to ensure pumping within tank levels.

# PUMP CONTROL MODES

# FLEXIBLE SUPPORT

# FOR EVERY SYSTEM

## Single pump

Control Techniques' Single Pump mode is an effective and versatile variable speed control solution for maintaining a constant set-point in a single pump configuration.

- Fire mode allows the drive to disable all trips and to continue to run uninterrupted during emergency events if the application requires

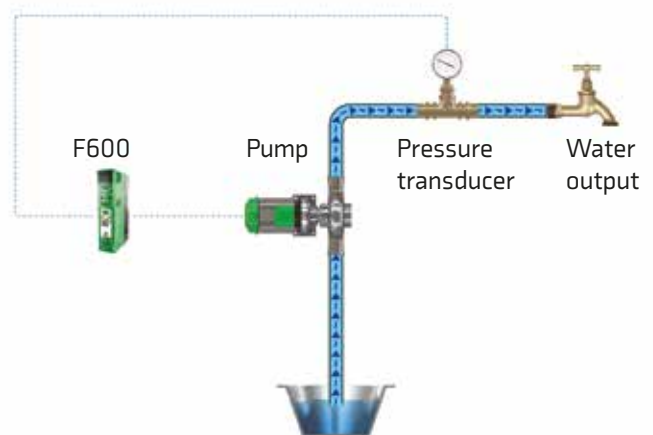

## Cascade

Cascade mode allows the F600 to operate with up to 2 assist pumps to aid the primary pump when required.

- Energy usage is optimised whereby the assist pumps are only enabled when demand reaches sufficient levels.
- Assist pumps are used alternately to apply uniform wear and increase pump availability.
- Over-cycling protection for assist pumps to control the number of starts and stops per hour.

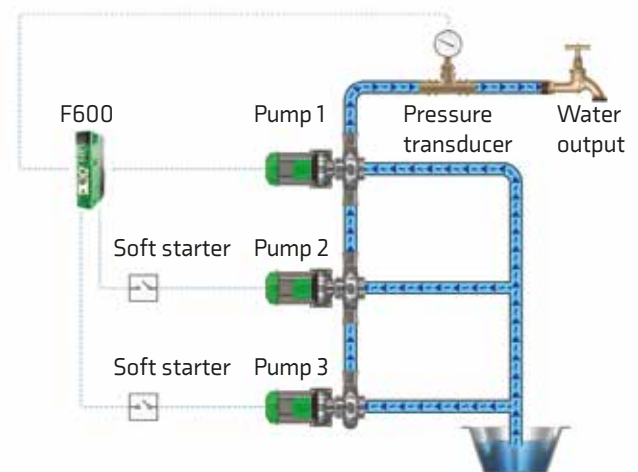





### Multi-leader

Complete control of your application with up to 3 x F600 drives and maximum energy savings with these variable frequency drives running parallel.

- The Multi-leader drive configuration provides redundancy and removes the need for a PLC
- The “lead” drive is automatically cycled to apply uniform wear
- If the “lead” drive loses its transducer, it can access the transducer feedback from another F600 in the system over Ethernet
- Dynamic re-selection of “lead” pump if a pump is taken out of service or develops a fault

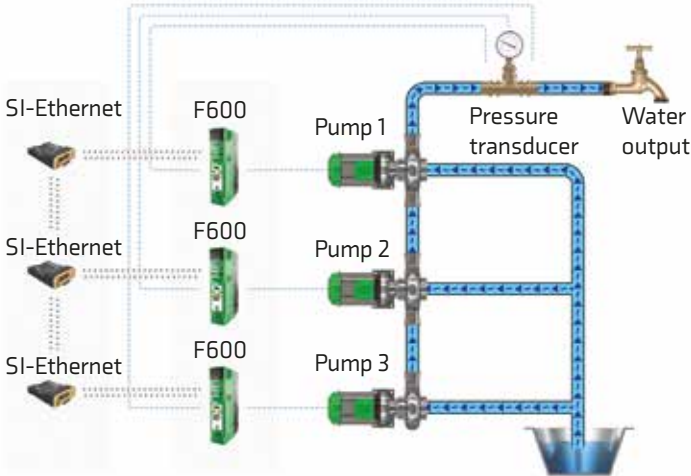

# SIMPLE COMMISSIONING FOR HASSLE-FREE, EFFICIENT INSTALLATION

**Install and go. Application-focused design and dedicated pump functions mean optimum performance can be achieved straight out of the box, with minimal set-up.**

## Guided Commissioning Tool

Gain complete control of your drive with Control Techniques' Connect PC Software. The dedicated Pump Drive setup screens guide you through every step of quickly getting your drive up and running.

Everything is covered in a simple, logical format, from configuring your multi-pump system, through the input of motor characteristics, to setting up the PID process control loop. All the pump features are also readily available, providing intuitive setup with contextual help through a single tool.

## Single setup menu

Setup using only the keypad couldn't be easier. There's no need to waste time looking for all the parameters - we've grouped them all together for you in one, streamlined menu.

All relevant parameters are literally at your fingertips to easily configure and monitor your application.

All additional parameters are still accessible through the advanced menus, for un-precedented control and finetuning.



Guided setup screen within the Connect PC software

# FREE STANDING DRIVE RANGE

Ready to use pre-engineered high power drives

## Highly efficient pre-engineered motor control system

Control Techniques' Free Standing Drive optimises motor energy efficiency and comes ready to use, pre-assembled in its own industry-standard cabinet with all necessary system components included. The Pump Drive F600's Free Standing Drive variant complements and extends the product range, while having all of the core product's capabilities and features.

## No extra engineering required

The Free Standing Drive fits a small footprint, and it's easy to integrate with common cubicles, including as standard: load switch, fuses, fan, line and sharing chokes and cabling. The cabinet can also come with a door-mounted HMI with Real-Time Clock, for easy set-up and maintenance.

Thanks to the dedicated online configurator, getting a quote and ordering is as simple as can be. Even more, we can ship your Free Standing Drive to you at very short lead times, saving weeks on typical industry standards.

## Light weight, but no light weight!

The F600 is also available with Control Techniques' largest frame, which not only offers 500 kW of power in a single module, but at 130 kg is up to 60 kg lighter than competitor drives. Its small footprint and pre-engineered accessories make it easy to install or retrofit in industry-standard cubicles.



Large frame power module in pre-assembled cabinet



# CONTROL TECHNIQUES PC TOOLS

## Energy savings estimation

Control Techniques' energy optimisation software helps you analyse energy usage for flow applications and quantify the cost savings of using your Control Techniques drive.

- Estimation of energy usage using Control Techniques variable frequency drives for pump applications
- Identify the payback period through the energy savings from using a Pump Drive F600 over conventional control methods
- Graphical representation of flow versus cost, hours and time

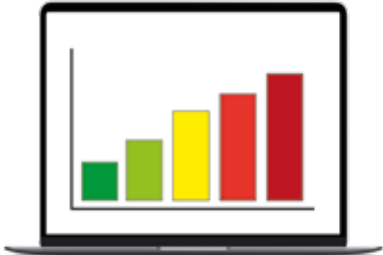

## Diagnostic Tool

The Diagnostic Tool App is a fast and simple tool, which allows users to quickly solve any error codes that the drive may show. Built within the app are easy to locate wiring diagrams for first time setup and fault finding with links to the relevant comprehensive manuals.

The app also has full contact details of the technical support teams around the world to aid you with technical assistance.

Available for iOS, Android and Windows™, download the app for free at [www.controltechniques.com/mobile-applications](http://www.controltechniques.com/mobile-applications)



\*For Microsoft users, please note that this mobile app operates with Windows 10 only.

Slot for Smartcard/SD card for parameter storage and cloning

Easy click-in keypad connector

Multi-language LCD keypad

With Hand, Off and Auto controls and built-in real-time clock for run time scheduling

3x System Integration (SI) module slots for communications and I/O\*\*

Onboard I/O

- |                    |                                 |
|--------------------|---------------------------------|
| 2 x analog inputs  | 3 x configurable digital I/O    |
| 2 x analog outputs | 2 x form C relay outputs        |
| 3 x digital inputs | 1 x Safe Torque Off (STO) input |

\*\*SI-I/O option provides additional 4 x digital I/O, 3 x analog inputs (default)/digital inputs, 1 x analog output (default)/digital input, 2 x relays

User-friendly pluggable control connections



\*Features and their locations vary on some drive sizes

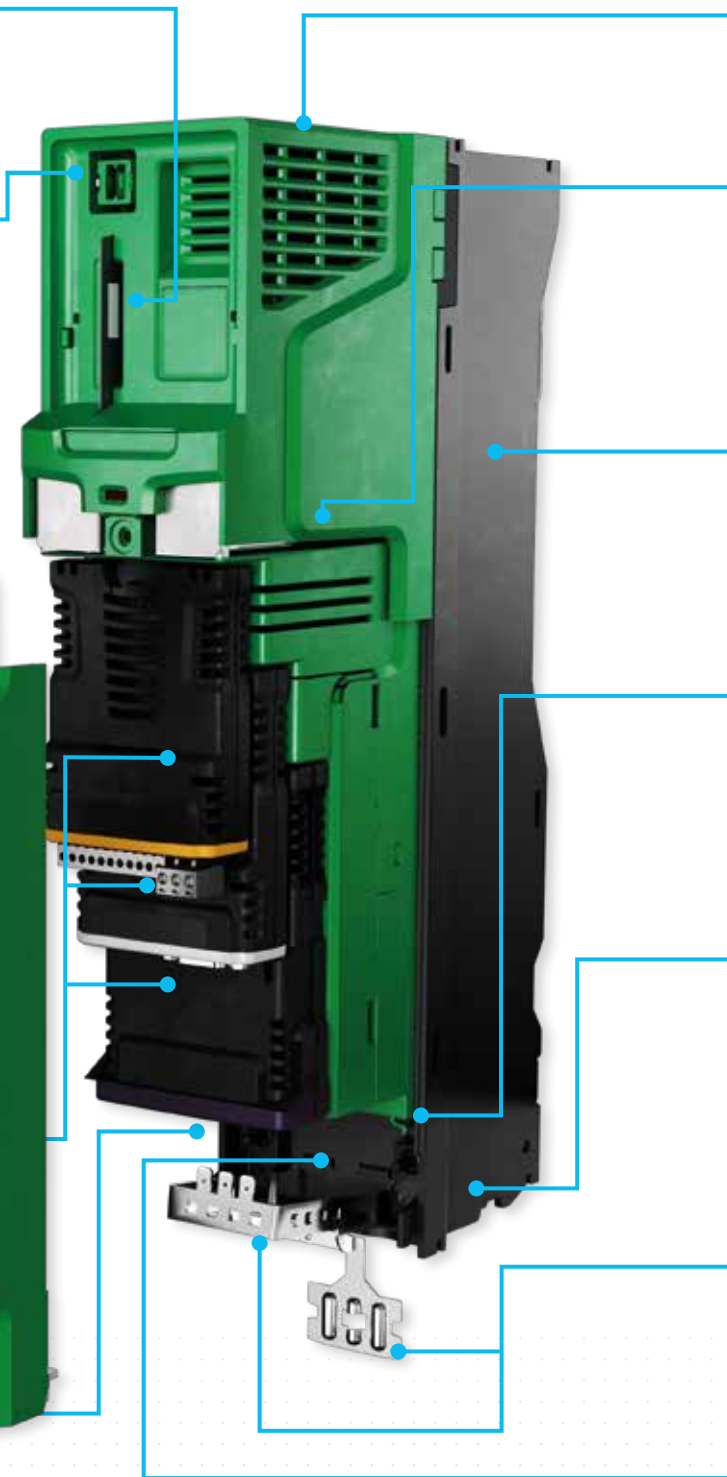

**Onboard EMC filter\***

**Conformal coating as standard**

**Aluminium chassis**

Allows flexible mounting, with high performance extruded heatsink.

**User-friendly power connections**

With removable terminals\*.

**Adaptive multi-speed fan control**

The fan can also be replaced by the user after installation

**Robust cable management system**

Grounding point for shielded control and power cables

**3-pin RS485 Modbus communications as standard**

## Pump Drive F600 ratings guide

200/240 Vac ±10%			
Drive	Max continuous current (A)	Normal Duty	
		Motor shaft power (kW)	Motor shaft power (hp)
F600-03200066A10	6.6	1.1	1.5
F600-03200080A10	8	1.5	2
F600-03200110A10	11	2.2	3
F600-03200127A10	12.7	3	3
F600-04200180A10	18	4	5
F600-04200250A10	25	5.5	7.5
F600-05200300A10	30	7.5	10
F600-06200500A10	50	11	15
F600-06200580A10	58	15	20
F600-07200750A10	75	18.5	25
F600-07200940A10	94	22	30
F600-07201170A10	117	30	40
F600-08201490A10	149	37	50
F600-08201800A10	180	45	60
F600-09202160A10	216	55	75
F600-09202660A10	266	75	100
F600-09202160E10	216	55	75
F600-09202660E10	266	75	100
F600-10203250E10	325	90	125
F600-10203600E10	360	110	150

380/480 Vac ±10%			
Drive	Max continuous current (A)	Normal Duty	
		Motor shaft power (kW)	Motor shaft power (hp)
F600-03400034A10	3.4	1.1	1.5
F600-03400045A10	4.5	1.5	2
F600-03400062A10	6.2	2.2	3
F600-03400077A10	7.7	3	5
F600-03400104A10	10.4	4	5
F600-03400123A10	12.3	5.5	7.5
F600-04400185A10	18.5	7.5	10
F600-04400240A10	24	11	15
F600-05400300A10	30	15	20
F600-06400380A10	38	18.5	25
F600-06400480A10	48	22	30
F600-06400630A10	63	30	40
F600-07400790A10	79	37	50
F600-07400940A10	94	45	60
F600-07401120A10	112	55	75
F600-08401550A10	155	75	100
F600-08401840A10	184	90	125
F600-09402210A10	221	110	150
F600-09402660A10	266	132	200
F600-09402210E10	221	110	150
F600-09402660E10	266	132	200
F600-10403200E10	320	160	250
F600-10403610E10	361	200	300
F600-11404370E10	437	225	350
F600-11404870E10	487	250	400
F600-11405070E10	507	280	450

### Manuals

F600 is supplied with a Step-by-Step Setup Guide to assist with fast, efficient commissioning. A detailed user guide is also available to download online, or can be requested from Control Techniques Drive Centres and Partners.



380/480 Vac ±10%			
Drive	Max continuous current (A)	Normal Duty	
		Motor shaft power (kW)	Motor shaft power (hp)
F600-12404800TU0	608	315	500
F600-12405660TU0	660	355	550
F600-12406600TU0	755	400	650
F600-12407200TU0	865	500	700

500/575 Vac ±10%			
Drive	Max continuous current (A)	Normal Duty	
		Motor shaft power (kW)	Motor shaft power (hp)
F600-05500039A10	3.9	2.2	3
F600-05500061A10	6.1	4	5
F600-05500100A10	10	5.5	7.5
F600-06500120A10	12	7.5	10
F600-06500170A10	17	11	15
F600-06500220A10	22	15	20
F600-06500270A10	27	18.5	25
F600-06500340A10	34	22	30
F600-06500430A10	43	30	40
F600-07500530A10	53	37	50
F600-07500730A10	73	45	60
F600-08500860A10	86	55	75
F600-08501080A10	108	75	100
F600-09501250A10	125	90	125
F600-09501550A10	155	110	150
F600-09501250E10	125	90	125
F600-09501500E10	150	110	150
F600-10502000E10	200	130	200
F600-11502480E10	248	175	250
F600-11502880E10	288	225	300
F600-11503150E10	315	250	350

500/690 Vac ±10%			
Drive	Max continuous current (A)	Normal Duty	
		Motor shaft power (kW)	Motor shaft power (hp)
F600-07600230A10	23	18.5	25
F600-07600300A10	30	22	30
F600-07600360A10	36	30	40
F600-07600460A10	46	37	50
F600-07600520A10	52	45	60
F600-07600730A10	73	55	75
F600-08600860A10	86	75	100
F600-08601080A10	108	90	125
F600-09601250A10	125	110	150
F600-09601500A10	150	132	175
F600-09601250E10	125	110	150
F600-09601550E10	155	132	175
F600-10601720E10	172	160	200
F600-10601970E10	197	185	250
F600-11602250E10	225	200	250
F600-11602750E10	275	250	300
F600-11603050E10	305	280	400

### Drive reference F600

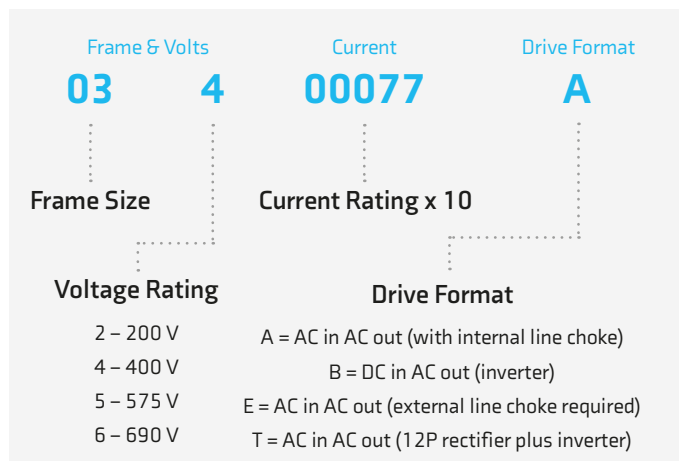

## Comprehensive options for flexibility

Keypad type		Description
KI-HOA Keypad RTC (Supplied as standard*)		The KI-HOA Keypad RTC provides Hand-Off-Auto control. The display presents up to four lines of real text with multi-language translation, enhancing clarity and increasing ease of use. A battery operated real-time clock allows scheduling of run and off periods and adds accurate time stamping to diagnostics to aid rapid fault resolution
Remote HOA Keypad RTC		Remote mountable keypad, allowing flexible mounting on the outside of a panel (meets IP54/NEMA 12). The keypad offers Hand-Off-Auto control and can present up to four lines of real text with multi-language translation, enhancing clarity and increasing ease of use. Battery operated real-time clock allows scheduling of run and off periods and adds accurate time stamping to logged events, aiding diagnostics
KI-485 Adaptor		This adaptor can be fit in place of the drive keypad and provides additional ports to communicate via RS485. The adaptor is commonly used for programming the drive.
System Integration Modules - Communications		
SI-Ethernet		External Ethernet module that supports EtherNet/IP and Modbus TCP/IP and has an integrated web server that can generate emails. The module can be used to provide high speed drive access, global connectivity and integration with IT network technologies, such as wireless networking. To use multiple F600 drives in Multi-leader mode in a parallel pump system, each F600 drive must have an SI-Ethernet module fitted.
SI-EtherCAT		SI-EtherCAT allows F600 to connect and interface with EtherCAT networks.
SI-PROFINET		SI-PROFINET allows F600 to communicate and interface with PROFINET PLCs and networks.
SI-PROFIBUS		PROFIBUS interface module PROFIBUS-DP (Decentralized Peripheral) interface module enables follower connectivity. It is possible to use more than one SI-PROFIBUS or a combination of SI-PROFIBUS and other option modules to add additional functionality such as extended I/O, gateway functionality, or additional PLC features
SI-DeviceNet		DeviceNet networking system interface module enables follower connectivity. It is possible to use more than one SI-DeviceNet or a combination of SI-DeviceNet and other option modules to provide additional functionality such as extended I/O, gateway functionality, or additional PLC features
SI-CANopen		CANopen interface module supporting various profiles, including several drive profiles
SI-Applications Plus		Second processor module, which allows SyPTPro application programs to be re-compiled for F600
MCI200		Second processor, providing advanced customisation using standard IEC61131-3 programming languages
Additional I/O and NV media cards		
SI-I/O		Extended I/O interface module to increase the number of I/O points on a drive. Provides additional: 4 x Digital I/O, 3 x Analog inputs (default)/Digital inputs, 1 x Analog output (default)/Digital input, 2 x Relays
Smartcard		The optional Smartcard memory device can be used to back-up parameter sets, as well as copying them from one drive to another
SD Card Adaptor		Conversion device that allows an SD card to be inserted into the Smartcard slot, for parameter cloning and application programs

\*For higher cost efficiency, F600 can be supplied without a keypad. Please specify your preference when ordering.

## Normal duty operation only

Suitable for pump applications, with a current overload requirement of 110% for 60 s\*.

## Conformance

- IP20 / NEMA1 / UL TYPE 1 \*UL open class as standard, additional kit needed to achieve Type 1
- IP65 / NEMA4 / UL TYPE 12 rating is achieved on the rear of the drive when through panel mounted
- \*Frame size 9D, 9E, 10D and 10E achieve IP55 / NEMA 4 / UL Type 12
- Ambient temperature -20 °C to 40 °C (-4 °F to 104 °F) as standard. Up to 55 °C (131 °F) with derating
- Humidity 95 % maximum (non-condensing) at 40 °C (104 °F)
- Altitude: 0 to 3000 m (9900 ft), derate 1 % per 100 m (330 ft) between 1000 m (3300 ft) and 3000 m (9900 ft)
- Random Vibration Tested in accordance with IEC 60068-2-64
- Bump Tested in accordance with IEC 60068-2-29
- Sinusoidal Vibration Tested in accordance with IEC 60068-2-6
- Mechanical Shock Tested in accordance with IEC 60068-2-29
- Storage temperature -40 °C to 55 °C (-40 °F to 131 °F) or up to 70 °C (158 °F) for short-term storage
- Electromagnetic Immunity complies with EN 61800-3 and EN 61000-6-2
- With onboard EMC filter, emissions comply with EN 61800-3 (category C3)
- EN 61000-6-3 and EN 61000-6-4 with optional footprint EMC filter
- IEC 60146-1-1 Supply conditions (category C1 or C2 depending on rating)
- IEC 61800-5-1 (Electrical Safety)
- IEC 61131-2 I/O
- EN 61000-3-12 with optional line reactor
- UL 508C (Electrical Safety)

## Keypads

Description	Order code
KI-HOA Keypad RTC F600	82400000018500
Remote HOA Keypad RTC	82400000019700
KI-485 Adaptor	82400000016100

## Dimensions



Frame size	Dimensions		Weight
	mm (HxWxD)	in (HxWxD)	kg (lb)
3	382 x 83 x 200	15.0 x 3.3 x 7.9	4.5 (9.9)
4	391 x 124 x 200	15.4 x 4.9 x 7.9	6.5 (14.3)
5	391 x 143 x 200	15.4 x 5.6 x 7.6	7.4 (16.3)
6	391 x 210 x 227	15.4 x 8.3 x 8.9	14 (30.9)
7	557 x 270 x 280	21.9 x 10.6 x 11.0	28 (61.7)
8	803 x 310 x 290	31.6 x 12.2 x 11.4	50 (110.2)
9A	1108 x 310 x 290	43.6 x 12.2 x 11.4	66.5 (146.6)
9E/10E	1069 x 310 x 290	42.1 x 12.2 x 11.4	46 (101.4)
9D/10D	Rectifier 355 x 310 x 290	Rectifier 15.8 x 12.2 x 11.4	-
	Inverter 773 x 310 x 290	Inverter 30.4 x 12.2 x 11.4	
11E	1242 x 310 x 312	48.9 x 12.2 x 12.3	63 (138.9)
12T	1750 x 295 x 526	68.9 x 11.6 x 20.7	130 (287)

## Retrofit brackets

To allow an F600 to be fitted in existing Unidrive SP and Affinity surface mount installations.

Frame size	Order code
4	3470-0062
5	3470-0066
6	3470-0074
7	3470-0078
8	3470-0087
9A, 9E, & 10	3470-0118

## Through-hole IP65 kits

Frame size	Order code
3	3470-0053
4	3470-0056
5	3470-0067
6	3470-0055
7	3470-0079
8	3470-0083

## Through-hole IP55 kits

Frame size	Order code
9A	3470-0119
9E/10E	3470-0105
10 Inverter	3470-0108
10 Rectifier	3470-0106
11E & 11T	3470-0126
11D Inverter	3470-0130
11 Rectifier	3470-0123

## Option modules

Option module	Order code
SI-PROFIBUS	82400000017500
SI-Ethernet	82400000017900
SI-EtherCAT	82400000018000
SI-DeviceNet	82400000017700
SI-CANopen	82400000017600
SI-PROFINET RT	82400000018200
SI-Applications Plus	82400000016500
MCi200	82400000017000
SI-I/O	82400000017800

## Tile mount kit

Frame size	Order code
3	3470-0049
4	3470-0060
5	3470-0073

## General kit items

Item	Order code
Frame size 3 & 4 power connector split kit	3470-0064

## Optional media and accessories

Description	Order code
SD-Smartcard Adaptor	3470-0047
Smartcard (64KB)	2214-0010

## DC bus paralleling kits

Frame size	Order code
3	3470-0048
4	3470-0061
5	3470-0068
6	3470-0063
6 (connect to frame 3,4 & 5)	3470-0111

## Line reactors

Frame size	Order code
9E 200 V/400 V	4401-0181
9E 575 V/690 V	4401-0183
10E 200 V/400 V	4401-0182
10E 575 V/690 V	4401-0184

## UL type 1 conduit kits

Frame size	Order code
3&4	6521-0071
5	3470-0069
6	3470-0059
7	3470-0080
8 & 9A	6500-0106
9E & 10E	3470-0115
11	3470-0136

## Optional external EMC filters

The F600's built-in EMC filter complies with EN 61800-3\*. External EMC filters are required for compliance with EN 61000-6-4.

Frame size	Voltage	Order code
3	200 V	4200-3230
	400 V	4200-3480
4	200 V	4200-0272
	400 V	4200-0252
5	200 V	4200-0312
	400 V	4200-0402
6	575 V	4200-0122
	200 V	4200-2300
7	400 V	4200-4800
	575 V	4200-3690
8	200 V	4200-1132
	400 V	4200-1132
9A	575 V	4200-0672
	690 V	4200-0672
9E & 10E	200 V	4200-1972
	400 V	4200-1972
11	575 V	4200-1662
	690 V	4200-1662
11	200 V	4200-3021
	400 V	4200-3021
11	575 V	4200-1660
	690 V	4200-1660
11	200 V	4200-4460
	400 V	4200-4460
11	575 V	4200-2210
	690 V	4200-2210
11	400 V	4200-0400
	575 V & 690 V	4200-0690

\*For more detailed information please see technical documents.