

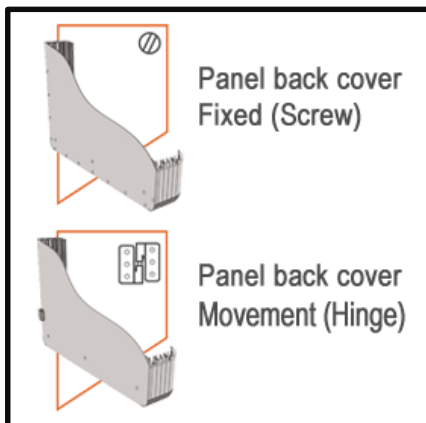

ISO9001  

ECO.1590.0100

Panel Systems



Weight (gr)	-
Color / Ral Code	Aluminium Anodized
Package	1
Package Dimension (mm)	440x380x260
Material	Aluminium

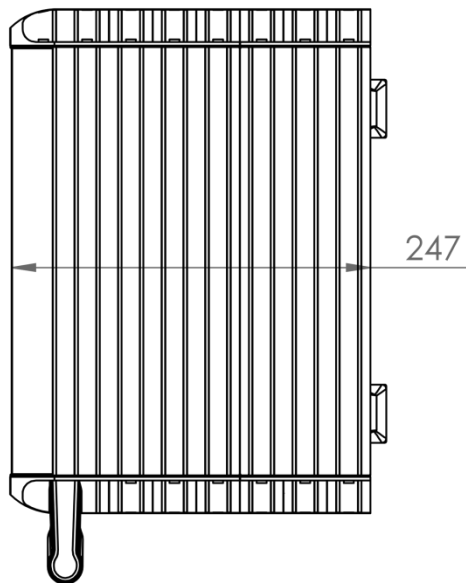
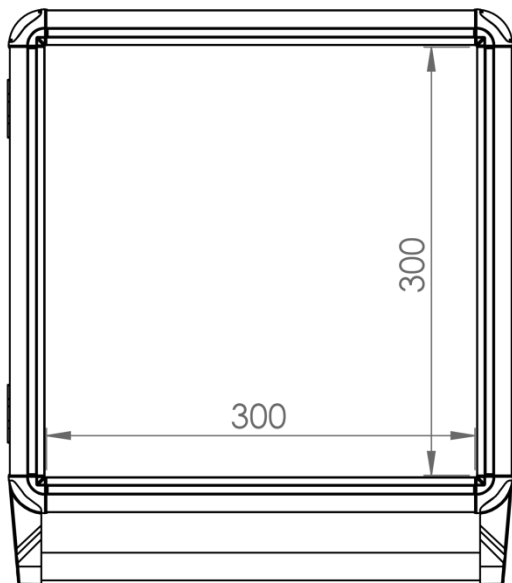

Installation Area			Back Area		Installation Depth		Support Arm No. TK		Order No
Weight mm	Height mm	Depth mm	Hinge	Screw	H Profile installation platform	Installation Deep mm	130 mm \varnothing	118 x 65.5 mm 	
300	300	240	Yes	-	Yes	217	Yes	-	1590-0104
300	300	240	-	Yes	-	240	Yes	-	1590-0105
300	400	240	Yes	-	Yes	217	Yes	-	1590-0106
300	400	240	-	Yes	-	240	Yes	-	1590-0107
400	400	240	Yes	-	Yes	217	Yes	-	1590-0108
400	400	240	-	Yes	-	240	Yes	-	1590-0109
400	500	240	Yes	-	Yes	217	Yes	-	1590-0110
400	500	240	-	Yes	-	240	Yes	-	1590-0111
500	500	240	Yes	-	Yes	217	Yes	-	1590-0112
500	500	240	-	Yes	-	240	Yes	-	1590-0113
500	600	240	Yes	-	Yes	217	Yes	-	1590-0114
500	600	240	-	Yes	-	240	Yes	-	1590-0115
600	600	240	Yes	-	Yes	217	Yes	-	1590-0116
600	600	240	-	Yes	-	240	Yes	-	1590-0117