

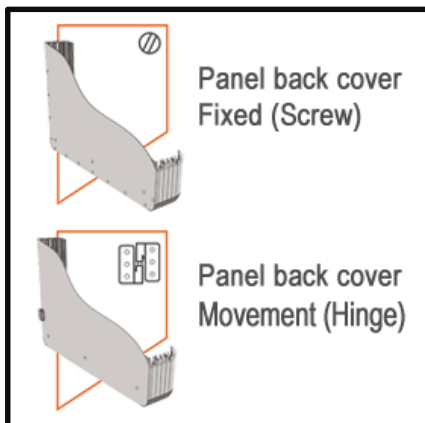

ISO9001  

ECO.1591.0000

Panel Systems



Weight (gr)	-
Color / Ral Code	Aluminium Anodized
Package	1
Package Dimension (mm)	440x380x260
Material	Aluminium

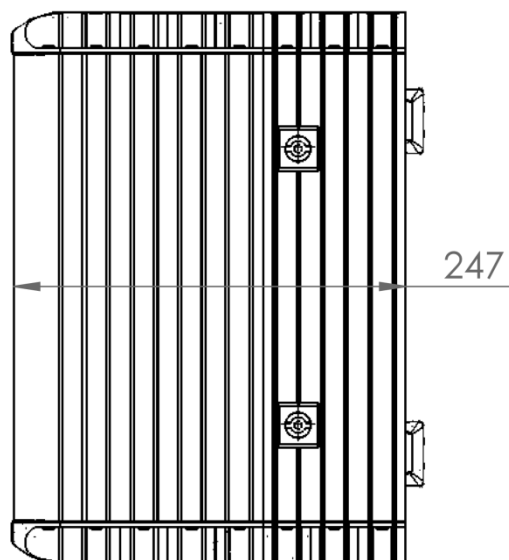
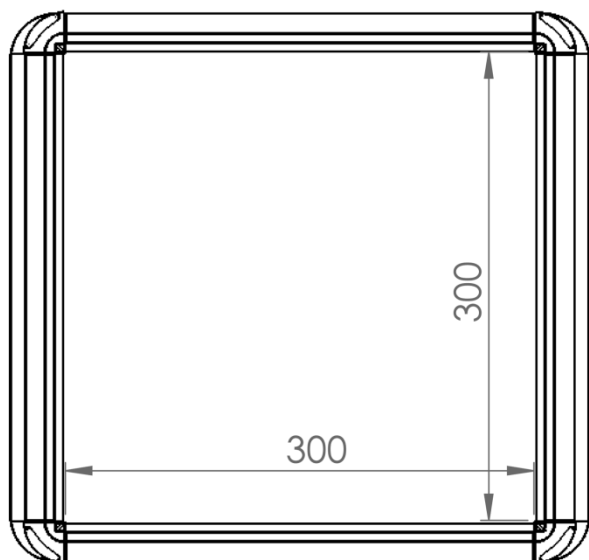

Installation Area			Back Area		Installation Depth		Support Arm No. TK		Order No
Weight mm	Height mm	Depth mm	Hinge	Screw	H Profile installation platform	Installation Deep mm	130 mm \varnothing	118 x 65.5 mm 	
300	300	240	Yes	-	Yes	217	Yes	-	1591-0004
300	300	240	-	Yes	-	240	Yes	-	1591-0005
300	400	240	Yes	-	Yes	217	Yes	-	1591-0006
300	400	240	-	Yes	-	240	Yes	-	1591-0007
400	400	240	Yes	-	Yes	217	Yes	-	1591-0008
400	400	240	-	Yes	-	240	Yes	-	1591-0009
400	500	240	Yes	-	Yes	217	Yes	-	1591-0010
400	500	240	-	Yes	-	240	Yes	-	1591-0011
500	500	240	Yes	-	Yes	217	Yes	-	1591-0012
500	500	240	-	Yes	-	240	Yes	-	1591-0013
500	600	240	Yes	-	Yes	217	Yes	-	1591-0014
500	600	240	-	Yes	-	240	Yes	-	1591-0015
600	600	240	Yes	-	Yes	217	Yes	-	1591-0016
600	600	240	-	Yes	-	240	Yes	-	1591-0017