

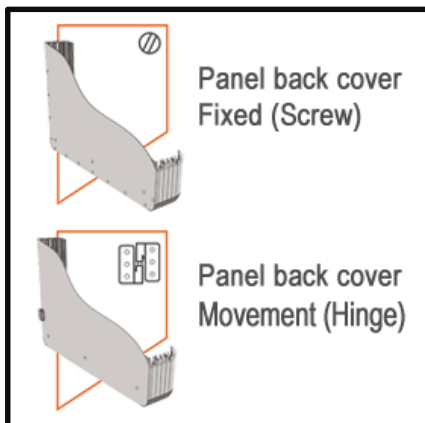

ISO9001  

# ECO.6090.0200

Panels Systems



Weight (gr)	-
Color / Ral Code	Aluminium Anodized
Package	1
Package Dimension (mm)	440x380x200
Material	Aluminium

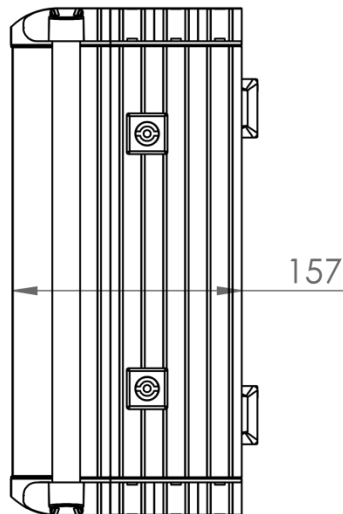
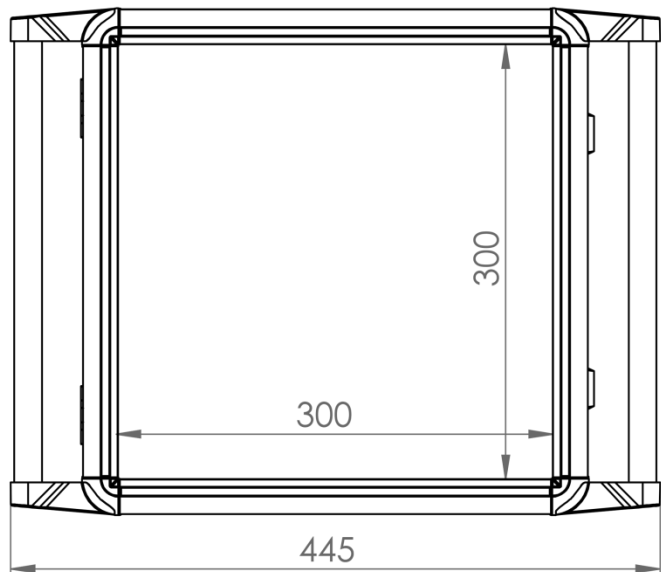

Installation Area			Back Area		Installation Depth		Support Arm No. TK		Order No
Weight mm	Height mm	Depth mm	Hinge	Screw	H Profile installation platform	Installation Deep mm	130 mm $\varnothing$	118 x 65.5 mm 	
300	300	150	Yes	-	Yes	127	-	Yes	6090-0204
300	300	150	-	Yes	-	150	-	Yes	6090-0205
300	400	150	Yes	-	Yes	127	-	Yes	6090-0206
300	400	150	-	Yes	-	150	-	Yes	6090-0207
400	400	150	Yes	-	Yes	127	-	Yes	6090-0208
400	400	150	-	Yes	-	150	-	Yes	6090-0209
400	500	150	Yes	-	Yes	127	-	Yes	6090-0210
400	500	150	-	Yes	-	150	-	Yes	6090-0211
500	500	150	Yes	-	Yes	127	-	Yes	6090-0212
500	500	150	-	Yes	-	150	-	Yes	6090-0213
500	600	150	Yes	-	Yes	127	-	Yes	6090-0214
500	600	150	-	Yes	-	150	-	Yes	6090-0215
600	600	150	Yes	-	Yes	127	-	Yes	6090-0216
600	600	150	-	Yes	-	150	-	Yes	6090-0217