

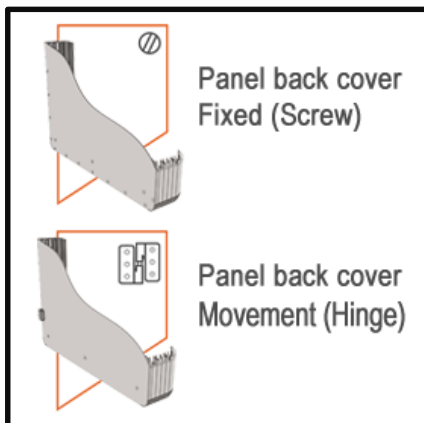

ISO9001 CE c UL US LISTED

ECO.6091.0000
Panels Systems



Weight (gr)	-
Color / Ral Code	Aluminium Anodized
Package	1
Package Dimension (mm)	440x380x200
Material	Aluminium

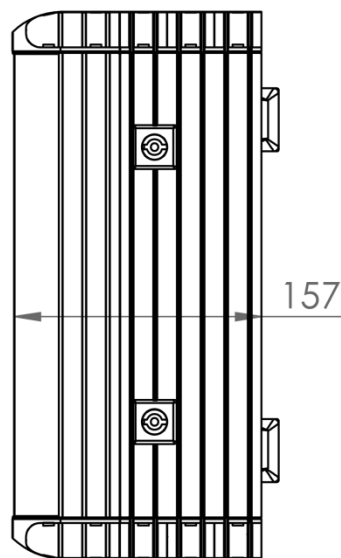
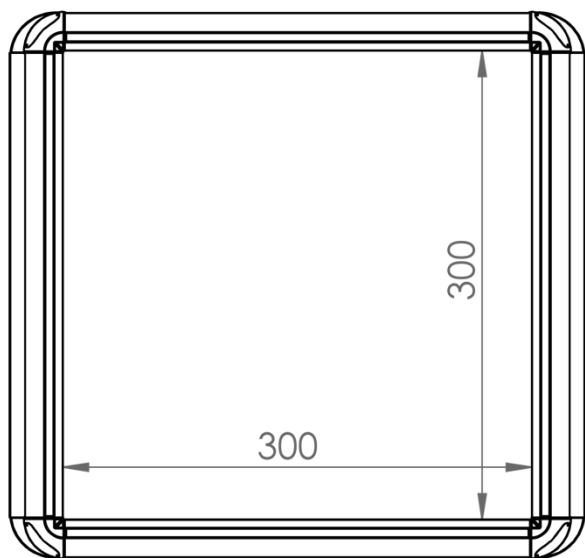

Installation Area			Back Area		Installation Depth		Support Arm No. TK		Order No
Weight mm	Height mm	Depth mm	Hinge	Screw	H Profile installation platform	Installation Deep mm	130 mm Ø	118 x 65.5 mm	
300	300	150	Yes	-	Yes	127	-	Yes	6091-0004
300	300	150	-	Yes	-	150	-	Yes	6091-0005
300	400	150	Yes	-	Yes	127	-	Yes	6091-0006
300	400	150	-	Yes	-	150	-	Yes	6091-0007
400	400	150	Yes	-	Yes	127	-	Yes	6091-0008
400	400	150	-	Yes	-	150	-	Yes	6091-0009
400	500	150	Yes	-	Yes	127	-	Yes	6091-0010
400	500	150	-	Yes	-	150	-	Yes	6091-0011
500	500	150	Yes	-	Yes	127	-	Yes	6091-0012
500	500	150	-	Yes	-	150	-	Yes	6091-0013
500	600	150	Yes	-	Yes	127	-	Yes	6091-0014
500	600	150	-	Yes	-	150	-	Yes	6091-0015
600	600	150	Yes	-	Yes	127	-	Yes	6091-0016
600	600	150	-	Yes	-	150	-	Yes	6091-0017