

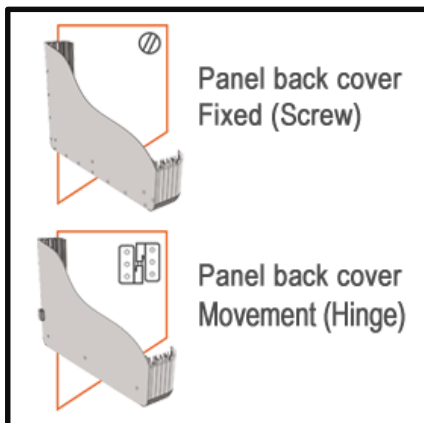

ISO9001  

# ECO.6091.0100

Panels Systems



Weight (gr)	-
Color / Ral Code	Aluminium Anodized
Package	1
Package Dimension (mm)	440x380x200
Material	Aluminium

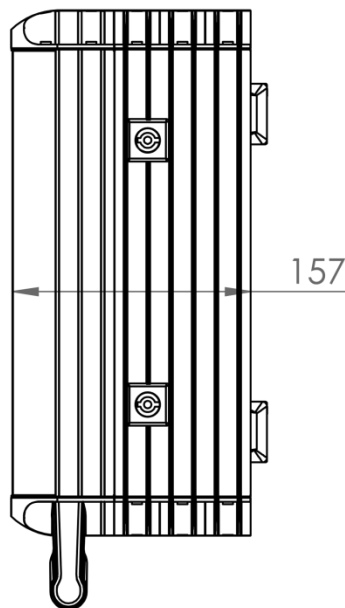
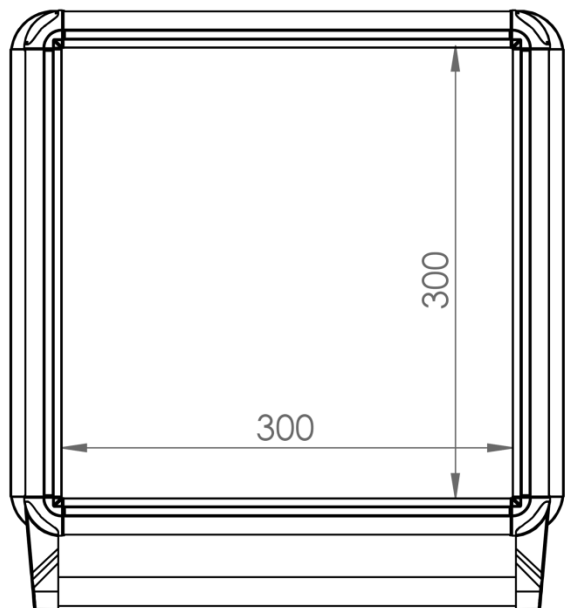

Installation Area			Back Area		Installation Depth		Support Arm No. TK		Order No
Weight mm	Height mm	Depth mm	Hinge	Screw	H Profile installation platform	Installation Deep mm	130 mm $\varnothing$	118 x 65.5 mm 	
300	300	150	Yes	-	Yes	127	-	Yes	6091-0104
300	300	150	-	Yes	-	150	-	Yes	6091-0105
300	400	150	Yes	-	Yes	127	-	Yes	6091-0106
300	400	150	-	Yes	-	150	-	Yes	6091-0107
400	400	150	Yes	-	Yes	127	-	Yes	6091-0108
400	400	150	-	Yes	-	150	-	Yes	6091-0109
400	500	150	Yes	-	Yes	127	-	Yes	6091-0110
400	500	150	-	Yes	-	150	-	Yes	6091-0111
500	500	150	Yes	-	Yes	127	-	Yes	6091-0112
500	500	150	-	Yes	-	150	-	Yes	6091-0113
500	600	150	Yes	-	Yes	127	-	Yes	6091-0114
500	600	150	-	Yes	-	150	-	Yes	6091-0115
600	600	150	Yes	-	Yes	127	-	Yes	6091-0116
600	600	150	-	Yes	-	150	-	Yes	6091-0117