

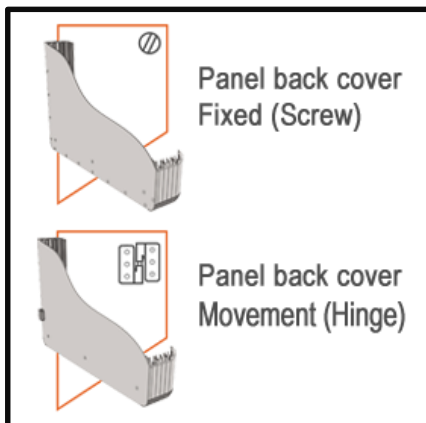

ISO9001 CE cUL US LISTED

ECO.9091.6000

Panel Systems



Weight (gr)	-
Color / Ral Code	Aluminium Anodized
Package	1
Package Dimension (mm)	430x380x200
Material	Aluminium

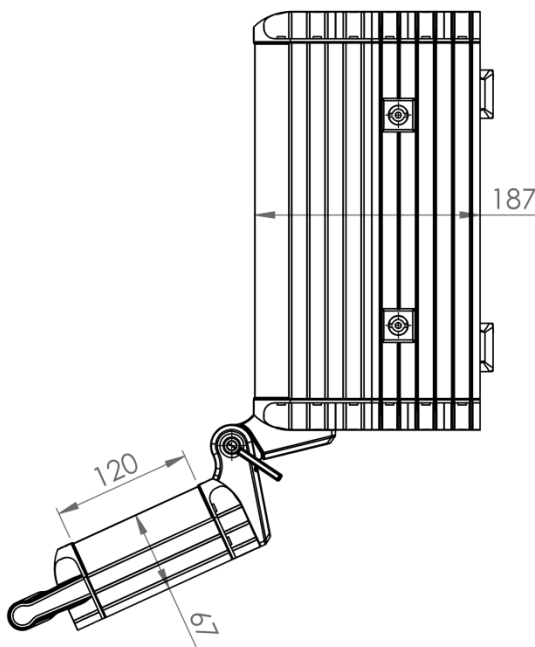
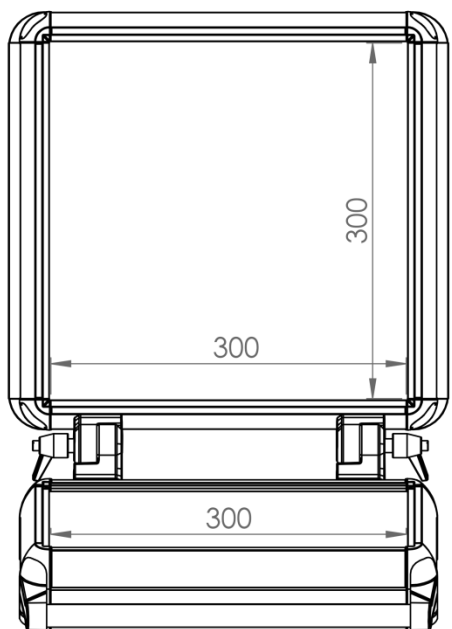

Installation Area			Back Area		Intallation Depth		Support Arm No. TK		Order No
Weight mm	Height mm	Depth mm	Hinge	Screw	H Profile installation platform	Installation Deep mm	130 mm \varnothing	118 x 65.5 mm 	
300	300	180	Yes	-	Yes	157	-	Yes	9091-6004
300	300	180	-	Yes	-	180	-	Yes	9091-6005
300	400	180	Yes	-	Yes	157	-	Yes	9091-6006
300	400	180	-	Yes	-	180	-	Yes	9091-6007
400	400	180	Yes	-	Yes	157	-	Yes	9091-6008
400	400	180	-	Yes	-	180	-	Yes	9091-6009
400	500	180	Yes	-	Yes	157	-	Yes	9091-6010
400	500	180	-	Yes	-	180	-	Yes	9091-6011
500	500	180	Yes	-	Yes	157	-	Yes	9091-6012
500	500	180	-	Yes	-	180	-	Yes	9091-6013
500	600	180	Yes	-	Yes	157	-	Yes	9091-6014
500	600	180	-	Yes	-	180	-	Yes	9091-6015
600	600	180	Yes	-	Yes	157	-	Yes	9091-6016
600	600	180	-	Yes	-	180	-	Yes	9091-6017